



Instructions for use

Shower stretcher & changing table

Important:

Read these instructions carefully before using the table!

date of first use

.....

User

.....

Name

.....

Address

.....

Manufactured by:

Lopital Nederland B.V.
Laarakkerweg 9
5061 JR Nederland
T (0031) 13 52 39 300
F (0031) 13 52 39 301
www.lopital.nl
info@lopital.nl

Index

Introduction	4
Warranty	4
Safety	4
Features	5
Emergency stop	5
Folding up the shower stretcher/changing table	5
Operating the side panel	6
Water drainage	6
Changing the battery	7
Charging the battery	7
Maintenance	8
Technical specifications	8
Installation	9

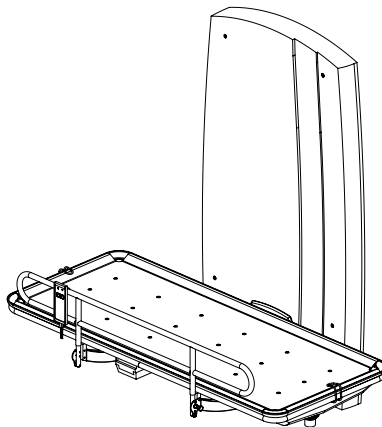

Introduction

The shower stretcher/changing table is an aid to the ergonomically responsible washing of residents under running water and/or supporting those who have poor balance while seated. The shower stretcher/changing table is user-friendly, maintenance-friendly, attractive, generous height-adjustable and, above all, safe for users and carers. The wall section can be moved up or down electrically and is multifunctional. Placing this generously height-adjustable shower stretcher/changing table at the ideal height makes it easy to transfer from other furniture and aids such as beds, stretchers, shower/toilet and wheelchairs.

Warranty

Lopital Nederland B.V. is proud that you have chosen a high quality aid. Many years of experience in the development and production of bathroom, toilet and shower aids have made Lopital Nederland B.V. a leading company in this sector. The shower stretcher/changing table meets the CE safety standards. These standards conform to the Medical Devices Directive of 14 June 1993 no. 93/42 EEG. All Lopital Nederland B.V. shower aids come with a 2-year manufacturer's warranty. Normal wear and tear and improper use do not fall under the terms of this warranty. Lopital Nederland B.V. does not accept any liability for personal injury, which is caused by the improper use of the shower stretchers.

Safety

Ensure that the shower stretcher/changing table is installed in accordance with the attached drawings and instructions. It is preferable to have the shower stretcher/changing table installed by a recognised professional. The shower stretcher can only be mounted on a wall with sufficient strength. In all other cases you must apply reinforcement of sufficient strength or fasten the shower stretcher/changing table to the wall with locking plates (only on walls with sufficient thickness). Lopital Nederland B.V. can also supply a separate console as a solution for walls with insufficient strength. These are fastened between the floor and the ceiling.

If you have any questions or repairs are required please contact your dealer.



Attention: When folding the stretcher and/or the side panel up or down avoid the hinge point in order to prevent your fingers becoming trapped.

Features

- High/Low wall section can be used universally
- Large range: 60 cm
- Lowest position of the stretcher is approximately 40cm above the floor
- Fast lifting speed
- Modern design
- Low noise production
- Flat surfaces make it simple to clean
- No Sharp edges or protruding parts
- The stretcher is easy to fold up

Emergency stop

- An emergency stop is located on the control box under the stretcher/changing table.
- Press the emergency stop during an emergency. This will immediately halt the upward or downward motion.
- The high/low control will not function after the emergency stop has been pressed.
- To resume control, turn the emergency stop a quarter turn to the right to unlock it.

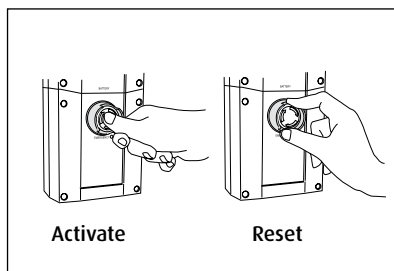

Folding up the shower stretcher/changing table

When you need to fold the shower stretcher/changing table up, you must first fold the side panel down. When folding the shower stretcher/changing table down, first pull the shower stretcher/changing table forward and fold the side panel up. It will fall into the locked position automatically.

Operating the side panel

- The shower stretcher/changing table can be fitted with a side panel as an option.
- The side panel is fitted with a panel safety feature that prevents users from lifting the side panel independently.
- Before the side panel can be folded down the panel safety feature must be unlocked.
- Unlock the safety feature by pulling the protruding lip (1) out with one hand and lifting the middle of the side panel up with the other hand.
- Turn the unlocked panel outwards.
- With folded down side panels it is possible for the carer to lean against the middle of the stretcher/changing table in order to deliver care more effectively.
- To fold the side panel up, turn the side panel up again. The panel locks automatically.
- 61002400/01: Ensure that the corner flaps fall inwards so that they do not become trapped in the panel lock.

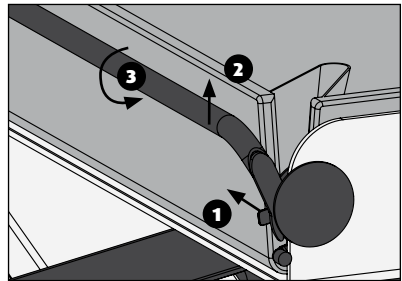
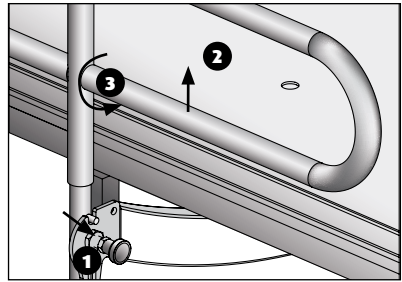

Water drainage

The drainage hose is used to lead the water from the shower stretcher to a drain. Lead the drainage hose to a drainage point at a low level.

Changing the battery

- The battery is fully charged when all the boxes in the display on the control box are black.
- As soon as a plug symbol is displayed the battery must be changed and charged.
- To remove the battery, unlock the pole (1) on the battery with one hand and then remove the battery (2).
- Before inserting the fully charged battery, first place the battery against the housing of the electronics and then click it into the holder.

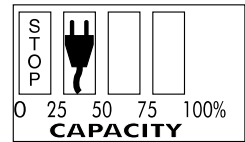

Comments: Ensure that the stretcher/changing table is always ready for use by having a fully charged battery in reserve.

Charging the battery

- Place the empty battery on the battery charger.
- A green light indicates that the battery charger is active, an orange light indicates that charging is taking place. This light switches off when the battery is charged.
- The charged battery can remain on the battery charger without this causing damage.
- To remove the battery, unlock the pole on the battery with one hand while supporting the battery with the other hand.

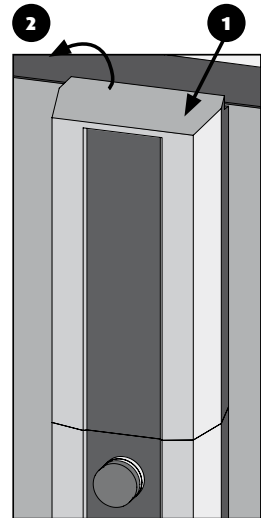

Comments: Only use the batteries that are supplied with the stretcher/changing table. Charge batteries that are not in use every six months in order to prevent damage. Charging batteries before they are completely empty will extend their life span.



Important!

Never use the battery charger in the bathroom or in a humid environment!

Maintenance

- The shower stretcher/changing table must be cleaned with normal household cleaning agents after every use. Do not use abrasive or other aggressive solvents (such as chlorine).
- If the stretcher/changing table must be disinfected we recommend Neoquat combi®, not combined with alcohol.
- Remove excess soap remnants.
- For optimum and efficient cleaning of the mattress and surface, the mattress can be lifted and removed. (only 61002400/01)
- Dry the base on which the mattress is lying. (only 61002400/01)
- Ensure that the battery is charged.
- Lopital Nederland B.V. recommends that you take out an annual maintenance contract for the shower stretcher/changing table.
- Maintenance and repairs should only be executed by authorised staff.

Technical specifications

Maximum permitted load:		135 kg
Dead weight:	62005005/10	85 kg
	65005015/20	75 kg
	61002400/01	80 kg

Wall section data

Wall frame	Steel electrolytically galvanised
High/Low profiles	Stainless steel tube profile
Stretcher suspension point	Stainless steel, powder coated
Screw parts	Stainless steel
Plastic protective cap	ABS
Lifting capacity	135 kg
Travel length	600 mm
Speed	minimum 14 mm/s at maximum load

Drive unit data

Utilised capacity	120W
Drive operates on low Voltage	24VDC
Protection factor	IP 66

Installation

Determining the working height

The shower stretcher/changing table allows carers to adjust it to the optimum ergonomic working height with an adjustment range of 60 cm. The minimum height of the surface of the stretcher is 40 cm from the floor. The maximum height of the surface depends on the height of the bathroom.

Maximum height stretcher surface = Height bathroom (minimum 230 cm) – 130 cm. Draw the hole pattern on the wall in accordance with the attached installation drawing.

We recommend drawing the bottom two holes at a height of 77 cm above the tiled floor, which creates a working height range for the surface of the stretcher from 40 - 50 cm to 100 - 110 cm from the tiled floor.

Preparation for installation

- The wall where the shower stretcher/changing table is to be mounted must be at least 2.3 metres wide and 2.3 metres high and free of obstacles.
- Draw a plumb line on the bathroom wall where the middle of the shower stretcher/changing table must be. Keep a minimum of 1.15 metres on both sides of this line free of obstacles.
- Drill the holes at the locations marked on the wall.

Wall mounting

- Fasten the wall frame with the fasteners that are appropriate for this wall. Ensure that the tubes of the wall frame are level.
- If you have ordered the 61002400/01 first fit the fixed side panel to the black panels of the wall frame.
- Fit the shower stretcher/changing table to the wall frame. First fasten the gas springs and then the hinge points.
- Fit the cover cap last and check that the cap does not touch the wall, ceiling, floor or skirting board, and that cables are not trapped. The stretcher/changing table must not be obstructed by any obstacle.



A drain with a minimum diameter of 40 mm must be present under the stretcher in the bathroom.

To be fitted outside the bathroom:

Battery charger with wall panel, near a wall socket 230 V (AC)

Installation plan

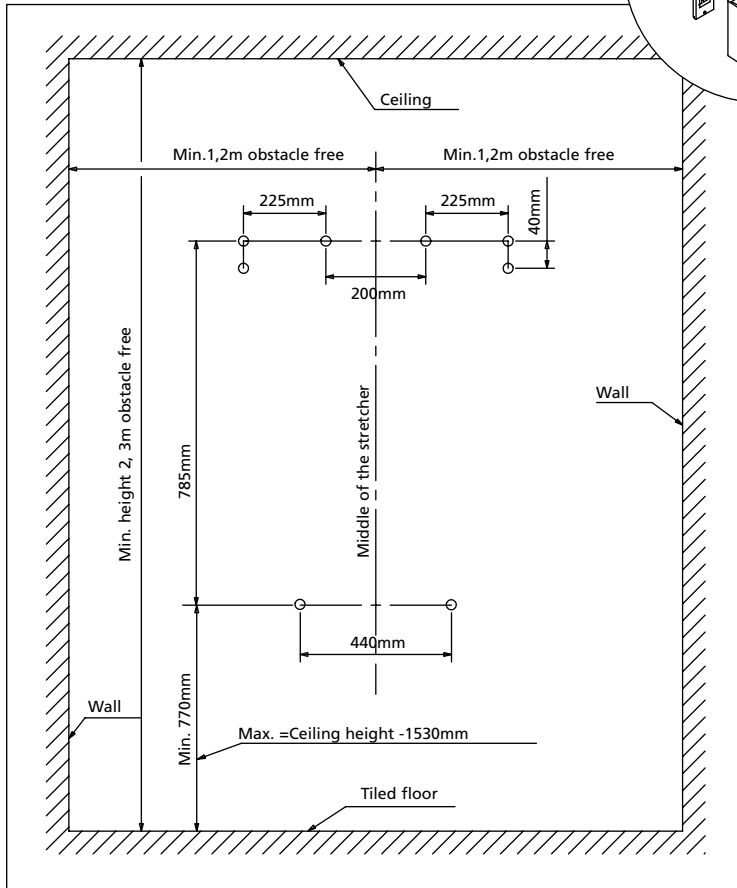



For more information, please visit our website: www.lopital.com

Lopital Nederland B.V. Laarakkerweg 9, 5061 JR Oisterwijk, Postbus 56, 5060 AB Oisterwijk
Tel 013 5239300, Fax 013 5239301, E-mail info@lopital.nl, www.lopital.nl

