

LECKEY[®]

Kidwalk Seating System
User Instructions





The Kidwalk has been designed as a posturally supportive mobility system that moves with the child giving them the freedom to move and walk while keeping their hands free to explore their surroundings. This manual shows you how you can quickly and easily make use of all of the functions. The instructions on the safety and maintenance of the product will ensure that you will enjoy the use of this product for a long time.

Contents

- 01 Intended use
- 02 Declaration of conformity
- 03 Terms of warranty
- 04 Product history record
- 05 Product training record
- 06 Safety information
- 07 How to unpack and assemble
- 08 Clinical setup for postural management
- 09 Frequent adjustments for daily use
- 10 Cleaning & care information
- 11 Daily product inspection
- 12 Annual product inspection
- 13 Reissuing Leckey products
- 14 Product servicing
- 15 Technical information

1. Intended Use

The Kidwalk is the first partial weight bearing, posturally supportive mobility system that is designed to move with the child, giving them the freedom to move and walk while keeping their hands free explore their surroundings. The Kidwalk is available in two sizes. Size 1 caters for children aged 1-7 years and Size 2 for children aged 5-12 years, the size one having a maximum user weight of 30kgs (65lbs) and the size two 50kgs (110lbs).

2. Declaration of Conformity

James Leckey Design Ltd. as authorised representative for Axiom Industries Inc. (Prime Engineering) declares that the Kidwalk conforms to the requirements of the 93/42/ EEC Guidelines and EN12182 Technical aids for disabled persons general requirements and test methods.

3. Terms of Warranty

The warranty applies only when the product is used according to the specified conditions and for the intended purposes, following all manufacturers' recommendations (also see general terms of sales, delivery and payment). A two year warranty is provided on all Leckey products and components.

4. Product History Record

Your Leckey product is classified as a Class 1 Medical device and as such should only be prescribed, set up or reissued for use by a technically competent person who has been trained in the use of this product. Leckey recommend that a written record is maintained to provide details of all set ups, reissue inspections and annual inspections of this product.

5. Product Training Record

(Parents, Teachers & Carers)

Your Leckey product is a prescribed Class 1 Medical Device and as such Leckey recommend that parents, teachers and carers using the equipment should be made aware of the following sections of this user manual by a technically competent person:

Section 6
Safety Information

Section 9
Frequent Adjustments for Daily use

Section 10
Cleaning and Care

Section 11
Daily Product Inspection

Leckey recommend that a written record is maintained of all those who have been trained in the correct use of this product.

6 Safety Information



6.1 Always read instructions fully before use.



6.2 Users should not be left unattended at any time whilst using Leckey equipment.



6.3 Only use Leckey approved components with your product. Never modify the product in any way. Failure to follow instructions may put the user or carer at risk and will invalidate the warranty on the product.



6.4 If in any doubt to the continued safe use of your Leckey product or if any parts should fail, please cease using the product and contact our customer services department or your local dealer as soon as possible.



6.5 We would recommend that users are never transferred straight from seating to standing or walking without preparation and stretching. This is best done whilst lying on a mat but can be carried out in a wheelchair or seating system if required.



6.6 Carry out all positional adjustments and ensure that they are securely fastened before you put the user into this product.



6.7 Whilst the user is in the frame all safety straps must be fastened securely.



6.8 Never leave the product on a sloping surface, greater than 5 degrees.



6.9 The product contains components which could present a choking hazard to small children. Always check that locking knobs and bolts within the child's reach are tightened and secure at all times.



6.10 Leckey products comply with fire safety regulations in accordance with EN12182. However the product contains plastic components and therefore should be kept away from all direct sources of heat including naked flames, cigarettes, electric and gas heaters.



6.11 Clean the product regularly. Do not use abrasive cleaners. Carry out maintenance checks on a regular basis to ensure your product is in good working condition.



6.12 The product is designed for indoor and outdoor use and when not in use should be stored in a dry place that is not subjected to extremes of temperature. The safe operating temperature range of the product is +5 to +40 deg Celsius.

How to unpack and assemble the Kidwalk

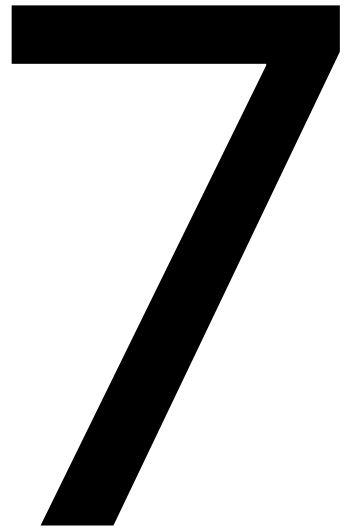

Check parts

Congratulations on purchasing your Kidwalk. Your Kidwalk comes as standard with a base assembly, mast assembly, two wheels, two axles and two axle spacers (Size 1 only). The axles and axle spacers will be in a sealed plastic bag. Other optional accessories that you may have ordered will also be packed in the box in separate plastic bags. Carefully remove all the parcels from the box and check you have all the parts you have ordered.



Safety First

Keep polythene bags away from children.

Assembling the Kidwalk

To assemble your Kidwalk firstly open the box and remove and identify the following parts:

1 Base Frame assembly with anti tippers



2 Mast assemblies



3 Wheels



4 Plastic bag containing axles and spacers



5 Any other optional accessories ordered

7.1 Attaching and Removing the wheels

First press the button at the end of the axle and remove the spacer (A) (Size 1 only). Push the button (B) at the end of the axle to allow the axle to slide through the wheel bearings. The axle should be inserted from the recessed side of the wheel. Once inserted, release the button and the wheel is secure. For size 1 the spacer should then be replaced onto the axle. Repeat this procedure on the other wheel.

There are three mounting positions (C) for the large wheels. While pressing the axle button, insert the axle into one of these positions. Make sure that the axle has fully engaged and release button.

To remove the wheels, press the axle button and slide the wheel and axle off the frame.

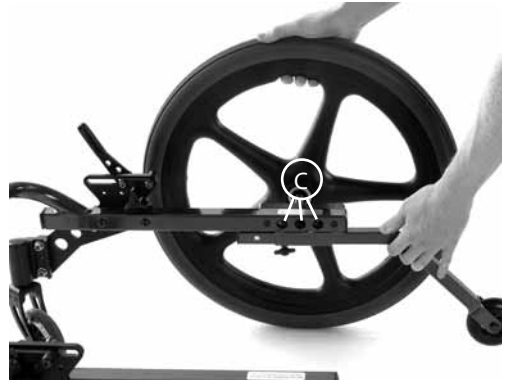

7.2 Changing the wheel position

Move the wheel lock before changing the wheel position.

The wheel lock is pre-set to the centre wheel position. To change the position of the wheel lock, remove the thumb screw (A). Move the wheel lock forward or rearward to coincide with the new wheel position. Align the threaded hole for the thumb screw with the front or the rear hole. Attach the thumb screw and tighten securely.

There are three mounting positions (B) for the large wheels. To move the wheels to a new location pull outward on the wheel while pressing the axle pin button and remove the wheel from the frame. While pressing the axle button, insert into a new location. After locating the wheel make sure that the axle has fully engaged.



Safety first

Make sure the wheel locks are adjusted and able to be locked properly prior to use.

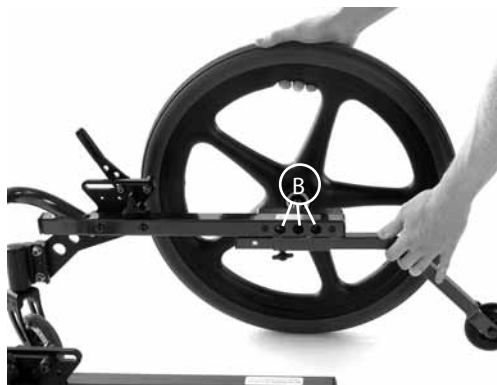

7.3 Attaching the Mast assembly

Locate the mast release pin (A) on the base frame. Pull the pin outward and twist until the pin is in the locked out position.

Place the mast assembly over the locator pins (B) on the base assembly. Rotate the locking pin until it engages into the mast assembly. Ensure that the mast pin is fully engaged and holding the mast firmly to the base. If the mast lifts up from the base, twist the retaining pin again until it snaps securely into the mast.



You must ensure that the locking pin is secured before the user is placed in the frame.



7.4 Attaching the lateral chest system

To attach the lateral chest system, slide the extension tube at the back of the lateral chest system into the top of the receiver tube (A) on the mast assembly. Set the pads at the required height and tighten both adjustment screws (B).



7.5 Attaching the headpad

Insert the extension tube into the receiver tube on the lateral chest system, set at the required height and secure with screw (A), then insert the headpad into the extension tube with the pad facing forward and tighten the adjustment screw (B) securely.

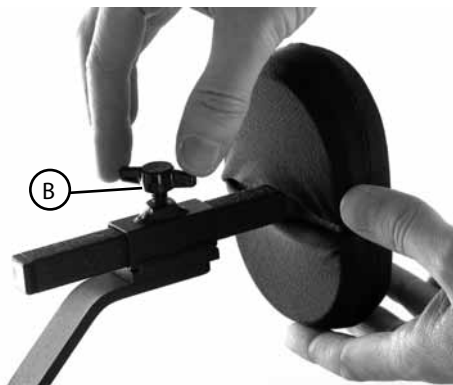

7.6 Attaching the cruiser wheels

Remove the anti-tip levers from the base frame by depressing the push button and sliding forward as far as possible. Press the push button (A) at the end of the anti-tipper and slide out of the base frame completely. Repeat this process to remove the other anti-tipper.

Insert the cruiser wheels and slide into the base frame receiver until it is through the receiver tube. Press the button (A) and slide the tube in until the second button (B) snaps into the correct hole in the frame receiver tube. The correct hole is the one which corresponds to the position of the large wheels.



The Kidwalk must be used with its anti-tippers or cruiser wheels at all times. Please ensure you replace the anti-tippers into the frame when not using the cruiser wheels.

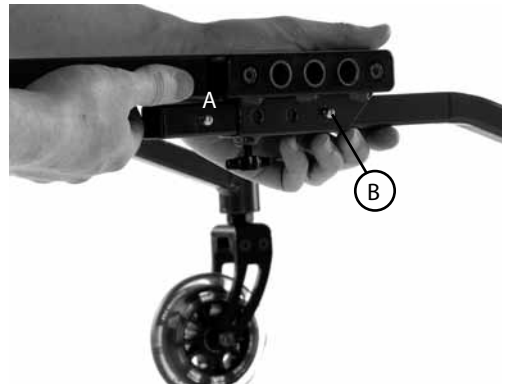
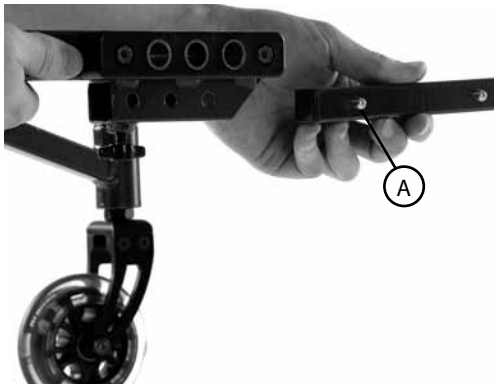

Clinical set up for postural management

The clinical setup of the product should be completed by a technically and clinically competent person who has been trained in the use of the product. Leckey recommend a written record is maintained of all clinical set ups for this product.

We recommend you set up the Kidwalk in the following order:

1. Take child's measurements
2. Adjust seat height
3. Adjust hip support width
4. Adjust lateral chest system
5. Place child into Kidwalk
6. Fine tune hip width
7. Fine tune seat height
8. Adjust mast angle
9. Adjust seat depth

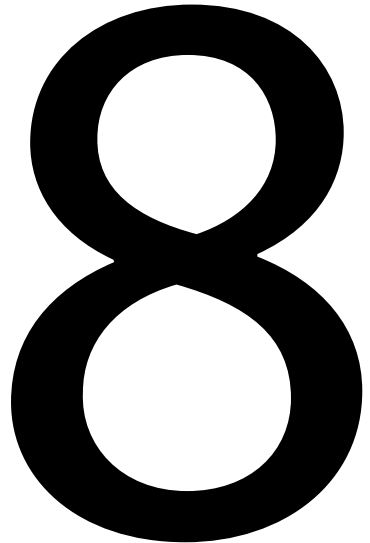

8.1 Measurements and Initial Set Up

To set up the Kidwalk effectively the following measurements should be taken and recorded:

1. Inside leg
2. Hip Width
3. Chest Width
4. Thoracic Height
5. Head Height (to eye level)

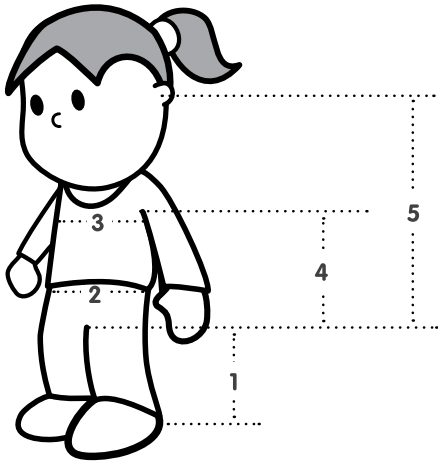

The thoracic height and head height should be taken from the top of the inside leg. These dimensions are needed to set up the Lateral chest system and the various headrests available.

8.2 Adjusting the Seat Height

Using the lift/release handle (A) or the fine tune adjustment handle (B) adjust the seat height to 1" lower than the inside leg measurement. The height can then be fine tuned with the child in the seat.

To raise the seat assembly with the lift/release handle (A) press down on the top of the mast while lifting up on the lift/release handle.

To raise the seat assembly using the fine adjustment, place your hand in the handle and squeeze the lower fine tune handle (B). Each time you squeeze the fine tune handle, the seat will rise up $\frac{1}{2}$ ".

To lower the seat assembly simply press slightly downward on the lift release handle. Minimal pressure is required to slide the seat down the mast. Do not push too hard. Removing downward pressure from the lift release handle will stop the seat from lowering.



8.3 Adjusting the hip support width

Flip the front hip support pads upward and outward. Set the hip pad width to allow the child's hips to be easily placed between the hip pads by turning the knob (A) located on the outside of the hip pad assembly. Turning the knob clockwise makes the assembly wider while anti-clockwise narrows the hip pad width.



8.4 Adjusting the Lateral Chest System

Loosen the knobs (B) on the back side of the upper body pads. Slide the pads outward enough to allow the child to fit between them. Slide all flip up pads forward to allow for child placement and tighten adjustment knobs to temporarily hold them in place.



8.5 Placing the child into the Kidwalk

Firstly lock the wheels then ensure that all hip and lateral supports are high enough and opened wide enough to allow the child to fit between them. Adjust all depth adjustable pads forward far enough to be able to fit the child into the unit when they are flipped down.

Place the child into the unit. Ensure that the child's hips are as far back as possible into the Kidwalk. Once the child is all the way back on the seat, flip the front hip pads towards the child until they are snug and holding their hips in place. Tighten the depth adjustment knobs (A) at the side securely.



8.6 Fine tuning the hip width

Tighten the pelvic supports with the width adjustment knob (A) until the width required is achieved. Snap the buckles together and the strap until tightened. Ensure that the child's hips are positioned as far back onto the seat as possible.



8.7 Fine tuning the seat height

Use the fine tune adjustment handle (A) to move the seat to a height at which the child's feet touch the ground but they are not encouraged to sit on the seat.



8.8 Mast angle adjustment

Once the child has been placed in the Kidwalk and all support surfaces are adjusted properly, it may be necessary to adjust the mast angle. The Kidwalk provides forward and rearward prompting angle adjustment. Move the mast in small increments to assist in positioning the child or facilitate better gait. Turn the Mast angle knob (B) clockwise for more forward angle and anti-clockwise for rearward angle.

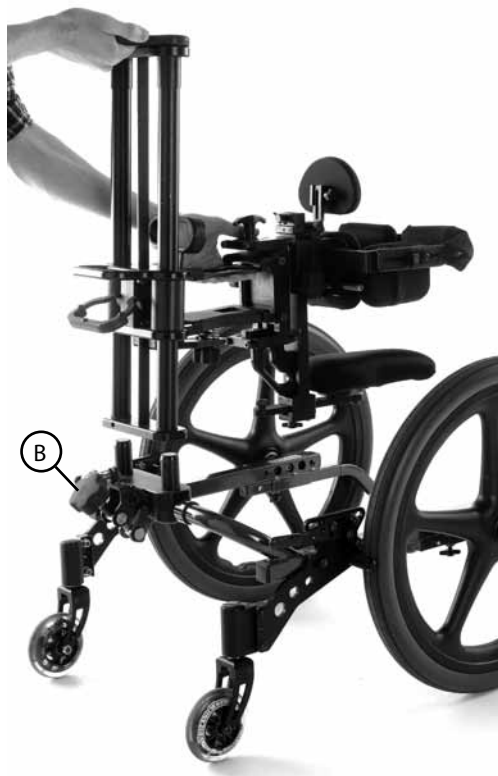

8.9 Seat depth adjustment

The seat has been pre-set to align with the centre axle position on the frame. If it is necessary to alter the depth of the seat, loosen the two adjustment screws (A). Slide the seat forwards or rearward as required and tighten the screws, ensuring that both screws that hold the seat are secure.

8.10 Removing the child

To remove the child from the Kidwalk, first lock the wheels, unfasten the buckles of the forward pads on the hip assembly and lateral chest assembly. Rotate the forward pads upwards and outward to allow clearance to exit and lift the child forward and off the seat.



Frequent adjustment for daily use

Parents and carers should be shown how to make frequent adjustments and made aware of the safety checks in section 6 by a technically and clinically competent person who has been trained in the use of the product. Leckey recommend that a written record is maintained of all parents and carers who have been trained in the use of this product.

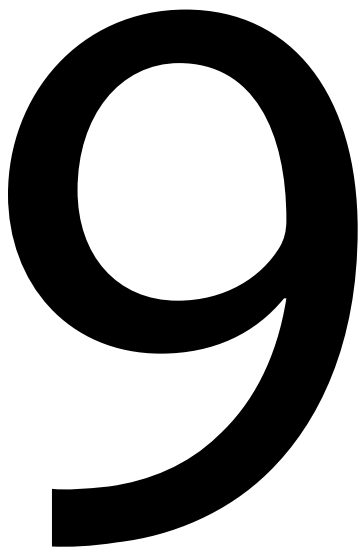

9.1 Adjusting the lateral chest assembly

To adjust the height, loosen the adjustment screw (A), slide the lateral chest system up or down on the extension tube to desired height and tighten the adjustment screw (A) securely.

To adjust the width, loosen the adjustment screws (B), slide the pads inwards, making contact with the body in the desired upper body posture and tighten adjustment screws (B). Flip front lateral pads down into place, snap the buckles together and pull straps securely.

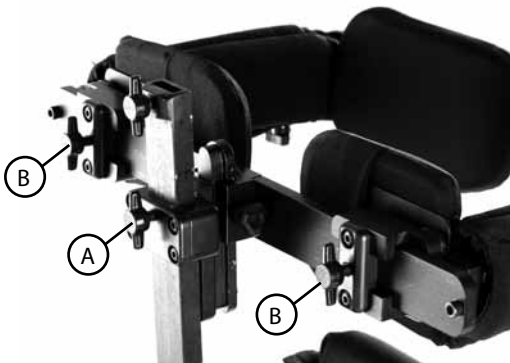

9.2 Adjusting the headpad

Adjust the headpad height and depth by loosening the knobs (C & D), setting to the desired height and depth and retightening.

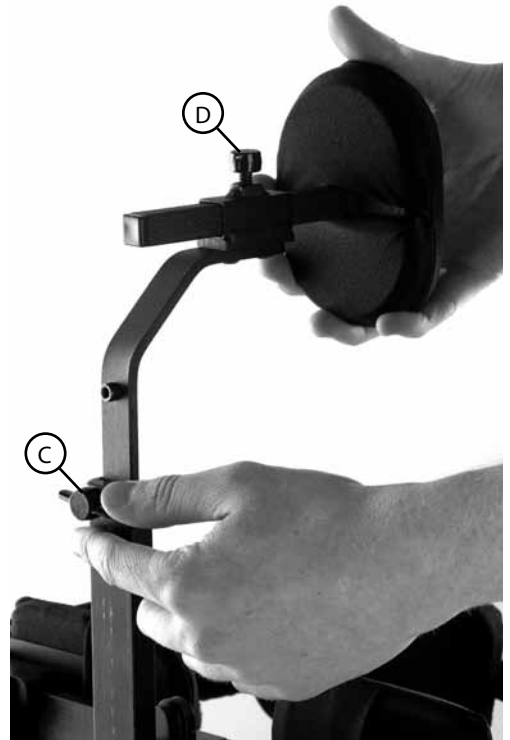

9.3 Transportation and storage

The Kidwalk may be disassembled for ease of transport or storage. If necessary, the large wheels may be removed. See section 7 Attaching and Removing the Wheels.

10 Cleaning & Care Information

How to Maintain

When cleaning the product we recommend that you use only warm water and a nonabrasive detergent. Never use organic solvents or dry cleaning fluids.

Upholstery and fabrics

1. The upholstery and fabrics can be cleaned by hand whilst in place. When cleaning we recommend that you use only warm water and a nonabrasive detergent.

2. Staining should be removed as quickly as possible with absorbent cloth, towels or a sponge. Routine soap and warm water sponging is effective for ordinary soiling and minor spills.

3 Antiseptic cleaning agents can be used on more stubborn stains. These may require a safe solvent such as Isopropyl Alcohol or Mineral Spirit

4 Always ensure the product is dry before use.

Metal and plastic components

1. Soap and water or antibacterial spray can be used for daily cleaning.

2. For deep cleaning a low pressure steam cleaner can be used.

3. Do not use solvents to clean plastic wooden or metal components.

4. Make sure the product is dry before use.

11 Daily Product Inspection

(Therapists, parents & carers)

We recommend that daily visual checks of the equipment are carried out by therapists, carers or parents to ensure the product is safe for use. The recommend daily checks are detailed below.

1. Check the mast is secured to the base frame and the pin is in the locked position.

2. Ensure all adjustment knobs and bolts are in place and secure.

3. Check all upholstery for signs of wear and tear.

4. Check the wheels are moving freely and lock securely.

5. Check all Velcro strips and brush fluff to ensure straps secure firmly. If in any doubt to the continued safe use of your Leckey product or if any parts should fail, please cease using the product and contact our customer services department or your local dealer as soon as possible.

6. Make sure anti-tipper or cruiser wheels are attached securely.

12 Annual Product Inspection

(Therapist, Technician, Leckey Product Advisor, Dealer)

Leckey recommend that each product should be subject to a detailed inspection at least once a year and every time the product is reissued for use. This inspection should be carried out by a technically competent person who has been trained in the use of the product and should include the following checks as a minimum requirement.

1. Check the seat height adjustment mechanism is locking securely.
2. Check the mast is secured to the base frame and the pin is in the locked position.
3. Check all knobs, nuts, bolts, plastic buckles and velcro are in place, replacing any missing items.
4. Lift the base to check each wheel individually. Make sure they are moving freely and remove any dirt from the rubber wheels. Check that the brakes lock the wheels securely.
5. Visually check the structure of the product paying attention to weld points on the frame ensuring there are no signs of fatigue or cracking around the welds.
6. Leckey recommends that a written record is maintained of all annual product inspections. If in any doubt to the continued safe use of your Leckey product or if any parts should fail, please cease using the product and contact our customer services department or your local dealer as soon as possible.
7. Check that the height adjustment mechanism is working and locking securely.

13 Reissuing Leckey products

Most Leckey products are assessed and ordered to meet the needs of an individual user. Before reissuing a product we recommend that the therapist prescribing the product has carried out an equipment compatibility check for the new user and has ensured that the product being re-issued contains no modifications or special attachments.

A detailed technical inspection should be carried on the product prior to re-issuing. This should be carried out by a technically competent person who has been trained in the use and inspection of the product. Please refer to section 12 for the required checks to be carried out.

Ensure the product has been cleaned thoroughly in accordance with section 10 of this manual.

Ensure a copy of the user manual is supplied with the product. A copy can be downloaded from our website www.leckey.com.

Leckey recommend that a written record is maintained of all product inspections carried out during the reissue of the product.

If in any doubt to the continued safe use of your Leckey product or if any parts should fail, please cease using the product and contact our customer service department or your local dealer as soon as possible.

14 Product Servicing

Servicing of all Leckey products should only be carried out by technically competent persons who have been trained in the use of the product.

In the UK & ROI please contact the Leckey Service Centre on UK 0800 318265 or ROI 1800 626020 and our customer service department will be delighted to assist you with your servicing requirements.

17 Technical Information

Standard Product

(includes frame, pelvic support system, standard swivel seat, prone angle adjustment, quick release wheels and anti-tip bars)

- KW01 Size 1 Kidwalk – Candy Red with 20" wheels
- KW02 Size 2 Kidwalk – Candy Blue with 24" wheels

Seat Options

- KW06 Extended Seat 8" (Size 1)
- KW07 Extended Seat 6" (Size 1)
- KW08 Short Extended (Size 1)
- KW19 Additional Standard Seat (Size 1)
- KW22 Extended Seat 8" (Size 2)
- KW23 Extended Seat 6" (Size 2)
- KW24 Short Extended (Size 2)
- KW26 Additional Standard Seat (Size 2)

Frame Options

- KW04 Cruiser Wheels, pair (Size 1 only)

Wheel Options

- KW03 Anti Roll Back Device, pair
- KW17 20" Spoke wheels, pair (Size 1 only)
- KW16 Spoke protectors, pair

Upper Body Supports

- KW12 Lateral Chest System Size 1
(width 6.5"-10.5", depth 4"-6.5")
- KW13 Lateral Chest System Size 2
(width 8.5"-14.5", depth 5.5"-8.5")
- KW20 Upper Body Wrap

Headrest Options

- KW09 Headpad (does not include mount)
- KW11 Small contoured headrest
(does not include mount)
- KW12 Medium contoured headrest
(does not include mount)
- KW18 Square tube headrest mount

Positioning Options

- KW05 Extended Hip Laterals, pair
- KW14 Leg Straps, Pair (seat mounted)
- KW15 Leg Wraps, pair

Size	1		2	
Age (approx)	1 - 7		5 - 12	
Codes	KW01		KW02	
	mm	inches	mm	inches
Base Width	600	24	688	27.5
Base Height	675	27	800	30
Overall Length	825-875	33-35	900-950	36-38
Mast Height	825	33.5	930	37.25
Wheels	500	20	600	24
Castors	100	4	125	5
Seat Height	225-550	9-22	375-700	15-30
Max. User Weight	30kgs	65lbs	50kgs	110lbs

LECKEY^o

Leckey
19A Ballinderry Road
Lisburn BT28 2SA
Northern Ireland
United Kingdom

T: 028 9060 2277
F: 028 9060 0795
E: info@leckey.com
W: www.leckey.com

24 hour postural
care for babies,
kids & adults.
Sleeping, Sitting,
Standing, Walking,
Moving, Bathing,
Toileting.