

Grid 12

Manual

Created by

Smartbox

Smartbox

Grid Pad Manual (Version 1.1)
English (UK)

Copyright 2018 Smartbox Assistive Technology
thinksmartbox.com

Grid Pad 12

Welcome to Grid Pad, your complete communication
and access solution

Contents

1. Introducing Grid Pad	6
1.1 What is included with your Grid Pad	8
1.2 Grid Pad setup	9
1.3 Features	10
2. Quick start guide	14
2.1 Turning on your Grid Pad	16
2.2 Creating your user account	18
2.3 Choosing your grid sets	19
2.4 Introducing Grid Explorer	20
2.5 Configuring your access method	21
3. Using your Grid Pad	22
3.1 Your Grid Pad desktop	24
3.2 Power	26
3.3 The remote power button	28
3.4 Charging your Grid Pad	30
3.5 Mounting your Grid Pad	31
3.6 Audio and speech	34
3.7 Using headphones and audio feedback	36
3.8 Screen brightness	37
3.9 Using another screen with your Grid Pad	38
3.10 Internet and network settings	39
3.11 Bluetooth	40
4. Access	42
4.1 Switch access	44
4.2 Pointer access	47
4.3 Touch access	48
4.4 Keyboard and mouse access	49
4.5 Voice activation and access	50

4.6	Eye gaze	51
5.	Environment Control	60
5.1	Introduction to Environment Control	62
5.2	Transmitters	63
5.3	Servus Environment Control grid sets	64
5.4	Infrared controls	65
5.5	Setting up a radio device	69
5.6	Connecting a phone to your Grid Pad	72
6.	Grid 3	74
6.1	Introducing Grid 3	76
6.2	Adding grid sets	77
6.3	Useful commands to control your Grid Pad from Grid 3	80
6.4	Grid 3 accounts	81
7.	Looking after your Grid Pad	82
7.1	Software updates	84
7.2	Getting the most out of your battery	86
7.3	Cleaning and storing your Grid Pad	88
8.	Appendices	90
8.1	Smartbox support	92
8.2	Grid Pad specification	94
8.3	Device specification	96
8.4	Symbol explanation	97
8.5	Safety notices	98
8.6	Statement of compliance	105
8.7	Battery warnings	109

In this section

- 1.1 What is included with your Grid Pad
- 1.2 Grid Pad setup
- 1.3 Features



Introducing Grid Pad

1.1

What is included with your Grid Pad

- Grid pad communication aid
- Remote power button
- Manual
- Mounting plate and screwdriver
- Power lead
- Grid 3 training pack
- Cleaning cloth
- 2x AAA batteries
- Optional port labels

Your Grid Pad may also be supplied with an eye gaze unit.

Included Software

Grid 3

If supplied with eye gaze, additional drivers and software will be pre-installed.

Grid Pad setup



Your Grid Pad can be supplied in one of two ways.

Communication only

This is sometimes known as kiosk mode. In this setup, the Grid Pad will boot directly into Grid 3 and can be used for communication. Certain features, such as accessible apps and Windows desktop are switched off.

Unlocked

When unlocked the Grid Pad gives you full access to the accessible apps as well as Windows desktop and applications.

Changing your set up

If you would like to change the way your Grid Pad has been set up, please contact your Grid Pad supplier.

1.3

Features

Grid Pad

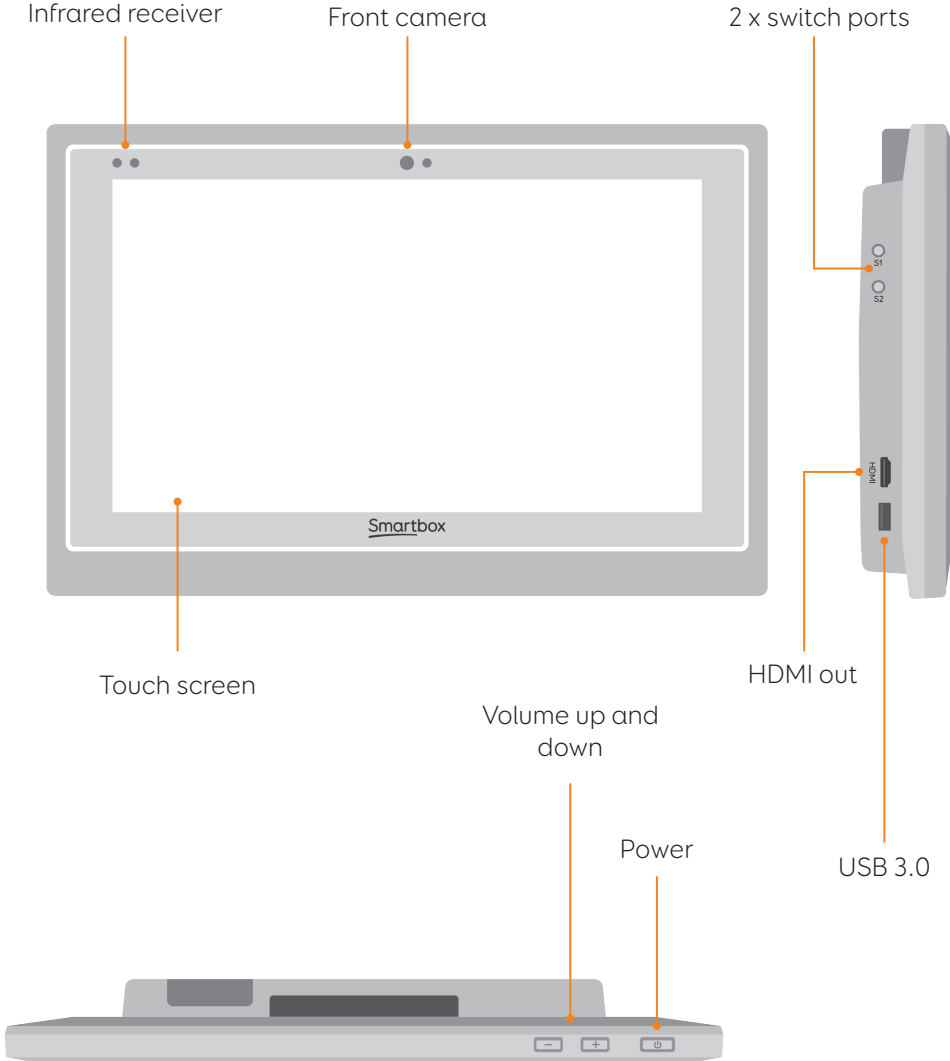

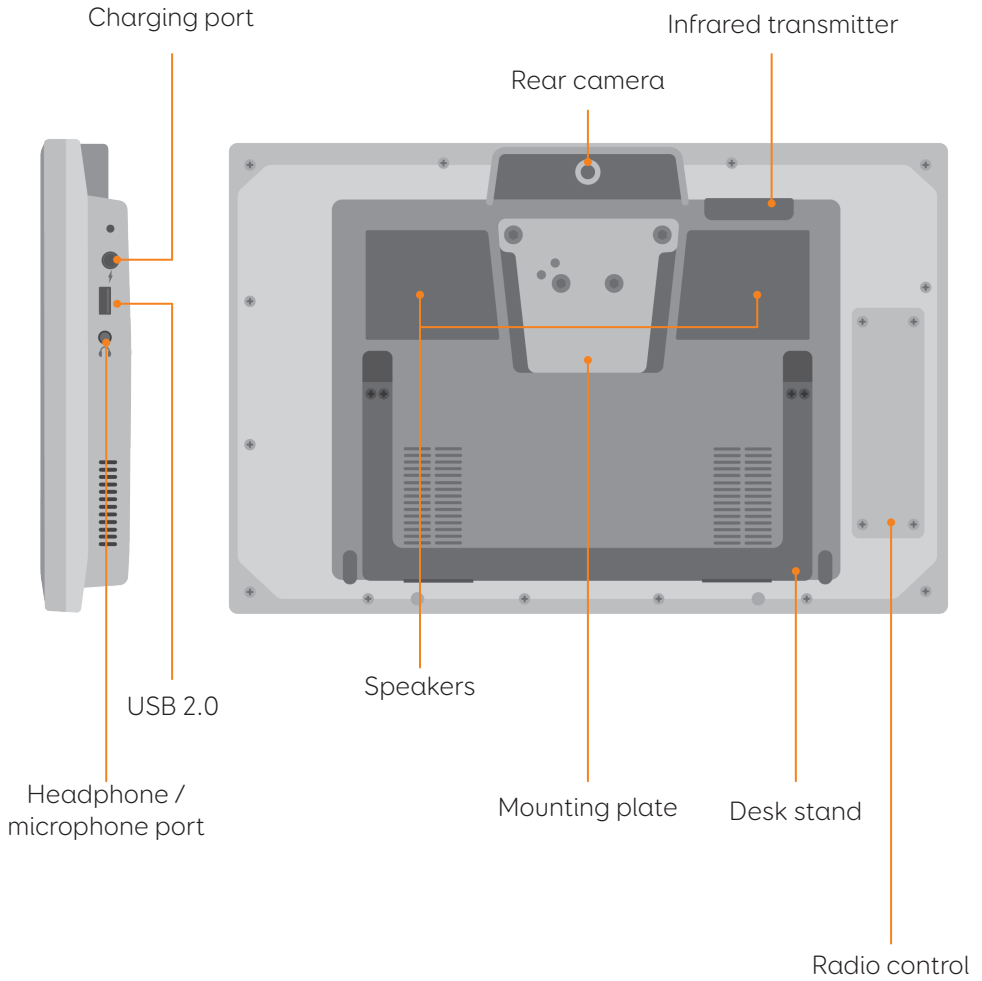

Grid Pad with eye gaze unit

When the Grid Pad is supplied with an eye gaze unit, it comes with a longer desk stand to accommodate the camera.

The USB 3.0 socket will be used for the camera connection.

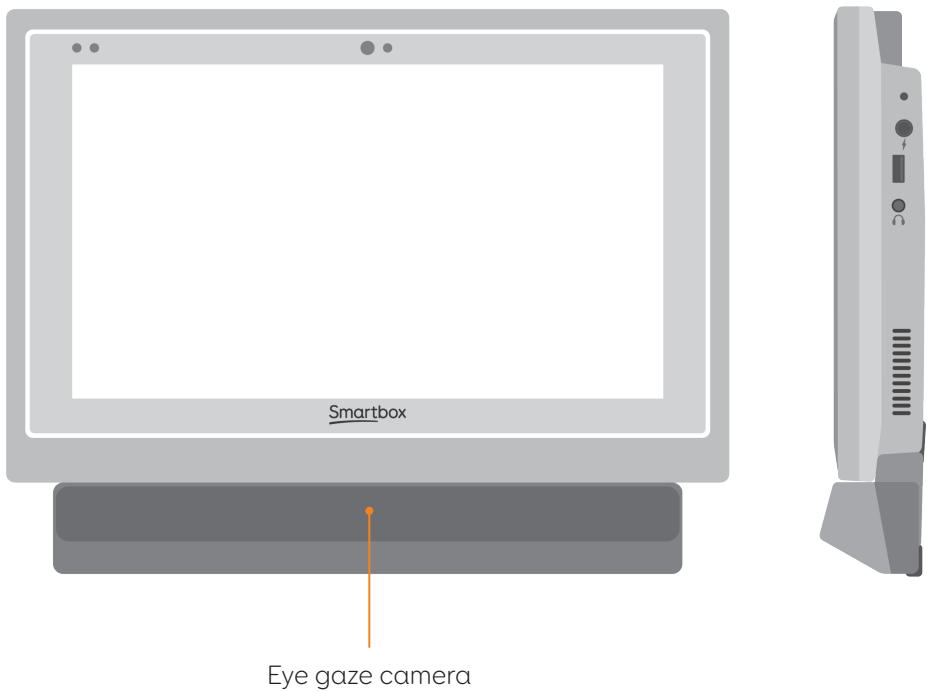

For more information on attaching and removing the eye gaze unit see section 4.6.

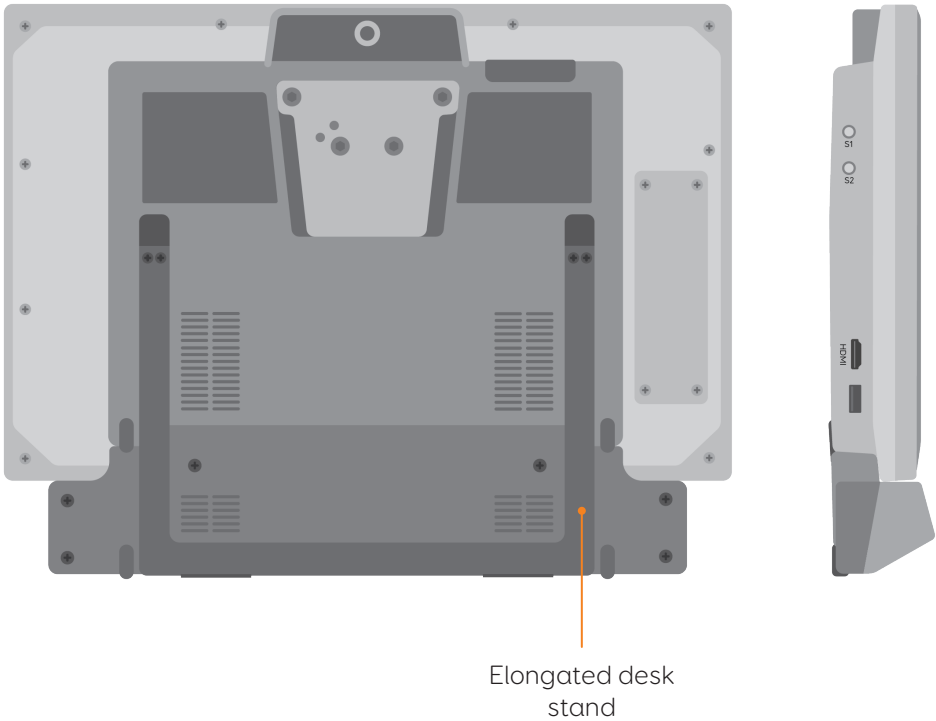

In this section

- 2.1 Turning on your Grid Pad
- 2.2 Creating your user account
- 2.3 Choosing your grid sets
- 2.4 Introducing Grid Explorer
- 2.5 Configuring your access method



Quick start guide

2.1

Turning on your Grid Pad

Before switching on your Grid Pad for the first time, it is best to plug in the power lead and charge the battery. Press the power to turn the device on, the LED will light up to signal the device is starting.



The device will boot into Windows, and Grid 3 will automatically start.

Creating your user account

2.2

Once Grid 3 has loaded, tap Get Started to create your account and then follow the instructions on the screen.

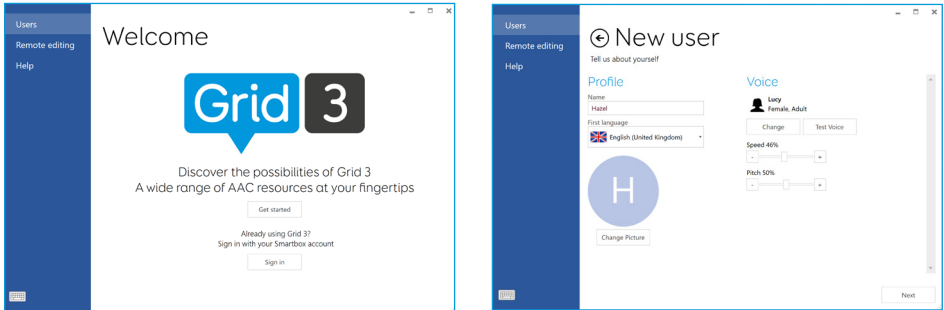

Grid 3 comes with a selection of voices for you to choose from. You can adjust the speed and pitch of each voice to suit your needs.

Your Smartbox Account

On the next screen you can create a Smartbox Account. This enables you to use features such as remote editing and syncing between devices.

Tip: If you already have a Smartbox account you can log in and restore your account.

2.3

Choosing your grid sets

A grid set is like an app within Grid 3. Some grid sets may contain a complete symbol vocabulary for starting out with communication. Others may be designed for literate users to communicate as efficiently as possible.

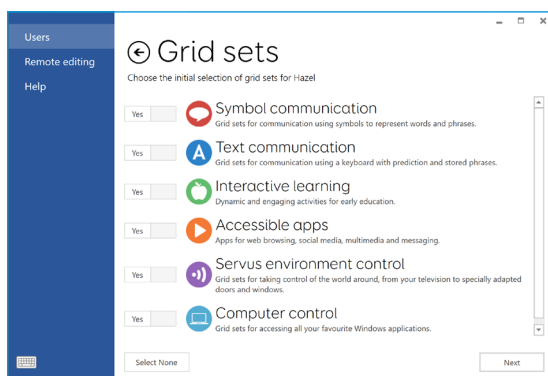

Grid sets are organised into categories. Choose Symbol communication for grid sets like Super Core, which are ideal for early AAC users and emerging literacy. Choose Text communication for grid sets with powerful features for literate users.

Grid sets from each category you select are added to your Grid Explorer, ready for you to explore.

Tip: With your permission Grid 3 can learn the words you use most often to improve your prediction suggestions. You can change this in your Privacy settings at any time.

Introducing Grid Explorer

Grid Explorer is your Grid 3 home screen. From here you can browse and arrange your grid sets, add new grid sets and access your settings.

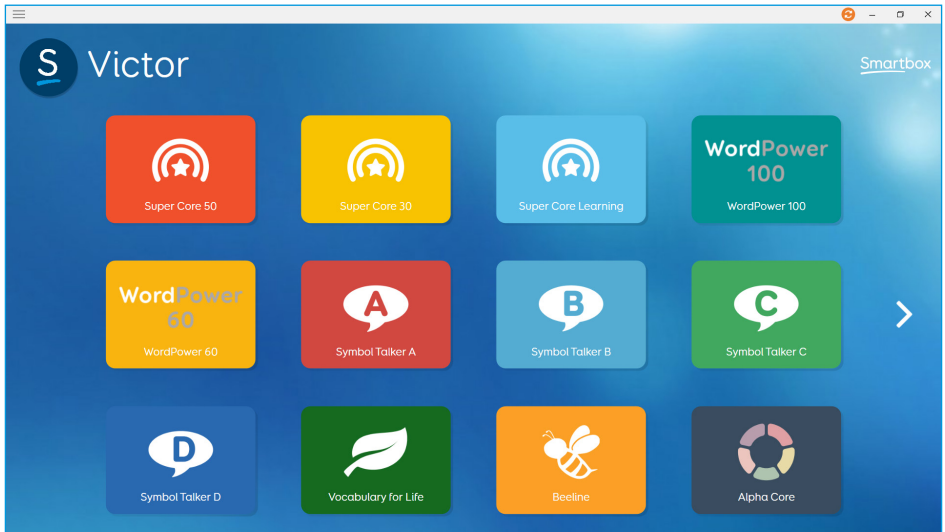

Tapping on a grid set will open it.

To return to Grid Explorer, tap the menu then select Grid Explorer.

2.5

Configuring your access method

You will need to choose the way you want to access your Grid Pad. There are multiple access methods available to you. See the relevant sections of this manual for more information on setting up your chosen access method.

- Touch access
- Switch access
- Pointer access
- Voice access
- Eye gaze access

You will need the suitable hardware to configure your chosen access method.

Tip: Remember you can use multiple access methods together. Both Grid 3 and your Grid Pad are designed to be flexible. If you want to use a head pointer with a switch to activate, you can!

In this section

- 3.1 Your Grid Pad desktop
- 3.2 Power
- 3.3 The remote power button
- 3.4 Charging your Grid Pad
- 3.5 Mounting your Grid Pad
- 3.6 Audio and speech
- 3.7 Using headphones and audio feedback
- 3.8 Screen brightness
- 3.9 Using another screen with your Grid Pad
- 3.10 Internet and network settings
- 3.11 Bluetooth



Using your Grid Pad

3.1

Your Grid Pad desktop

Grid Explorer



Windows desktop

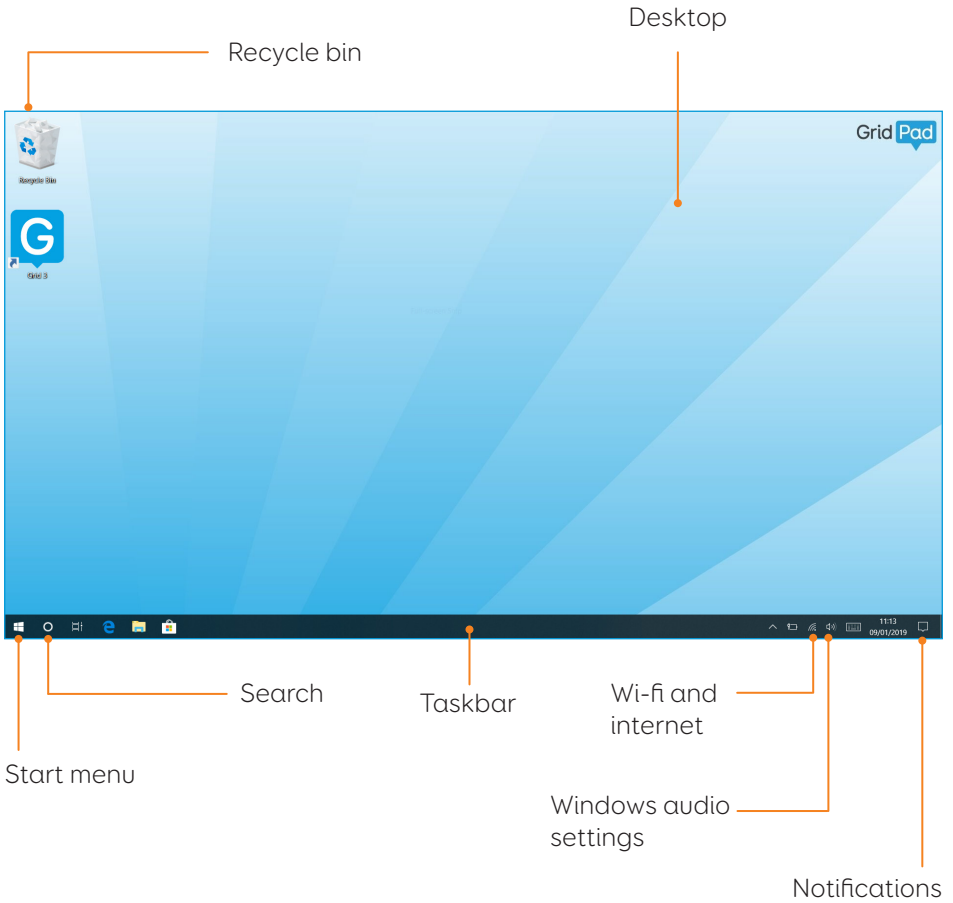

3.2

Power

The power button is located on the top right of your Grid Pad. Press the button to switch it on. Your device will boot or wake from sleep.

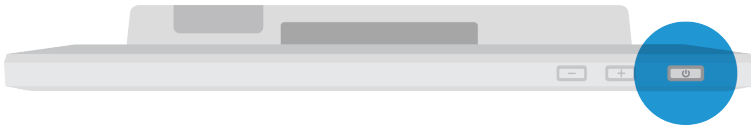

Shutting down your Grid Pad

When not in use, it is good practice to shut down your Grid Pad completely. This will give any automatic updates a chance to be applied. We also recommend that your device is shut down before it is stored for transit.

Open the Start menu and tap the power icon. From here you can select Sleep, Shut down and Restart. Selecting Shut down will power the device down completely.

It is also possible to turn off your device from within Grid 3, by using the Turn off computer command. This command can be added to any grid set. (See the section 6.3 of this manual for more information about these commands).

Force shut down

If you press and hold the power button for five seconds, your Grid Pad will shut down. Please note that this is only recommended in emergencies, and that any unsaved work will be lost.

3.3

The remote power button

Your Grid Pad comes supplied with a remote power button. This is designed to enable anyone to turn on their device either using the built in button or a separate switch.

Setup

The remote power button will already be paired with your Grid Pad. To use the remote power button, remove the battery cover on the back and insert two AAA batteries. If you do not intend on using the remote power button, or need to store it for a long period, we recommend that you remove the batteries.

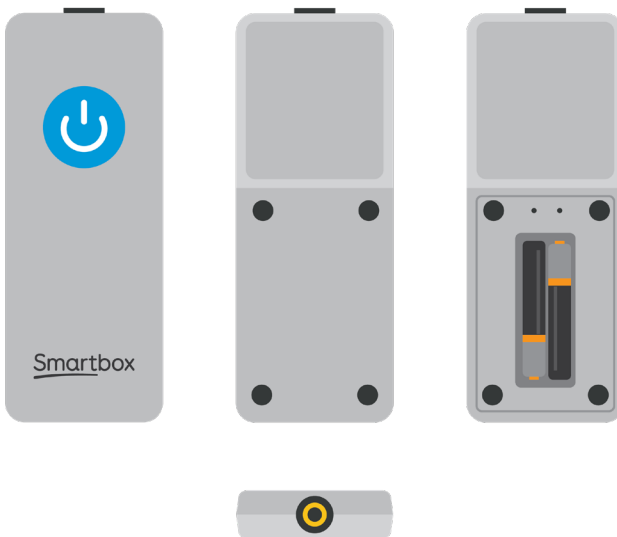

Using the remote power button

Press the power button once to turn your Grid Pad on or wake it from sleep.

Press and hold the button for 5 seconds to force the Grid Pad to shut down. Note you may lose work and unsaved changes!

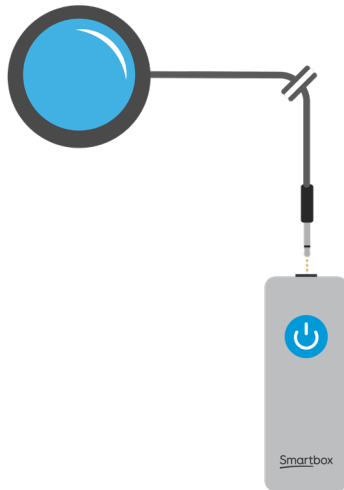

Attaching an additional switch

The remote power button has a built in 3.5mm jack. You can use this to attach a compatible switch to turn your Grid Pad on. When a switch is attached, it will act exactly like the button.

Note: The remote power button is only designed to turn the Grid Pad on or wake your device from sleep, it cannot be used to access Grid 3.

3.4

Charging your Grid Pad

To charge your Grid Pad, plug the power lead into the charging port on the left side of the device.

A full charge will take up to 8 hours. See section 7.2 for more information on looking after your battery.

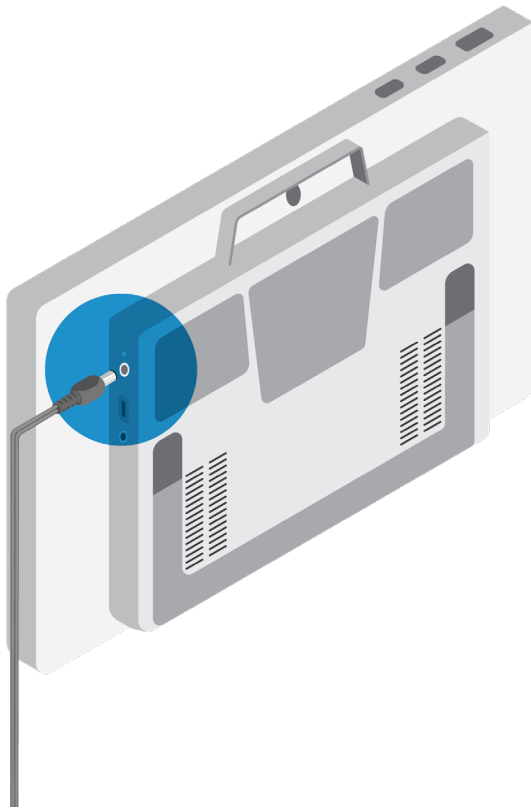

Mounting your Grid Pad

Adjustable stand

Your Grid Pad has an adjustable stand that can be folded out, to position your device on a desk or table comfortably.

Pull the stand from the bottom and adjust the angle to suit you. When finished, simply push the stand back in.



Using a desk, floor, or wheelchair mount

Your Grid Pad is supplied with a combined Daessy and Rehadapt mounting plate, so that you can securely mount and position your device.



Dual mounting plate

Removing the mounting plate

To remove the mounting plate, lay your Grid Pad with the screen facing down on a flat surface. To prevent damage to the screen, place the device on something soft like a towel, cloth or newspaper. Use the supplied screwdriver to remove the four screws that secure the mounting plate to your Grid Pad.

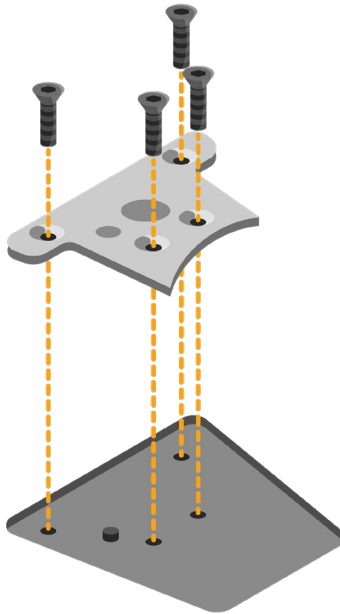

Mounting your Grid Pad on a desk or floor stand

With the correct mounting plate attached, you can fit the Grid Pad to your wheelchair mount, floor stand or desk stand. As you attach the device to the stand, be sure to hold the Grid Pad securely until the head of the stand is firmly docked with the mounting plate.

For further instructions on positioning see the documentation provided with your stand.

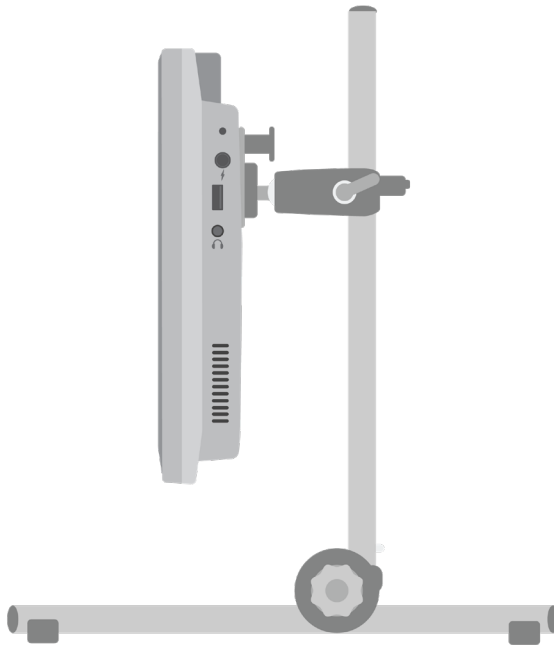

3.6

Audio and speech

Your Grid Pad has two main speakers, designed to make your sure your voice can be heard in any environment.

The device also has a headphone port, which can be used for personal audio. This is called audio feedback and can help you navigate Grid 3 by reading out labels, words, and actions while you communicate.

The audio settings in Grid 3 are found under **Settings - Speech**.

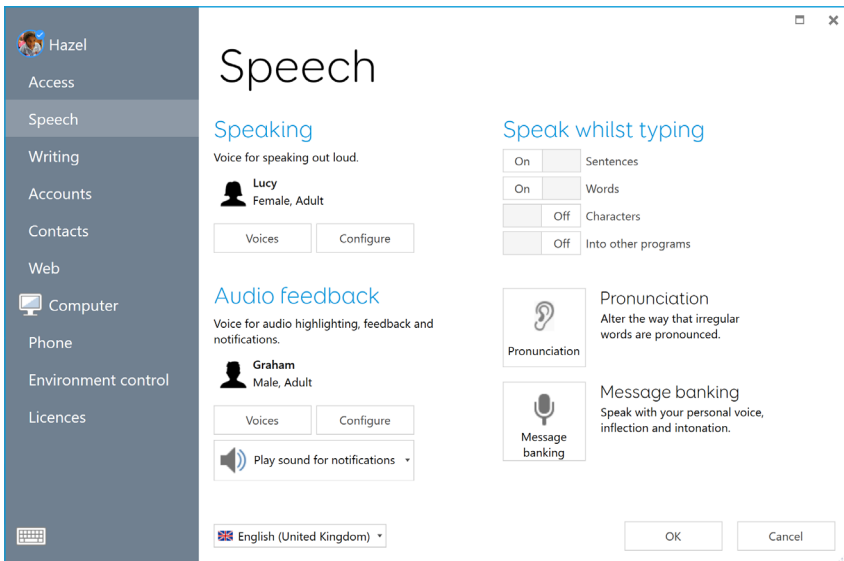

Speaking

Under Speaking you will find settings for the to the voice projected from your Grid Pad.

Here you can choose from a selection of voices that are included

with Grid 3, or available to download.

You can also adjust the pitch, speed, and volume of your voice.

Audio feedback

Under Audio feedback you can choose and adjust the voice that Grid 3 will use for audio highlights, reading out labels and giving notifications. This can be completely different from your speaking voice to help differentiate between spoken and personal audio.

Windows audio settings

The Windows audio settings are found in your Windows taskbar in the bottom right corner of your screen in the taskbar. You can get to these settings by right clicking, or pressing and holding the Speaker icon.

Here you can access the volume mixer, playback devices, recording devices and sounds. If you are having issues hearing your audio, it is good to check you haven't muted one of the sound channels.

3.7

Using headphones and audio feedback

To use headphones with your Grid Pad without disrupting your speaking voice, connect your headphones to the headphone port.

Head to **Settings - Speech** and tap **Configure** under Audio feedback. Then select Grid Pad headphones from the drop-down menu under Speakers.

Sending media audio through headphones

To listen to media such as music and videos privately, attach your headphones as normal and tap the Speaker icon in your Windows taskbar. Then select your headphones.

Tip: You can also use Bluetooth headphones or headsets with your Grid Pad. Once connected, these will be listed when you tap Configure under the Speakers heading.

Screen brightness

3.8

The Grid Pad has a full HD screen that supports a range of brightness levels, so it is easy to find a setting that suits you. The brightness of the screen can be adjusted both within Grid 3 and through your Windows settings.

Brightness command in Grid 3

When using Grid 3, you can adjust the brightness of the screen using the Brightness command. You can add this command to your grid sets in edit mode, when you create a cell. These cells can be set to cycle the brightness, increase or decrease the brightness of the screen, or set the brightness to a specific value.



Tip: Using these commands you could create a cell that sets your Grid Pad to 'night mode' or a low brightness when you are watching TV or a movie.

Windows display settings

Open the Start menu and tap the settings cog. The Windows display settings are found under **Settings - System - Display**. From here you can change the brightness, and adjust the size of Windows icons and menus.

3.9

Using another screen with your Grid Pad

The HDMI socket enables you to connect your Grid Pad to a second screen, or even a projector. When you attach the device to a second screen, the default setting will mirror the screen of your Grid Pad. To adjust these settings in Windows, open the settings cog from the Start menu and go to **Settings - System - Display**, then scroll down to Multiple displays.

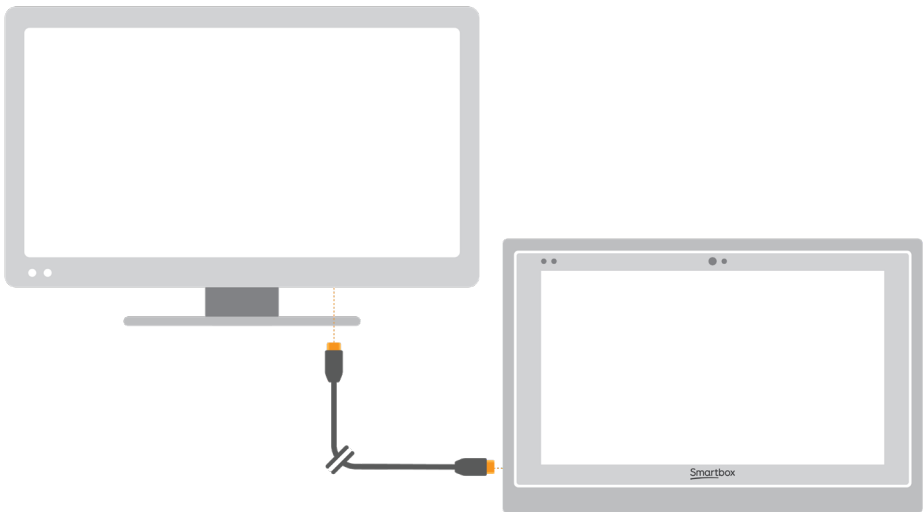

Here you can change the resolution for your Grid Pad and second screen, and choose to Extend your display. When this is selected, your desktop will cover both screens and enable you to multi-task. Note that certain access methods such as eye gaze are not compatible with extended displays.

Tip: If you are using a second screen, the additional processing required can have an impact on your device's battery life.

Wi-Fi

Your Grid Pad connects to the internet using Wi-Fi. This is accessible from your Windows taskbar. Tap the Wi-Fi icon to bring up the list of nearby wireless networks. Select your network and enter the network password if applicable. You can also choose whether you want your device to remember this connection.

Tip: Windows has numerous privacy settings surrounding your internet connection. Be aware of what is visible to other network users, particularly if you are using a public connection.

Network settings

To view further Network settings, open the settings cog from the Start menu and go to **Settings - Network & Internet**. Here you can view the status of your internet connection, configure how the Wi-Fi connects to public and open networks, set up a VPN connection and more.

3.11

Bluetooth

You can connect many types of Bluetooth device to your Grid Pad – from headphones and headsets to smart phones, printers, and access methods.

Bluetooth is switched off by default. Open the settings cog from the Start menu and go to **Settings - Devices** to turn on Windows Bluetooth features. Move the tab to On and your Grid Pad will start scanning for nearby Bluetooth devices.

You may need to type in a pairing code, depending on the Bluetooth device you are trying to pair. Refer to the device's instructions for more information on how to pair.

Tip: Be aware that even when not in use, having Bluetooth switched on can have an impact on the battery life of your Grid Pad.

In this section

- 4.1 Switch access
- 4.2 Pointer access
- 4.3 Touch access
- 4.4 Keyboard and mouse access
- 4.5 Voice activation and access
- 4.6 Eye gaze



Access

4.1

Switch access

Grid Pad has two 3.5mm sockets that you can use to connect a variety of switches to your Grid Pad. There are different options available to customise how you navigate Grid 3, using one or two switches.

Connection

To connect a switch to your Grid Pad, plug its 3.5mm jack into one of the switch sockets on your Grid Pad. (These are labelled S1 and S2 respectively).

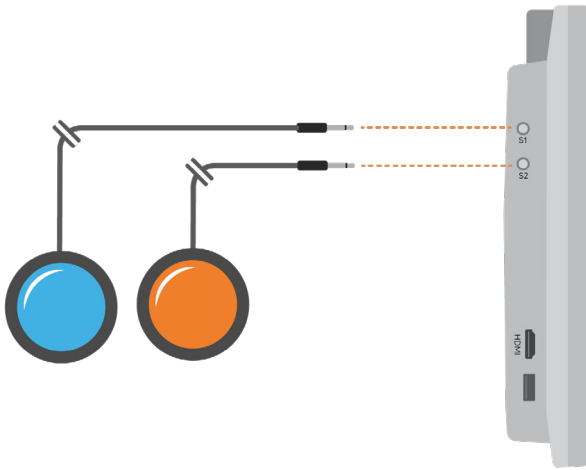

Once connected, open Grid 3 and go to **Settings - Access - Switches**. Selecting **Connection** under Configuration will display a list of potential switches. Activate your switch and it will highlight in green.

Tip: You can connect additional switch adapters via USB if you need more switches.

Bluetooth switches

To connect a Bluetooth switch to your Grid Pad, follow the pairing instructions provided with your switch. Make sure you have Bluetooth enabled on your Grid Pad. You can then configure the switch as normal.

Switch options

Activation

When your switches are connected to your Grid Pad, you can decide how they act within Grid 3. You can choose between Switch Scanning, Switch elimination and Switch joystick.

Open **Settings - Access - Switches** and select the method you would like to use from the drop-down box. Tap **Activation** to configure your chosen method.

Switch scanning

Switch scanning highlights groups of cells in turn to locate the cell that you want. This method highlights and scans through the cells in your grid in a linear fashion.

You can choose to start with rows or columns. Activate your switch to select the row or column you want, and then scan through that row or column until you reach the desired cell. Activating your switch again will then select that cell.

You can adjust the direction of scanning, the speed, and the way you want to activate cells. You can also configure highlighting options and how scanning will work with multiple switches.

Switch elimination

Switch elimination splits your grid into groups of cells, using two or four switches. This method focuses in on a group of cells every time you activate a switch, until you reach the cell you want. You can decide the elimination method, number of switches, highlighting colours and more. There are further options that enable additional switches to stop the elimination or go back a level.

Switch joystick

Switch joystick enables you to use a joystick game controller (connected via USB or Bluetooth) or a set of switches to select the cells in your grid. Navigate around a grid set freely and activate an additional switch to select the cells you desire. You can personalise highlighting, movement, and activation options.

Switch commands

Switch commands enable you to trigger specific Grid 3 actions with your switches. Tap the **Commands** button and select one of your switches from the Add switch window. Then assign a command for your switch to trigger when activated. This could be putting the device to sleep, saying a particular phrase, or triggering an Environment Control option.

Pointer access

Grid 3 supports many pointing devices. These access methods let you guide the mouse cursor and interact with your Grid Pad.

Follow the instructions provided with your pointing device to connect it to your Grid Pad. You may need to install additional drivers and software for the device to work correctly.

Pointer settings are found in Grid 3 under **Settings - Access - Pointer**. You can choose how the cursor will activate cells, either with a click, hold, dwell, or using an additional switch.

You can also choose how you access your device using Computer Control such as Zoom to move and Click.

4.3

Touch access

The screen of your Grid Pad is fully touch accessible. You can access the touch screen settings in Grid 3 under **Settings - Access - Touch**. Here you select your highlighting preferences and can choose how you want to activate cells in Grid 3.

Activate last item touched means that the last place you touch the screen is the part that will be selected.

Activate first item touched takes the first location touch and activates once the screen is released.

Touch and hold to activate gives you an adjustable length of time to press and hold your selection before it activates.

Using your touch screen as a switch

Your entire touch screen can act as a switch using Grid 3. To set this up go to **Settings - Access - Switches** and select the Connection under the Configuration heading. Use the drop-down menu to select Touch screen.

You can configure your touch screen presses in the same manner as Switch access.

Using a keyguard

Your Grid Pad supports keyguards to help you make more accurate selections. Keyguards are usually custom made to fit your grid sets. (See the instructions provided with your keyguard, to mount it to your Grid Pad).

Keyboard and mouse

You can connect a keyboard and mouse to your Grid Pad using either the USB ports or via Bluetooth. To use a wired device, simply plug it in to one of the USB ports found on the side of the Grid Pad. USB keyboards and mice will automatically be detected in Windows.

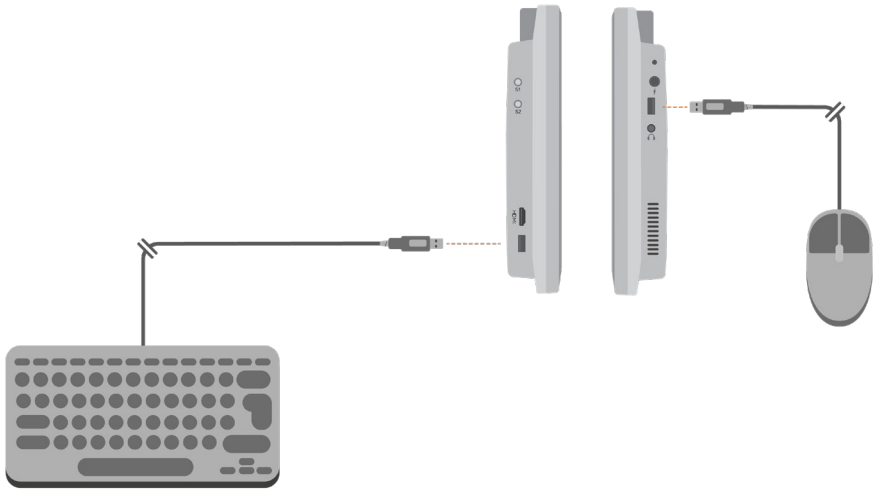

To connect a Bluetooth keyboard or mouse, make sure that Bluetooth is switched on and follow the pairing instructions provided with your keyboard or mouse.

4.5

Voice activation and access

You can use your voice to access Grid 3. This requires an additional microphone or headset to be connected to your Grid Pad. We recommend a USB or Bluetooth microphone or headset.

Once configured, voice commands are activated by speaking the wake-up phrase “Hey Grid 3...” followed by the text on the cell you desire.

Configuring voice access

The settings to configure voice access are found in **Settings - Access - Voice**. From this screen you can select the microphone you wish to use by tapping the **Audio input** under Microphone. Once you have selected your microphone we recommend that you use the Configure tool, followed by **Improve accuracy** to read out several test sentences.

You can set the “Hey Grid 3...” wake-up phrase to anything you like, and adjust the length of time you need to issue your commands once the wake-up phrase has been activated.

You can also choose to have a sound after the wake-up phrase has been activated, and once your selection has been made.

The Grid Pad camera unit

Your Grid Pad can support eye gaze access. Attach the camera unit to your Grid Pad to access the device with a range of cameras.

Tip: There is also a range of mounting plates for many eye gaze cameras. Contact Smartbox for more information.

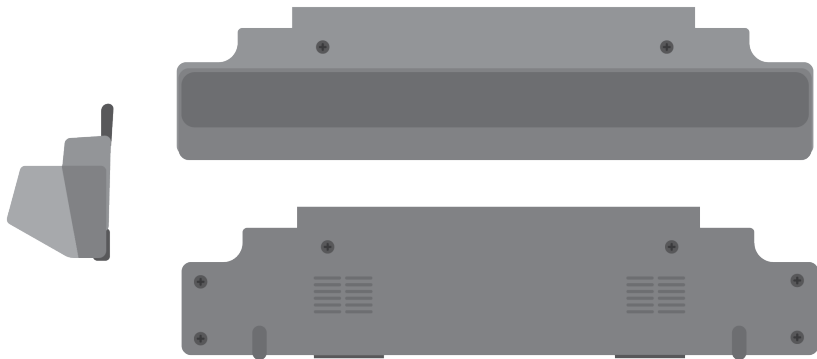

Attaching the Grid Pad camera unit

The camera module attaches to the bottom of your Grid Pad. Place the Grid Pad face down on a flat surface, and remove the desk stand. Use the provided screwdriver to remove the four screws.

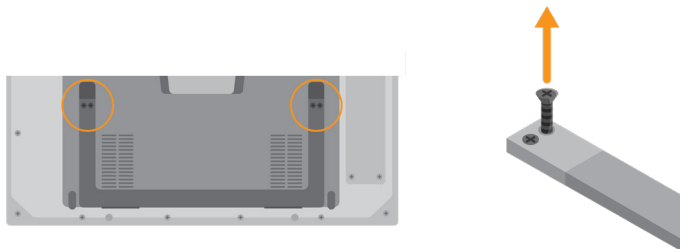

Position the Grid Pad camera unit to align the screw holes with the holes on the underside of your Grid Pad.

Attach the Grid Pad camera unit with the two provided screws, and tighten with the included screwdriver, making sure they are firmly fixed.

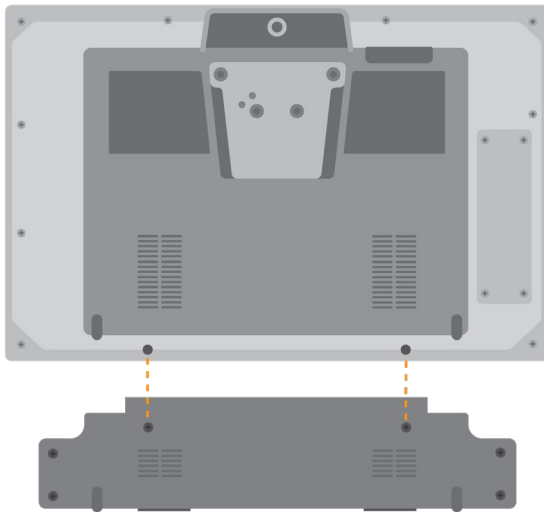

Plug the camera's USB connection into the USB 3.0 port on the right side of the Grid Pad. Do not use a USB hub or an extender cable as this may cause the camera to perform poorly.

Place the longer eye gaze stand where the Grid Pad stand used to be and use the four screws to firmly fix the stand to the Grid Pad.

Depending on the camera that is inside the camera unit, you may need to install the appropriate software.

Setting up your Grid Pad for eye gaze access

It is important to have your Grid Pad set up securely for eye gaze access. Position the device between 40cm and 75cm from your eyes, using either the built-in stand or mounted on a stand that suits you. The best position may vary depending on the camera you are using. (See the section Mounting your Grid Pad section of this manual for more information on mounting options).

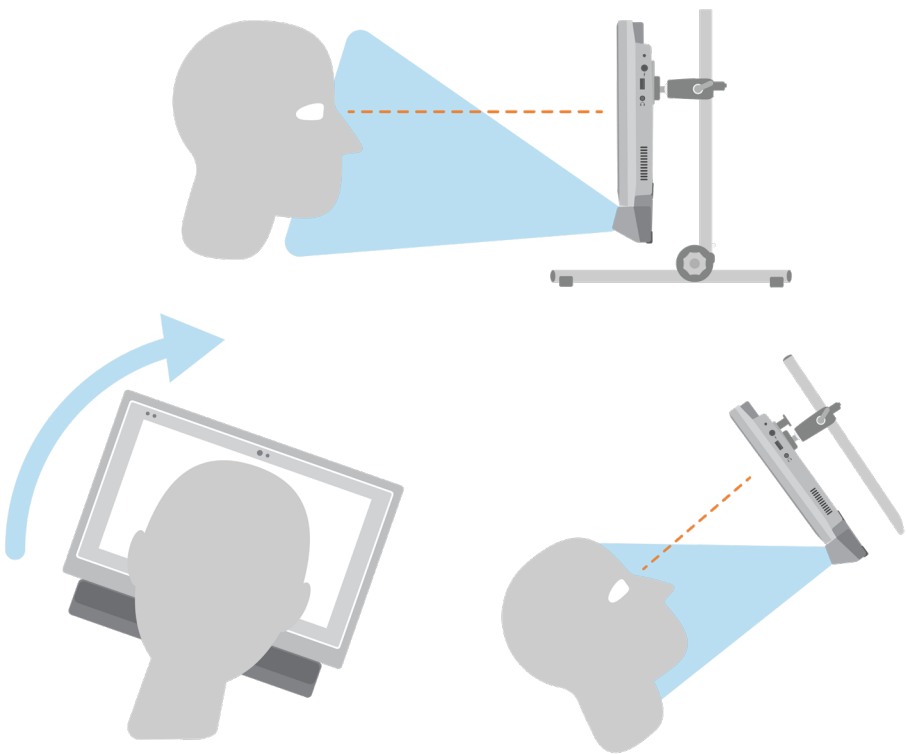

Different eye gaze cameras have their own optimal distance. Ideally the camera should be placed so it is between 50cm and 70cm from your eyes.



Use the Grid 3 eye gaze monitor window to help you find the right distance and angle. This is found in **Settings - Access - Eye Gaze**. Some cameras have a live view option, which will give you a video feed from the camera.

Calibration

Calibrating the eye gaze camera helps it focus on how your eyes move around the screen. During a calibration you will be asked to follow targets around the screen, and the camera will score how accurate you are in holding your gaze in each location.

In Grid 3 open **Settings - Access** and select **Eye gaze**. Use the drop-down menu to select your camera. Choose **Settings** to bring up the Calibration options.

Using the Calibration options, you can select how your target will look, the colour of the background, and the number of points to calibrate. You can also choose between continuous or a stepped calibration that enables you to tap the screen to progress between points.

Tap the **Calibrate** button to begin. You can cancel your calibration by clicking the cross in the top right. Once complete you will be given your calibration results. The camera will remember your calibration, so you do not need to calibrate every time you use your device. Recalibrating is recommended if there is a change in environment or positioning.

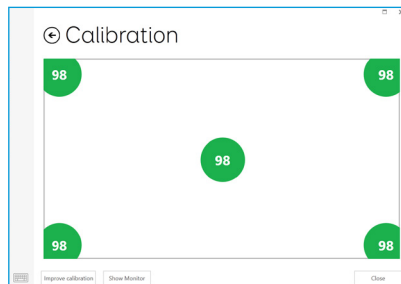

Improving your calibration

Once you have completed your first calibration, you can use the Improve calibration option to focus on any problem areas. This is a good opportunity to check the position of the device, and your surroundings for any potential interference such as reflections or strong daylight.

Calibrating from a grid set

You can start a calibration directly from a grid set with the Calibration command. Some grid sets have this option already in the Settings grid. You can also use the Improve calibration command to focus on any difficult areas.

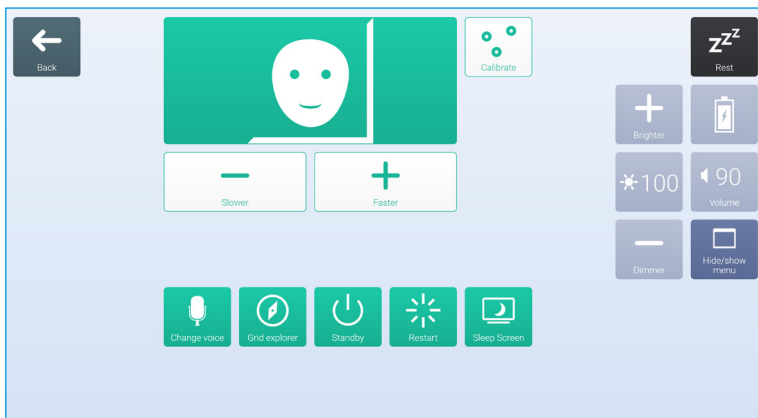

Configuring your eye gaze options

In Grid 3 you can customise how you want your eye gaze access to behave. There are camera specific options listed under

the Camera. This can include smoothing, which evens out the camera's response and make moving around the screen easier in some cases.

Certain cameras support tracking one or both eyes. This can be useful if tracking both eyes causes issues.

Under Activate you can decide how you want to select cells. You can choose from dwelling, blinking or pressing a to click.

Dwell to Click

Dwell to click activates a cell after you have rested your gaze on it for a set time. You can choose how the speed of the dwell and how you want it to appear. You can also filter out repeat activations.

Blink to click

Blink to click allows you to highlight cells with your gaze and select them with a blink of a set duration. Minimum and maximum blink times can be set to filter out regular blinks.

Press switch to click

Press switch to click allows you to attach an additional switch to your Grid Pad to activate a cell that has been highlighted with your gaze. You will need to set up your switch connection under **Settings - Access - Switch**.

Highlighting

You can select the options around the highlighting of cells with eye gaze. You can also choose to show a dot that represents how your gaze appear on the screen.

Computer control

Under Computer control you can specify how you would like to interact with Windows.

Move pointer, no click

Move mouse pointer simply enables you to guide the mouse cursor around the screen without clicks.

Move pointer, switch to click

With Press switch to click you use the eye gaze camera to move the pointer around the screen and press your switch to make a selection. You will need to have connected a switch to your grid pad and configured it in **Settings - Access - Switch**.

Move pointer, blink to click

Blink to click uses the eye gaze camera to move the pointer around the screen and blinks to make your selections. You can adjust the minimum and maximum blink times to prevent accidental activations.

Move pointer, dwell to click

Move the mouse pointer around the screen with your gaze and a dwell will begin when still.

Dwell to move and click

Dwell to click lets you move the mouse around the screen with your gaze. When still, the dwell timer will appear. With this option you will not see the mouse pointer on the screen.

Zoom to move and click

Zoom to click enables you to focus in on a part of the screen with a slow zoom, so you can pinpoint exactly where you want to interact with the screen. You can adjust the speed and level of magnification.

Use your eye gaze system's mouse control

Some eye gaze cameras have their own software with Computer control options. You can use this software instead of Grid 3's Computer control options.

Other eye gaze cameras

If you want to use the Grid Pad with a camera you already own, mounting plates are available for a range of popular devices. Refer to your local dealer and supplied instructions to mount alternative cameras.

In this section

- 5.1 Introduction to Environment Control
- 5.2 Transmitters
- 5.3 Servus Environment Control grid sets
- 5.4 Infrared controls
- 5.5 Setting up a radio device
- 5.6 Connecting a phone to your Grid Pad



5

Environment control

5.1

Introduction to Environment Control

Your Grid Pad can control a range of devices to give you more independence. With infrared technology your Grid Pad can learn to control your TV, set-top boxes, or other devices around your home. Your Grid Pad also includes a radio transmitter that can be used to control lights, doors, windows and more.

Environment Control settings are found in Grid 3 under **Settings - Environment control**.

Transmitters

Your Grid Pad has two built-in transmitters. A GEWA infrared transmitter and a radio control transmitter can be found on the rear of the device.

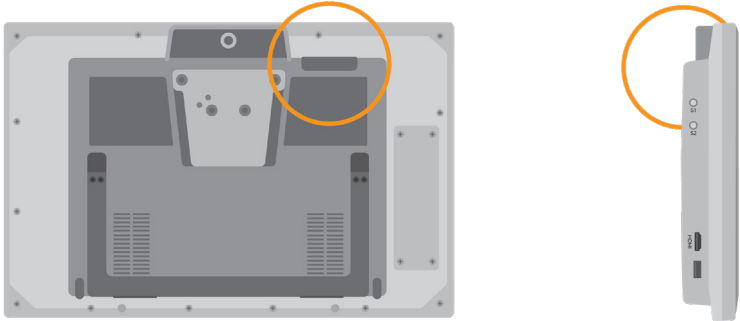

The infrared transmitter and its broadcast angle

Changing the radio transmitter

Your Grid Pad is supplied with either an EasyWave or Z-Wave transmitter. If you need to swap the transmitter, you can access the port by unscrewing the panel on the back of your device.

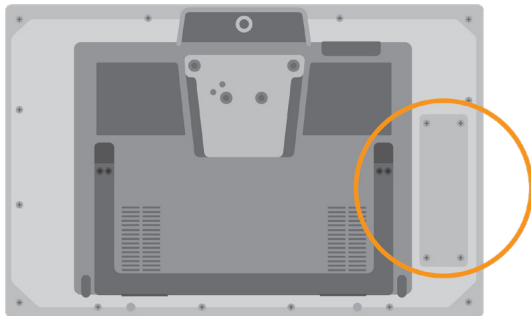

Disconnect the installed transmitter and replace it with your chosen transmitter. You may also need to install the appropriate drivers for your transmitter.

5.3

Servus Environment Control grid sets

Grid 3 comes with two ready-made grid sets for Environment Control: Servus Environment Control and Simple Servus Environment Control.

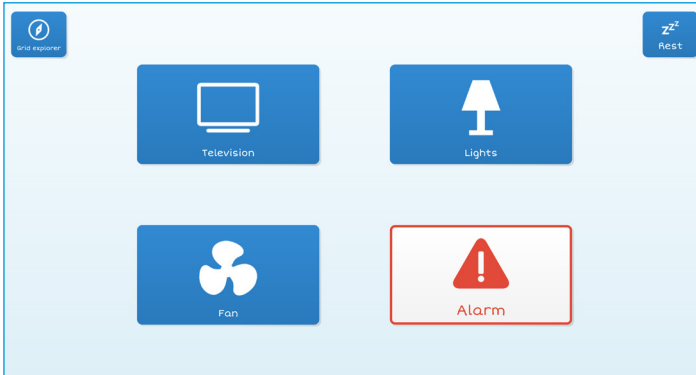

Simple Servus environment

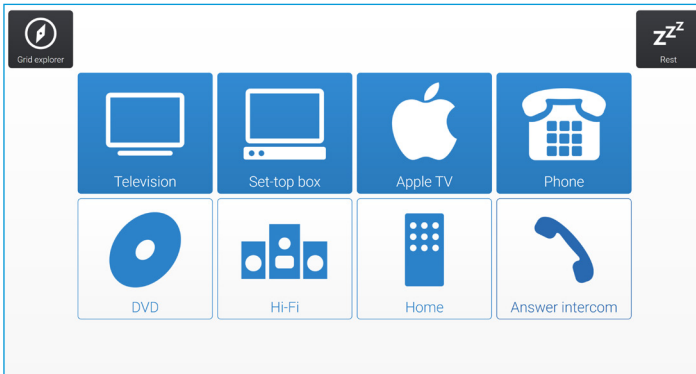

Servus environment control

Tip: More Environment Control resources are available through Online Grids. Try using voice activated devices such as Amazon Alexa to control your home.

Infrared controls

5.4

Setting up an infrared remote

The Servus Environment Control grid sets are ready for variety of devices and appliances. You will need to teach your Grid Pad the correct infrared codes.

Using Infrared remote files

We keep a list of different IR remote codes for many home entertainment devices. Before you start setting up your devices, check the list to see if we have the relevant codes pre-programmed to save you time. These files are stored as .remote files. To find our current list of remotes visit:

thinksmartbox.com/ir-remotes

Installing a remote file

To install a .remote file, download the file you need from our website, close down Grid 3 and open your File Explorer.

Navigate to: **Users\Public\Documents\Smartbox\Grid 3\Environment Control Accessories**

Copy the .remote file into this folder and open Grid 3.

In Grid 3 Go to **Settings – Environment control** and you will now see the new device listed.

Setting up an infrared remote manually

To set up a remote manually, open Grid 3 and go to **Settings - Environment control**. Under Accessories select **Add**.



You will see a list of accessories. Select the type you would like to configure, and you will be taken to the learning screen.

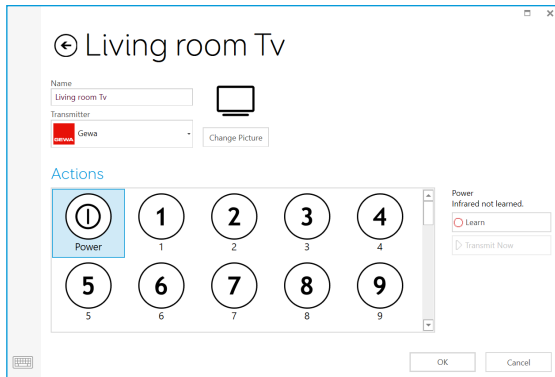

Here you can name your device (useful if you will be using more than one of the same type), change the icon and most importantly, learn the actions.

Select the action you wish to learn, for example Power, then tap the Learn button on the right side of the window.

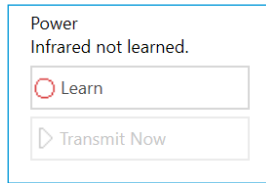

The Learn infrared window will appear and you will be asked to follow the instructions on the screen.

Remember to point your remote directly at the front of your Grid Pad. You will see the red receiver LED in the top left. When the IR code is received, this LED will blink once.

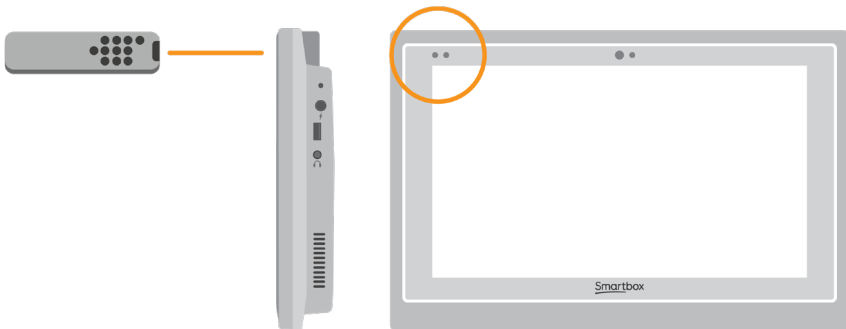

Once complete, the action will turn green and you can test it by tapping Transmit now. Follow these steps for each corresponding action that appears on your remote, then click OK to save and go back to the Environment control window.

Controlling multiple accessories

If you are controlling more than one of the same type of accessory, you can use auto content cells in your Environment Control grid sets. If you have a TV in the bedroom and in the living room for example, you can create two Television auto content cells to choose which TV you are sending commands to.

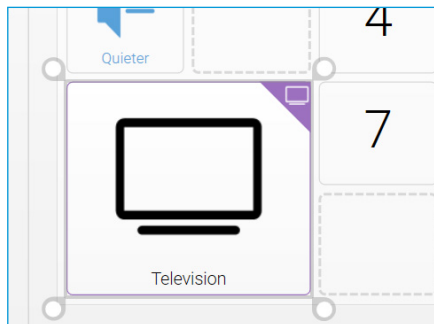

Unique infrared commands

If you have an accessory or toy with only a few functions, you can use the Infrared command to create a cell of a specific action. When you add the Infrared command you will be taken to the Learn Infrared window. Follow the instructions on the screen and click OK to add the command to a cell.

Setting up a radio device

To use an EasyWave or Z-Wave radio device, you must first pair it with your Grid Pad and then configure how it behaves. In the following example we are using an EasyWave socket, however the same instructions apply for Z-Wave devices.

Pairing an EasyWave socket

Go to **Settings - Environment control** and select **Transmitters**. Highlight EasyWave and tap **Configure**.

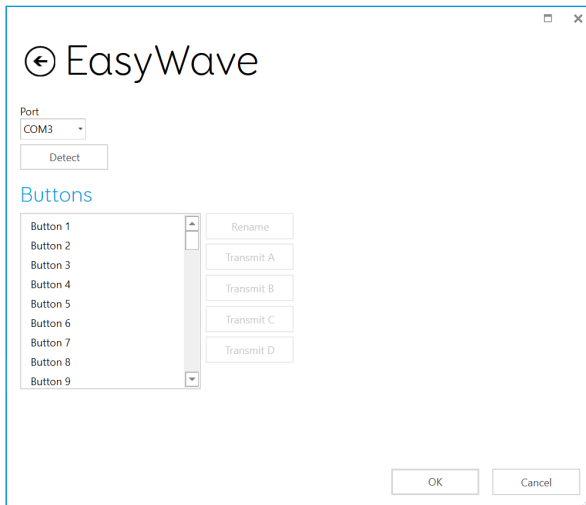

You will need to assign a button to the socket. Select one of the buttons from the menu and click Rename. This will be helpful if you are going to be using more than one socket. Give the button a recognisable name and tap enter.

Plug your EasyWave socket into a mains socket and press the button once to enter training mode. The LED will flash in a steady pattern.

In Grid 3 highlight your newly named button and select Transmit A. On your EasyWave socket, press the button three times. This will return the device to operating mode. You can tap now Transmit A to toggle the switch on and Transmit B to switch it off.

Adding the paired socket to an accessory

Once your socket has been paired, you can assign it to an accessory and use it in the Servus Environment Control grid sets. In **Settings - Environment control**, tap Add under Accessories.

From the Add accessory window select Socket and tap Next.

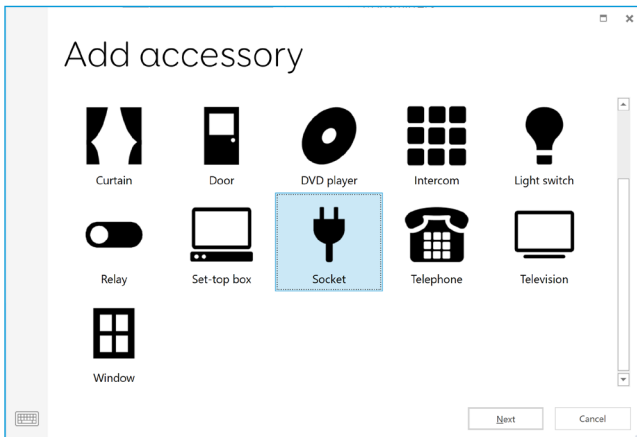

You can now give the accessory a name. This is useful if you are using more than one at the same time. In this example, the socket is controlling a desk fan.

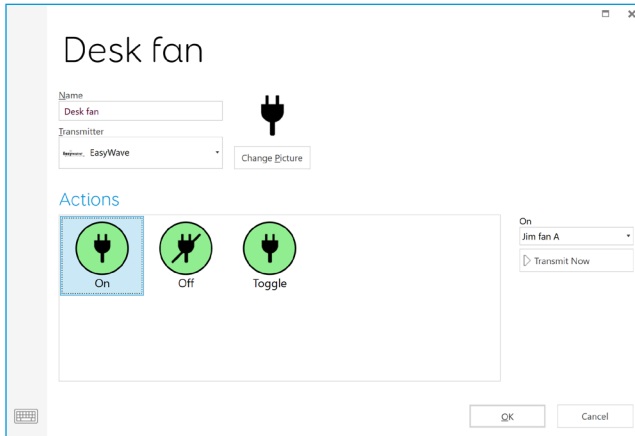

Under actions, select On and choose the name of your button from the drop-down menu (Desk fan A for example). Next select the Off action and assign this to the name of your button followed by the letter B. Tap OK to save your settings and return to the Environment control window.

Your socket will now be listed under accessories and will be ready to use in your Servus Environment Control grid set. To test it, you can use the Fan grid to toggle the socket on and off.

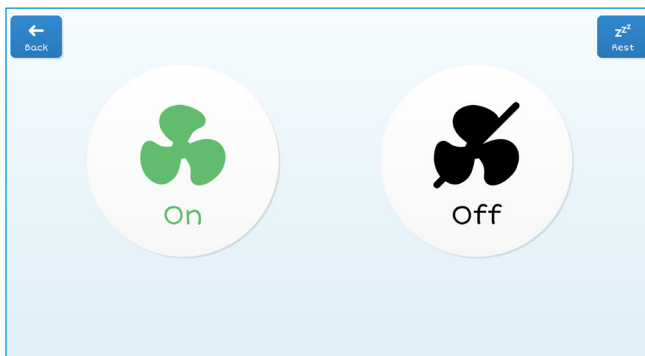

5.6

Connecting a phone to your Grid Pad

Phones supported

We have tested with a wide range of smartphones, both old and new to make sure that the phone feature works as expected, however there are many different devices out there!

We always recommend trying a few options to find the right phone for you before buying.

Android

Android devices running Android 6 and above (Samsung, Google Pixel, Sony and more)

iPhone

iPhone 6 and above running the most recent OS (iOS13 at time of writing)

Open Grid, select the menu and select **Settings - Phone**.

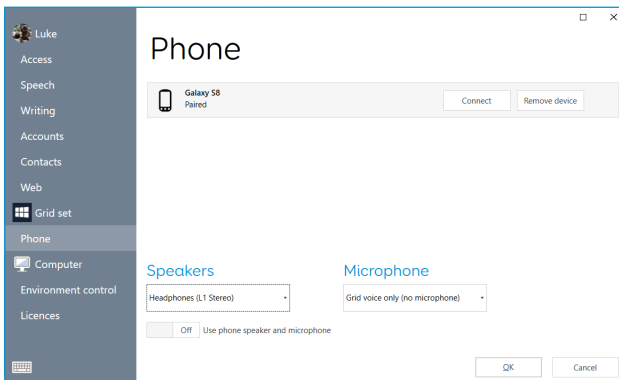

Discoverable phones will appear on the Phone screen.

Tap **Connect** next to your phone to begin pairing.

Your phone will display a notification to confirm, often with a pin code. Select 'Confirm' or 'Yes' on this to continue pairing.

You may also get a couple of additional prompts and notifications on your phone while it pairs. These are to allow Grid access to various functions. Accept all of these.

Once pairing is complete you will see a list of what your phone can do while it is connected to Grid.

Your phone will also begin to sync messages and calls, so you may start to see pop ups in Grid.

In this section

- 6.1 Introducing Grid 3
- 6.2 Adding grid sets
- 6.3 Useful commands to control your Grid Pad from Grid 3
- 6.4 Grid 3 accounts



Grid 3

6.1

Introducing Grid 3

Grid 3 is installed and ready to use on your Grid Pad. This complete AAC software package is designed to help you communicate and connect with the world around you. Everything in Grid 3 can be tailored to suit you and how you want to access your Grid Pad.

Launching Grid 3 on Start-up

Grid 3 is set to open automatically when you start your Grid Pad. You can turn this setting off by opening Grid 3 and navigating to **Settings - Computer** and switching off the Launch Grid 3 with Windows toggle.

You can also change which grid sets are opened when Grid 3 launches. Your grid sets will be listed in the drop-down box under start up.

Adding grid sets

6.2

To add a grid set to your Grid Explorer (the home screen of Grid 3), tap the menu and select Add grid set.

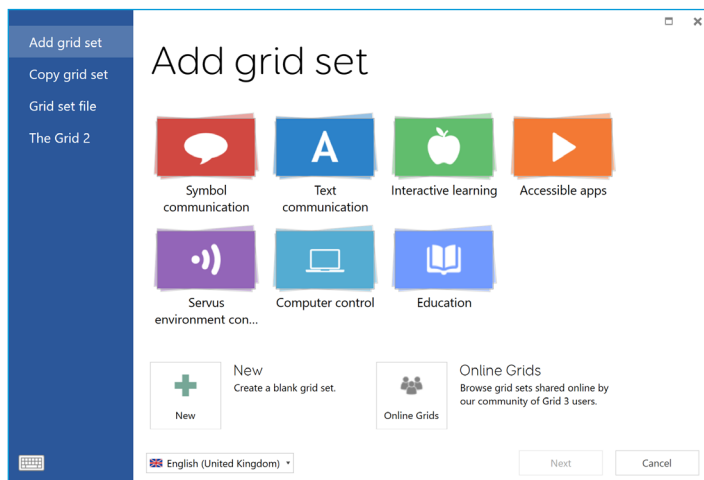

Explore the different categories to choose your grid sets. Each grid set has a description to help you find the right one for your needs. Some categories contain groups of related grid sets within a folder. Once you have selected your grid set, you will see the full description, as well as any alternative versions, with different symbol sets or access options.

New grid sets

To create a grid set from scratch select New from the Add grid set window. From here you can use Grid 3's editing tools to create whatever you need.

Online Grids

Online Grids service enables you to share grid sets and download them to your Grid Pad. Selecting Online Grids from the Add Grid set window you can search and browse shared grids from Smartbox and other users.

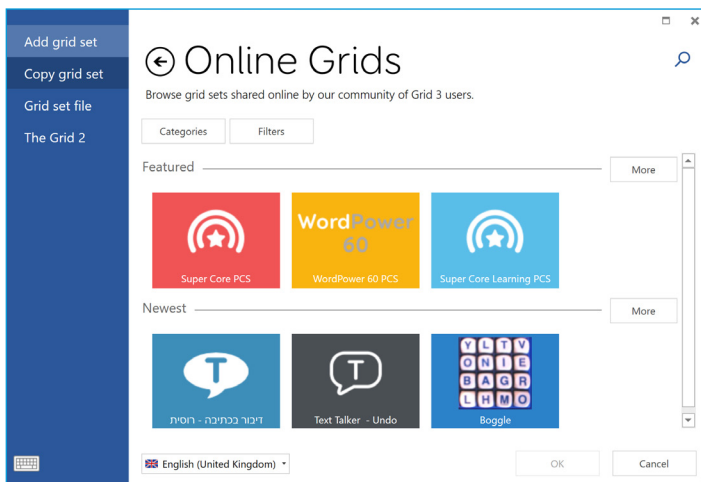

Editing grid sets

Grid 3 comes with a complete set of tools designed to make editing and creating grids simple. Opening edit mode will enable you to make changes to the grid set you are currently using. You can add and remove cells, rows, columns, commands and more.

You can get to edit mode by tapping **Menu - Edit**, or by pressing F11 on a connected keyboard.

For more information on editing grid sets, see the Grid 3 training materials supplied with your Grid Pad.

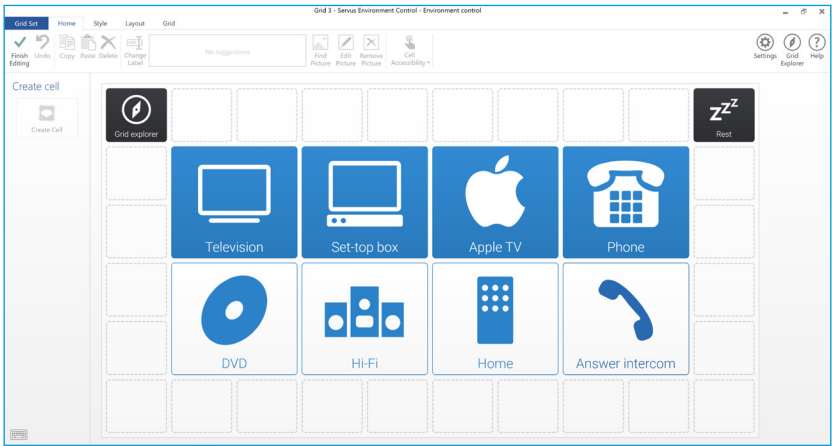

6.3

Useful commands to control your Grid Pad from Grid 3

These commands can be added to cells in your grid sets to control various functions of your Grid Pad directly from Grid 3.

Turn off computer	Shuts down the Grid Pad including all open programs
Sleep screen	Switches off your Grid Pad's screen. Unlike the Standby computer command, you can use your access method to switch the screen back on
Battery	Displays a cell with the remaining battery life as an icon
Battery percentage	Displays a cell with the remaining battery life as a percentage
Grid Explorer	Take you back to Grid Explorer to choose another grid set
Brightness	Cycle through several brightness levels
Rest cell	Deactivate every cell in your grid set, except the Rest cell. This can be used to give you a break when using eye gaze or head pointer access and prevents unwanted activations
Calibrate	Starts a new eye gaze calibration

Grid 3 Accounts



On the **Settings - Accounts** screen you can manage which accounts are connected to Grid 3. You can connect your Email, Smartbox account, Dropbox and any Remote editors who have access to your grid sets.

Email

Grid 3 can connect directly to Outlook, Hotmail, Gmail and Yahoo accounts with your username and password. You can also use POP3/SMTP to connect to other email providers.

Smartbox Account

Your Smartbox account gives you access to Remote Editing, backs up your grid sets in Dropbox, and enables you to share your grid sets via Online Grids. Simply sign in with your email and password or create a new account from within Grid 3.

Dropbox

Connecting Grid 3 to Dropbox enables you to backup your grid sets and sync between devices. Connecting to Dropbox lets remote editors connect to Grid 3 to modify your grid sets from other devices.

Remote editors

From the accounts window you can also list other Smartbox accounts that can remotely edit the grid sets on your device.

In this section

- 7.1 Software updates
- 7.2 Getting the most out of your battery
- 7.3 Cleaning and storing your Grid Pad



Looking after your Grid
Pad

Grid 3 updates

Grid 3 is frequently updated with new features and support for new access methods. If an internet connection is available, Grid 3 will automatically scan for any updates. If an update is available a notification will appear in the top right corner of Grid 3.

Tap the notification icon to open Smartbox update and install the latest version of Grid 3.

To turn off automatic updates, navigate to **Settings - Computer** and turn off the Check for updates toggle.

Tip: You can opt in for early access to updates in Grid 3 under **Settings - Computer**. An early access release could have new features for you to try, but be aware that these are subject to change and may be untested with your device.

Smartbox update

You will find the Smartbox update software in your Start menu by default. Open the program and click Next to begin an automated internet update for all Smartbox software installed on your device. Your Grid Pad will need to be connected to the internet to check for any updates.

Windows updates

Windows update settings are found under **Settings - Update & security** from your Start menu. On this screen you will see the status of any pending updates. You can choose to switch

off automatic updates. Note that this does not stop Microsoft delivering security updates.

Microsoft will roll out larger Windows updates roughly once a year. At Smartbox we will test these internally before we advise when the update is ready for Grid Pad.

Getting the most out of your battery

Grid Pad has a large battery, designed to last all day.

Estimated battery life

We stress test our batteries in a range of situations, from conservative to intensive usage. For more information on how we test our batteries visit:

thinksmartbox.com/battery-life

Your Grid Pad will last for approximately 15 hours, or 10 hours when using eye gaze as your access method.

Viewing your remaining battery life

You can add the Battery command to a cell in your grid set to view your remaining battery life from within Grid 3. In Windows you will need to tap the battery icon in the taskbar at the bottom of your screen to see how much battery life you have remaining.

Making the most of your battery

There are a number of features to help you keep talking even longer.

Sleep screen

You may wish to take some time away from your device, or turn off the screen to watch TV for example. Sleep screen enables you to turn the Grid Pad screen off when you choose, and wake it up

again using your chosen access method.

Once activated, the Sleep screen command will power down the screen, without shutting the device down entirely. To reactivate the screen, you will need to activate your access method again. If you are using eye gaze, gazing at the centre of the screen will reawaken your device.

You can customise your Sleep screen settings by going to **Settings - Computer**. Here you can turn on automatic dimming, the length of time before the screen automatically turns off and the dwell time to wake with eye gaze.

Brightness commands

Use the Set brightness commands in Grid 3 to increase or decrease the brightness of the screen. If you are looking to conserve battery, having the brightness set to low can help. Smartbox recommends the brightness of the screen be set to 70%.

Cleaning and storing your Grid Pad

Cleaning your device

The front glass of your Grid Pad can be cleaned using a microfibre cloth. Your Grid Pad should be cleaned regularly with an antibacterial wipe. You can also use alcohol-based wipes to clean both the screen and the outer case of the Grid Pad.

Do not use spray cleaning fluid, gel, or polish directly onto your Grid Pad, or immerse the device in water.

Storing your Grid Pad

When not in use, your Grid Pad should be stored safely. Do not rest or press hard objects against the screen. Disconnect any devices plugged into the ports of the Grid Pad, including USB ports, switch ports and the power lead.

Storing the remote power button

When packing away your Grid Pad, we recommend removing the AAA batteries from the remote power button and disconnecting any switches.

Blank page with horizontal lines.

In this section

- 8.1 Smartbox support
- 8.2 Grid Pad specification
- 8.3 Device specification
- 8.4 Symbol explanation
- 8.5 Safety notices
- 8.6 Statement of compliance
- 8.7 Battery warnings



Appendices

8.1

Smartbox support

Online support

The Smartbox team is here to help you make the most of your Grid Pad and Grid 3. You can raise a support ticket over email, use our online chat box or search our knowledge base of support articles.

thinksmartbox.com/smart-support

Online chat

Online chat support is available from our website. Opening hours are listed in the chat window.

Tip: You can also access our Online Chat directly from your Windows Start menu.

Remote support in Grid 3

Our support team can use a remote connection to deliver hands on support over an internet connection. If you are asked to create a remote support session you can do this directly in Grid 3. Go to **Menu - Help** and select Remote Support.

Knowledge Base

Our Smartbox Knowledge base is full of tips, guides and troubleshooting tools to help you get the most from your Grid Pad and Grid 3.

thinksmartbox.com/knowledge-base

Other support

You can reach our UK support team between 9am – 5:30pm (5pm Friday) by phone:

+44 (0) 1684 578868

If your Grid Pad was supplied outside of the UK, please contact your local Smartbox Partner. You can find our list of international partners at:

thinksmartbox.com/where-to-buy

Facebook community

Our Facebook Community is a great way to get in touch and keep up with the latest news. This group of Smartbox users is growing everyday and is the perfect place to ask for advice, share ideas and find inspiration.

If you have any questions, our network of assistive technology specialists, Smartbox Users, parents, carers and therapists will be on hand to help you out.

thinksmartbox.com/facebook

8.2

Grid Pad specification

Device

Processor:	Intel Core i5-7Y54, 4mb cache, up to 3.20GHz
RAM:	8GB DDR3
Hard disk drive:	SSD SATA III, 128GB
Operating System:	Windows 10 Pro
Display:	12.5 inch 1920 x 1080 with anti glare

Access

2 x 3.5mm switch ports
3.5mm Headphone / microphone combo port
1 x USB 2.0 port
1 x USB 3.0 port

Eye Gaze

Optional Grid Pad Eye Gaze Camera (sold separately)

Environment control

GEWA Infrared
EasyWave or Z-Wave radio

Mounting

Built-in stand
Mounting plate (Daessy and Rehadapt)

Connectivity

Dual band wireless AC 8265
Bluetooth 4.2 LE

Other information

Front camera:	2mp
Rear camera:	5mp
Battery life:	15 hours
Battery life with eye gaze:	10 hours
Charge time:	8 hours
Dimensions:	335 x 223 x 45mm
Weight:	2.7Kg

8.3

Device specification

Grid Pad is a communication aid designed for people with disabilities who cannot speak or have complex access needs.

Model Number: GP12

FCC ID: 2APXM-GP12V1





Operating environment

- Temperature: 0 - 40°C
- Relative humidity: 0 - 90%
- Atmospheric pressure: 70 kPa to 106 kPa

Storage environment

- Temperature: -20°C - 60°C
- Relative humidity: 0 - 90%
- Atmospheric pressure: 50 kPa to 106 kPa

Symbol explanation

Symbol	Meaning
	Headphone port
HDMI	High definition media input port
	Charging port
S1	Switch port 1
S2	Switch port 2
CE	Conformity European symbol to declare conformity with EU legislation.
FC	Federal communications commission symbol to declare conformity with US legislation.
	Waste electrical and electronic equipment symbol to indicate you should dispose of this equipment in accordance with local regulations.
	Power button symbol
+	Increase volume symbol
-	Decrease volume symbol
	Read the manual symbol

8.5

Safety notices

Grid Pad 12 has been tested as a Class 1 medical device. Specifications and standards have been listed in the Compliance section of this manual.

Please consider these safety warnings to ensure safe operation of your Grid Pad.

Application

Grid Pad is a communication aid designed to assist and augment your quality of life. It has been designed and manufactured to be extremely robust and reliable, but it is possible to lose function due to power loss or other technical issues.

For this reason your Grid Pad:

- is not to be used as a life supporting device.
- is not be relied upon for well-being.
- is not to be relied upon as the user's only way of making an emergency call or alarm.
- should not be used to administer medicine.

Your Grid Pad's GEWA Infra-Red Control is not to be relied upon as the only method of interaction with IR controlled devices.

Avoiding hearing damage

Using headphones and speakers at high volume can cause permanent hearing loss. Always keep the volume of your device at a safe level.

Durability

Your Grid Pad is tough and rugged but must be handled with care when moving around. It has been drop tested to one metre. Please note this does not include accessories.

Water and liquids

Your Grid Pad has an IP54 rated screen to withstand light rain and for ease of cleaning. It should not be exposed to heavy rain or immersed in water.

The back of your device is not protected. Do not get water or liquids on the back of the device, especially in the ports or vents.

Contact with user

Part	Max continuous contact time
Touch screen	1 min
Plastic enclosure of Grid Pad	10 min
Button	10 min

Accessible part	Maximum temperature while device is charging (40oC ambient temp)	Maximum temperature while device is not charging (40oC ambient temp)
Touch panel	50.1	49.7
Plastic enclosure	48.5	48.4
Button	43.6	43.6

Do not touch the surface of your Grid Pad with broken or burnt skin as this may aggravate wound.

Power supply and batteries

Your Grid Pad contains a rechargeable lithium ion battery. All rechargeable batteries degrade over time. The usage time for a Grid Pad after a full charge can become shorter over time.

For optimal performance your Grid Pad should not be charged at extreme temperatures of below 0°C or above 45°C. At these temperatures your battery will charge slowly or not at all.

Do not expose your Grid Pad to fire or temperatures above 90°C as these conditions can cause the battery to malfunction, ignite or explode.

Only charge your Grid Pad with the supplied power lead. Using unofficial power supplies may cause severe damage to your Grid Pad and cause fire. If your Grid Pad’s power lead is lost or damaged, contact your supplier.

When your Grid Pad's battery is depleted, and the device is not connected to a power source, the device will automatically shut down to avoid damaging the battery and hardware. The operating system will attempt to do this as safely as possible, however it is recommended to attach the power lead before your Grid Pad shuts down.

The battery that powers your Grid Pad is subject to shipping regulations. Check with your postal service or courier before shipping to ensure safe delivery of your device.

Do not place your device in a place where power adaptor plug is hard to be disconnected from socket.

Do not replace battery yourself. Return your device to its supplier for the battery to be serviced.

Transporting your Grid Pad

When in transit, ensure your Grid Pad is sufficiently protected from knocks and bumps.

There are strict regulations for lithium ion batteries on airplanes. Rules vary between airlines, so it is recommended to contact your airline before you travel. More information can be found here:

caa.co.uk/passengers/before-you-fly/baggage/items-that-are-allowed-in-baggage

Temperature

Do not block the vents.

Ensure that you shut down your device before storing or placing into a bag.

If used in hot temperatures or direct sunlight, your Grid Pad may reach temperatures that can trigger an automatic shutdown. This is a safety feature to prevent lasting damage to the device. If this occurs, please wait until your device has cooled before restarting.

Mounting

When mounting your Grid Pad, follow the instructions in both your Grid Pad and your mounting system manufacturer's guide. While we have taken every precaution to make this an easy and safe process, it is up to you to ensure the device is mounted safely.

Please use the Daessy or Rehadapt mounting solutions provided. Ensure the mounting system you select is correct for you needs and perform a risk analysis if required.

Other safety

If damaged, small parts may detach from your Grid Pad. These can present a choking hazard. Young children and people with cognitive disabilities should be supervised when using the device. They should also be supervised when unpacking the device as packaging can present a choking hazard.

Grid Pad is not sterile. Do not operate with open wounds, or whilst undergoing invasive medical treatments.

Grid Pad is supplied with a power cable and can be used with cabled accessories. These can present a strangulation hazard.

Epilepsy warning

Some people with photosensitive epilepsy are susceptible to seizures when exposed to certain lights or light patterns. If you feel odd or nauseous when in front of your Grid Pad, particularly if you are using it with an eye gaze camera, move away from the device and consult a medical professional.

Eye gaze safety

Prolonged use of an eye tracking device may strain eye muscles. Take frequent breaks and rest if eye fatigue is noticed.

Disposing of your Grid Pad

Do not dispose of your Grid Pad in general household or office waste. Your Grid Pad should be disposed of in accordance with local regulations for the disposal of electrical and electronic equipment.

Warranty

Your Grid Pad is covered under the standard 2 year warranty from the time of purchase.

Repairs and Maintenance

Your Grid Pad is not a user serviceable device. If your device requires a repair, please contact your local dealer.

EMC and Harsh Environments

When the device is working with other equipment, there may be inference between device and connecting equipment.

Grid Pad should not be used:

- in a military environment.
- in a harsh RF environment.
- in an MRI environment.
- in an X-ray environment.

Troubleshooting and Customer Support

In most cases, restarting your device will cure any problems. To restart your device, Select Start and then select **Power - Shut down**. If your device has crashed, hold down the power button or remote power button for 5+ seconds to hard shutdown. Press it again to turn it back on.

If this does not fix the problem, contact support at:

thinksmartbox.com/smart-support

Please have your serial number ready. This can be found under the stand on your device.

Statement of compliance

8.6

EU / CE Statement

Hereby, Smartbox Assistive Technology Ltd. declares that this radio equipment complies with Directive 2014/53/EU. The frequencies used by the wireless networking feature of this product are the 2.4 GHz range.

The full text of the EU declaration of conformity is available here: thinksmartbox.com/GP12-DOC

Applicable Directives

This equipment complies with the requirements of the EU harmonised legislation; Medical Devices Directive 2007/47/EC (including EMC Directive 2014/30/EU and LVD Directive 2014/35/EU), Medical Devices Directive 93/42/EEC as amended by 2007/47/EC, RoHS Directive 2011/65/EU. WEEE Directives 2012/19/EU.

Directives and Standards

EN 60601-1:2006/A1:2013

Medical electrical equipment - Part 1: General requirements for basic safety and essential performance

EN 60601-1-2:2015

Medical electrical equipment - Part 1-2: General requirements for basic safety and essential performance - Collateral Standard: Electromagnetic disturbances - Requirements and tests

EN ISO 14971:2012

Medical devices - Application of risk management to medical devices

EN 61000-3-3:2013

Electromagnetic compatibility (EMC) - Part 3-3: Limits - Limitation of voltage changes, voltage fluctuations and flicker in public low-voltage supply systems, for equipment with rated current ≤ 16 A per phase and not subject to conditional connection

EN 50581:2012

Technical documentation for the assessment of electrical and electronic products with respect to the restriction of hazardous substances

WEEE Directives 2012/19/EU

Waste Electrical and Electronic Equipment

FCC Statement

For use in North America

USA - Contains FCC ID: 2APXM-GP12V1

NOTE: This equipment has been tested and found to comply with the limits for a Class B digital device, pursuant to part 15 of the FCC Rules. These limits are designed to provide

reasonable protection against harmful interference in a residential installation. This equipment generates, uses and can radiate radio frequency energy and, if not installed and used in accordance with the instructions, may cause harmful interference to radio communications. However, there is no guarantee that interference will not occur in a particular installation. If this equipment does cause harmful interference to radio or television reception, which can be determined by turning the equipment off and on, the user is encouraged to try to correct the interference by one or more of the following measures:
Reorient or relocate the receiving antenna.

Increase the separation between the equipment and receiver.
Connect the equipment into an outlet on a circuit different from that to which the receiver is connected.

Consult the dealer or an experienced radio/TV technician for help.

For use in Canada

Canada - Contains IC: 1000M-8265NG

Industry Canada Class B Emissions Compliance Statement
This Class B digital apparatus complies with Canadian ICES-003.

Under Industry Canada regulations, this radio transmitter may only operate using an antenna of a type and maximum (or lesser) gain approved for the transmitter by Industry Canada. To reduce potential radio interference to other users, the antenna type and its gain should be so chosen that the equivalent isotropically

radiated power (e.i.r.p.) is not more than that necessary for successful communication.

This device complies with Industry Canada licence-exempt RSS standard(s). Operation is subject to the following two conditions: (1) this device may not cause interference, and (2) this device must accept any interference, including interference that may cause undesired operation of the device.

Conformément à la réglementation d'Industrie Canada, le présent émetteur radio peut fonctionner avec une antenne d'un type et d'un gain maximal (ou inférieur) approuvé pour l'émetteur par Industrie Canada. Dans le but de réduire les risques de brouillage radioélectrique à l'intention des autres utilisateurs, il faut choisir le type d'antenne et son gain de sorte que la puissance isotrope rayonnée équivalente (p.i.r.e.) ne dépasse pas l'intensité nécessaire à l'établissement d'une communication satisfaisante.

Le présent appareil est conforme aux CNR d'Industrie Canada applicables aux appareils radio exempts de licence. L'exploitation est autorisée aux deux conditions suivantes : (1) l'appareil ne doit pas produire de brouillage, et (2) l'utilisateur de l'appareil doit accepter tout brouillage radioélectrique subi, même si le brouillage est susceptible d'en compromettre le fonctionnement.



Battery warnings

8.7

Do not dismantle, open or shred the battery.

Do not expose the batteries to heat or fire, and avoid storage in direct sunlight.

Do not short-circuit the battery.

Do not store the battery haphazardly in a box or drawer where it may be short-circuited by other metal objects.

Do not subject the battery to mechanical shock.

In the event of a battery leaking, do not allow the liquid to come in to contact with the skin or eyes. If contact has been made, wash the affected area with copious amounts of water and seek medical advice.

Do not use any charger other than that specifically provided for use with the equipment, and refer to the manufacturer's instructions or equipment manual for official charging instruction.

Do not use any other battery with the equipment unless approved by Smartbox.

Battery usage by children should be supervised.

Keep the battery clean and dry.

Wipe the battery with a clean dry cloth if it becomes dirty.

Do not leave a battery on prolonged charge when not in use.

After extended periods of storage, it may be necessary to charge and discharge the battery several times to obtain maximum performance.

Retain the original product literature for future reference.

Only use the battery in the application for which it was intended.

When possible, remove the battery from the equipment when not in use.

Dispose of the battery according to local regulations.

Notes

Grid 12

Smartbox
thinksmartbox.com

GP12-MAN-B