



Careturner® for Wissner-Bosserhoff Sentida 6

en	Accessory for Wissner-Bosserhoff Sentida 6 User Manual	3
----	---	---



CE This manual MUST be given to the user of the product.
BEFORE using this product, read this manual and save for
future reference.



©2019 GDV Technology A/S

All rights reserved. Republication, duplication or modification in whole or in part is prohibited without prior written permission from GDV .
Trademarks are identified by TM and ®. All trademarks are owned by or licensed to GDV Technology A/S or its subsidiaries unless otherwise noted.

—

Contents

This manual MUST be given to the user of the product.
BEFORE using this product, read this manual and save for future reference.

1 General	4
1.1 Introduction	4
1.1.1 Definitions	4
1.2 Symbols in this document	4
1.3 Intended use	4
1.4 Service life	4
1.5 Warranty information	4
1.6 Limitation of liability	4
1.7 Compliance	5
2 Safety	5
2.1 General safety information	5
2.2 Labels and symbols on the product	6
2.2.1 Product label	6
2.2.2 Other labels and symbols	6
3 Setup	7
3.1 General Safety Information	7
3.2 Scope of delivery	7
3.3 Mounting the Careturner	7
4 Usage	10
4.1 General Safety Information	10
4.2 Overview	10
4.3 Control Box and Hand Control	10
4.4 On/Off and Reset function	10
4.5 Emergency Stop	11
4.6 Manual operation	11
4.6.1 Recommended Procedures	11
4.7 Automatic operation	11
4.7.1 Auto program sequence	12
4.7.2 Pause automatic operation	12
4.8 Charging the battery	12
4.9 Emergency release of the wing	12
5 Programming	13
5.1 Individually defined programs	13
5.2 How to program the individual automated programs	14
5.3 Program examples for automated pressure relief	16
6 Maintenance	17
6.1 General Maintenance Information	17
6.2 Cleaning and disinfection	17
6.3 Battery	17
7 After Use	18
7.1 Disposal	18
7.1 Reconditioning	18
8 Troubleshooting	19
8.1 Troubleshooting the electrical system	19
8.2 Programming Errors	20
9 Technical Data	21
9.1 Characteristics	21
9.2 Weights	21
9.3 Allowed mattress sizes	21
9.4 Environmental conditions	21
9.5 Electrical system	21
10 Electromagnetic compatibility (EMC)	23
10.1 General EMC Information	23
10.2 Electromagnetic mission	23
10.3 Electromagnetic Immunity	23
10.3.1 Test specifications for immunity to RF wireless communications equipment	24

1 General

1.1 Introduction

This document belongs to an GDV accessory and it contains important information about handling and assembly. To ensure safety when using the product, read the user manual of the related product carefully and follow the safety instructions.

Find the user manual on GDV's website or contact your GDV representative. See addresses at the end of this document. GDV reserves the right to alter product specifications without further notice.

Before reading this document, make sure you have the latest version. You find the latest version as a PDF on the GDV's website.

If you find that the font size in the printed document is difficult to read, you can download the PDF version from the website. The PDF can then be scaled on screen to a font size that is more comfortable for you.

In case of a serious incident with the product, you should inform the manufacturer and the competent authority in your country.

1.1.1 Definitions

All references to left and right are based on a person lying on his back in the bed, with his head in the head end.

1.2 Symbols in this document

Symbols and signal words are used in this document and apply to hazards or unsafe practices which could result in personal injury or property damage. See the information below for definitions of the signal words.



WARNING
Indicates a hazardous situation that could result in serious injury or death if it is not avoided.



CAUTION
Indicates a hazardous situation that could result in minor or slight injury if it is not avoided.



IMPORTANT
Indicates a hazardous situation that could result in damage to property if it is not avoided.



Tips and Recommendations
Gives useful tips, recommendations and information for efficient, trouble-free use.

1.3 Intended use

The Careturner and control unit is intended to be used only in conjunction with 90 cm wide Wissner-Bosserhoff Sentida 6 beds, equipped with side rails in an appropriate height (see chart in 9 *Technical Data*, page 21), side rail covers and foam mattress (see size chart 9 *Technical Data*, page 21)

- As a part of an overall pressure ulcer prevention programme of care.
- To move bedridden end-users to lay on left or right side or on the back.
- Support the end-user in getting in and out of bed.

- When used in the "automatic" mode it has been designed to provide pressure reduction to end-users.
- When used in the "manual" mode it is designed to support the care staff in turning the end-user from side to side in the bed.
- It is suitable for use in all home care, residential and nursing care settings.
- It is suitable only for indoors use.

Indications

The intended patient group for Careturner is:

- Bedridden immobile/partially immobile adult end-users.
- Who needs pressure care.
- Who needs to be nursed in the care bed such as personal hygiene, dressing etc. This group of end users will often be transferred from bed to chair using a lifter or manually supported by care staff in combination with a technical aid such as a rollator.

Contraindications

The Careturner is not intended for psychiatric, restless or anxious end-users or persons with spasm.

Precautions

- Before the Careturner is used it is important to evaluate, if Careturner is suitable for the actual end-user.
- For security reasons the end-user must not operate the Careturner themselves.



WARNING!

Any other or incorrect use could lead to hazardous situations. GDV accepts no liability for any use, change or assembly of the product, other than stated in this user manual.

1.4 Service life

The expected service life of this product is five years when used daily and in accordance with the safety instructions, maintenance intervals and correct use, stated in this manual. The effective service life can vary according to frequency and intensity of use.

1.5 Warranty information

We provide a manufacturer's warranty for the product in accordance with our General Terms and Conditions of Business in the respective countries.

Warranty claims can only be made through the provider from whom the product was obtained.

1.6 Limitation of liability

GDV accepts no liability for damage arising from:

- Non-compliance with the user manual
- Incorrect use
- Natural wear and tear
- Incorrect assembly or set-up by the purchaser or a third party
- Technical modifications
- Unauthorized modifications and/or use of unsuitable spare parts

1.7 Compliance

This product features the CE mark, in compliance with the Medical Device Regulation 2017/745 Class 1. The launch date of this product is stated in the CE declaration of conformity.

2 Safety

2.1 General safety information



WARNING!

Compatibility with Wissner-Bosserhoff Sentida 6 beds only

The Careturner is specially designed and must only be used in conjunction with 90 cm wide Wissner-Bosserhoff Sentida 6 beds.



WARNING!

Risk of falling

If the Careturner is used without or with the wrong side rails, there is a risk for the end-user to fall out of the bed.

- Never use the Careturner on a bed without side rails.
- Only use the Careturner in combination with side rails listed in *9 Technical Data, page 21*.
- Always make sure the side rail is up in the opposite site of where the care staff is placed OR one care staff is placed on each side of the bed, when the manual mode is used.
- Always make sure both side rails are up, when the automatic mode is activated.



WARNING!

Risk of squeezing and/or suffocation

If the side rails are used without a cover or with a non-breathable cover, there is a risk of squeezing and/or suffocation for the end-user.

- Always use a breathable cover for the side rails when using the Careturner.



WARNING!

Risk of falling and/or squeezing

If the side rails are used without a cover or with a non-breathable cover, there is a risk of squeezing and/or suffocation for the end-user.

- Always perform a risk assessment of the end-user's condition and ability of moving.
- Never use the Careturner if the end-user is anxious or restless.
- Always make sure the end-user is placed in the middle of the bed and all body parts are on the mattress before the wings are moved.
- Never leave the end-user unattended when the manual mode is used.
- The end-user must never get in or out of the bed while the wings are moved manually or the automatic mode is activated.
- The hand control must always be used by care giver.



WARNING!

Risk of injury or damage to property

Inappropriate handling of cables can cause electrical shock and product failure.

- Do not kink, shear or otherwise damage the main power cord.
- Do not roll the castors over the main power cord.
- Do not bring main power cord into moving parts.
- Disconnect the plug from the mains before moving the bed.
- Make sure that no cables (mains or from other equipment) are jammed or damaged, when the bed is used.
- Keep bed components and accessories at least 30 cm away from a heated surface and not in direct sunlight.

Mattresses



WARNING!

Safety aspects regarding combination of side rails and mattresses:

To get the highest possible safety level, when using side rails on the bed, the minimum and maximum measures for mattresses, must be respected.

- For correct mattress measures see mattress tables in chapter *9 Technical Data, page 21*.



WARNING!

Risk of entrapment and/or suffocation

To get the highest possible safety level, when using side rails on the bed, the minimum and maximum measures for mattresses, must be respected.

- The end-user could get trapped and/or suffocate, if the horizontal space, between the mattress side and the inside of the side rail, is too big. Follow the minimum width (and length) of mattresses in combination with a side rail, as stated in the mattress table in chapter *9 Technical Data, page 21*.
- Be aware that using very thick or soft mattresses (low density), or a combination of these, increases the risk.

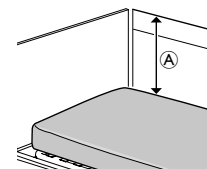

WARNING!

Risk of falling

The end-user can fall over the edge and get seriously injured, if the vertical distance **A** between the top of the mattress and the edge of the side rail/bed end, is too short. See image above.

- Always keep a minimum distance **A** of 22 cm on the side of the wing the user is lying on (secondary wing elevated to max. 12°).
- Follow the maximum mattress height in combination with the side rail as stated in the mattress table in chapter *9 Technical Data, page 21*.

Electromagnetic interference



WARNING!

Risk of malfunction due to electromagnetic interference

Electromagnetic interference between this product and other electrical equipment can occur and disturb the electrical adjustment functions of this product. To prevent, reduce or eliminate such electromagnetic interference:

- Only use original cables, accessories and spare parts, to not increase electromagnetic emission or reduce electromagnetic immunity of this product.
- Do not use portable radio frequency (RF) communications equipment closer than 30 cm to any part of this product (including cables).
- Do not use this product near active high-frequency surgical equipment and the RF shielded room of a system for magnetic resonance imaging, where the intensity of electromagnetic disturbances is high.
- If disturbances occur, increase the distance between this product and the other equipment or switch it off.
- Refer to the detailed information and follow the guidance in chapter 10 *Electromagnetic compatibility (EMC)*, page 23.

2.2 Labels and symbols on the product

2.2.1 Product label

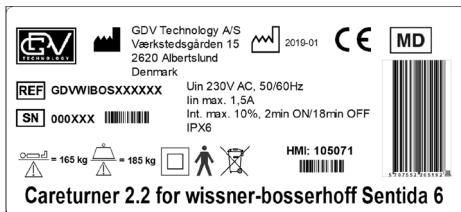

The product label is placed on the main module of the Careturner and contains the main product information, including technical data.

Symbol

	Serial Number
	Reference Number
	Manufacturer Address
	Manufacturing Date
	Max. User Weight
	Max. Safe Working Load
	Type B Applied Part
	WEEE conform
	European conformity
	Medical device
	Insulation Class 2
	Recyclable battery

Abbreviations for technical data:

- Iin = Incoming Current
- Uin = Incoming Voltage
- Int. = Intermittence
- AC = Alternating Current
- Max = maximum
- min = minutes

For more information about technical data, refer to 9 *Technical Data*, page 21.

2.2.2 Other labels and symbols

	Read carefully the user manual before using this product and follow all instructions for safety and use.
	Indicates the correct placement and orientation of the Careturner main module on the bed. See 3.3 <i>Mounting the Careturner (Mounting the main module)</i> , page 7.
	Indicates the correct placement of the head and foot arms to the main module. See 3.3 <i>Mounting the Careturner (Mounting the arms and cover)</i> , page 9.
	Indicates the correct placement of the cover on the Careturner. See 3.3 <i>Mounting the Careturner (Mounting the arms and cover)</i> , page 9.

3 Setup

3.1 General safety information

When you receive the product, check the packaging. If the packaging shows any signs of damage upon delivery, contact the shipping company.



WARNING!

Risk of injury or damage to property

The assembly and installation must be done by authorized or trained personnel.

- This Careturner version is specially designed and must only be used in conjunction with 90 cm wide Wissner-Bosserhoff Sentida 6 beds.
- Follow instructions carefully. If you have any question regarding the assembly, contact your local dealer or GDV representative.
- If the product shows any sign of damages, do not use the product. Contact your local dealer or GDV representative.
- The electrical equipment of the product must not be dismantled or combined with other electrical equipment.
- After each assembly, check that all fittings are properly tightened and that all parts have the correct function.

3.2 Scope of delivery

The Careturner is delivered partially assembled in a cardboard box.

Main Parts

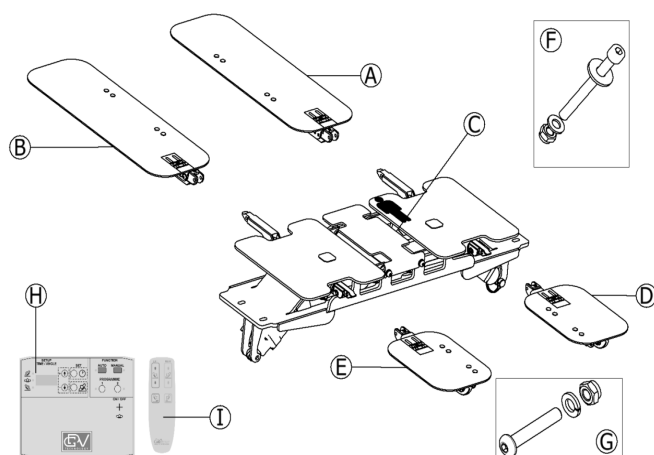

- Ⓐ Head end arm of left wing
 - Ⓑ Head end arm of right wing
 - Ⓒ Main module (pre-assembled unit)
 - Ⓓ Foot end arm of left wing
 - Ⓔ Foot end arm of right wing
 - Ⓕ 4 sets: Carriage-bolt, washers and lock nut
 - Ⓖ 4 sets: Allen-bolt, safety washer and lock nut
 - Ⓗ Control Box
 - Ⓘ Hand Control
- Textile cover (not shown in image)

3.3 Mounting the Careturner

Mounting the main module



WARNING!

Risk of injury or damage to property

Holding the main module at wrong parts while lifting, can cause product damage or injury.

- Only hold the main module at the cover plates of the wings or the mounting brackets on the base frame, where the lift here stickers are placed.
- Do not hold on the middle cover plate.

1.

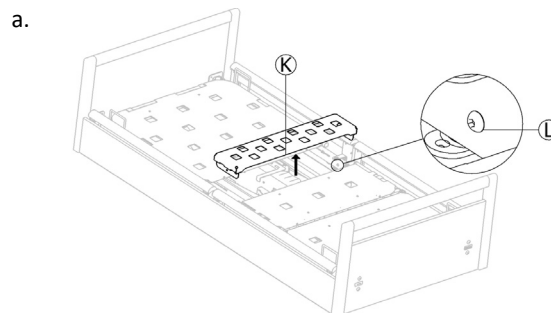

Remove the middle cover Ⓚ, by removing the bolt shown in the zoomed image Ⓛ using a 5 mm Allen key on both sides of the bed, and keep all parts available for remounting when the Careturner is removed from the bed.

b.

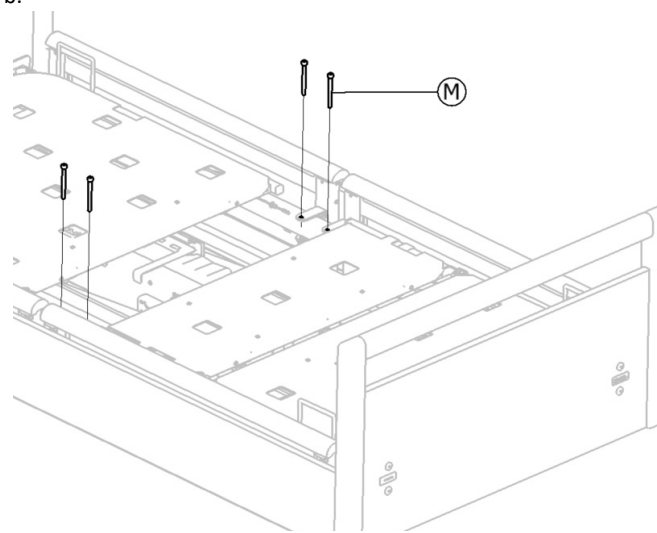

Remove the 4 bolts Ⓜ by using a 13 mm key and a 6 mm Allen key, keep the bolts and nuts available for remounting when the Careturner is removed from the bed.

2.

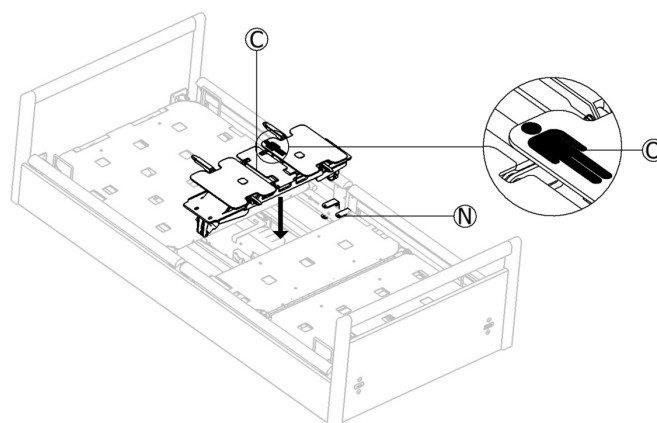

Place the main module ③ onto the bed brackets ④, following the symbol represented in the zoomed image ⑤. Head facing towards the head end of the bed and feet towards the foot end of the bed.

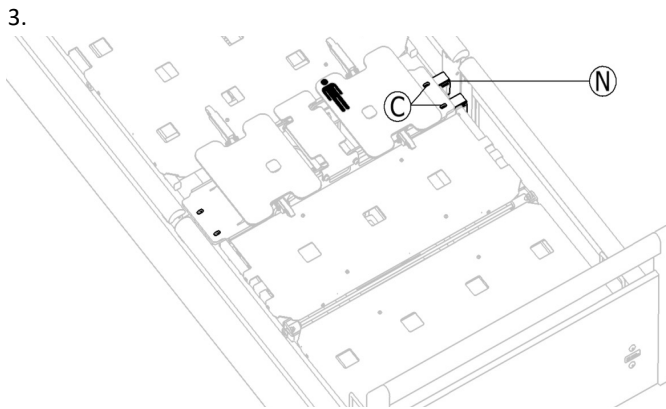

Ensure that the main module is placed on the bed support brackets ④ with the slots on the main module ③ concentric with the holes on the brackets ④, so a bolt can fit through.

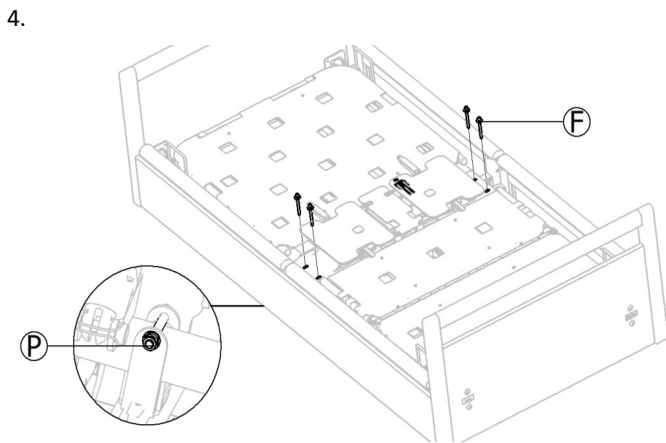

Fix the main module to the bed by placing the four carriage-bolts ⑥ with the wide washer through the top of the main module and bed support bracket. Place the normal washers on the bolts under the bed and tighten the lock nuts ⑦ with a 13 mm key, and a 6 mm Allen key from the top.

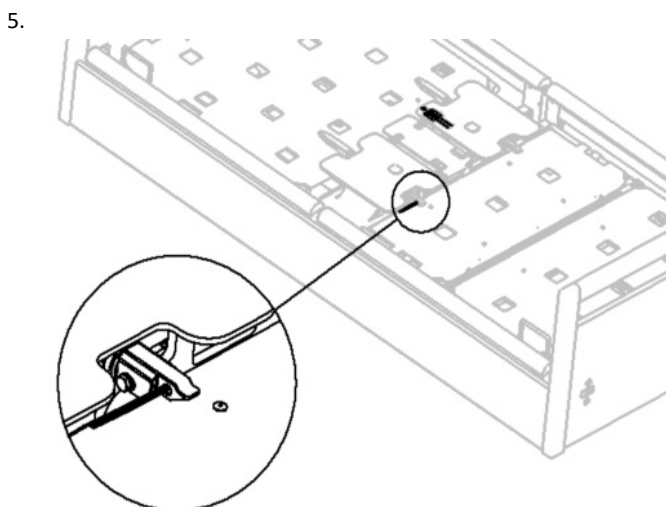

Cut all the zip ties in order to release the top wings.

Wiring

The control box and hand control is to be hung at the footboard.



Connections at the control box

- ① Power supply
- ② Hand control
- ③ Right motor
- ④ Left motor



Run the motor cable underneath the bed frame toward the foot end (indicated by the arrow in the image), on both sides of the bed and fix each of the cables with zip ties onto the frame tube. Ensure that both motor cables are tightened with zip ties (marked by the circles in the picture), first zip tie near the motor and the last 3 on the frame tube toward the foot end. Make sure the end of the zip ties, are not facing outwards from the bed frame.

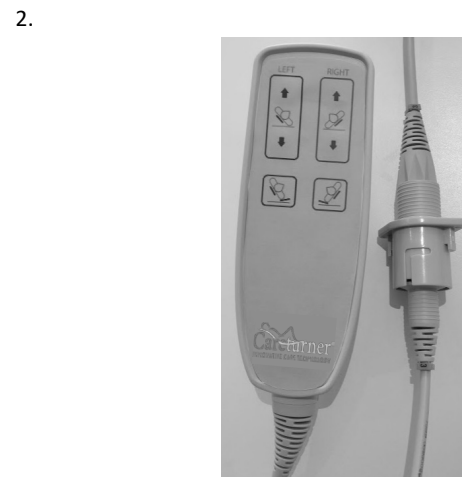

Connect the hand control to cable ② and connect the power cable ① to the mains. The hand control cable is marked ③ on the cable clip corresponding to ③ on the control box cable.

3.

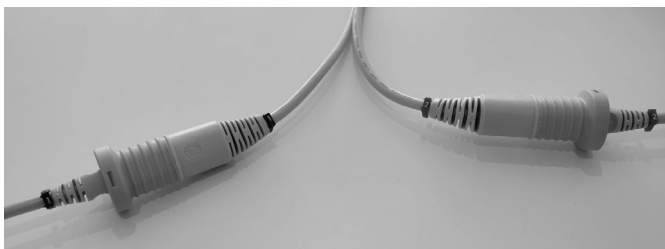

Connect the cables of the right and left motor to the two extension cables ⑤ and ① from the control box. The right motor cable is marked ① on the cable clip corresponding to ① on the cable from the control box and the left motor cable is marked ② on the cable clip corresponding to ② on the control box cable. Deactivate the emergency stop, turn the system on, activate manual mode and use the hand control to check that the left and right motor are correctly connected to the control box (see chapter *Usage* for detailed instructions).

 Ensure that all cables run underneath the bed frame tubes and move the bed all the way up and down to ensure no cables are getting squeezed.

4.



Collect the motor cables in a bundle and tighten it with a zip tie, move the bed up and down to make sure that the bundle is not clinging on any bed parts and moves freely.

Mounting the arms and cover

1. Ensure both wings of the main module are slightly elevated, so the connections for the arms are accessible.
- 2.

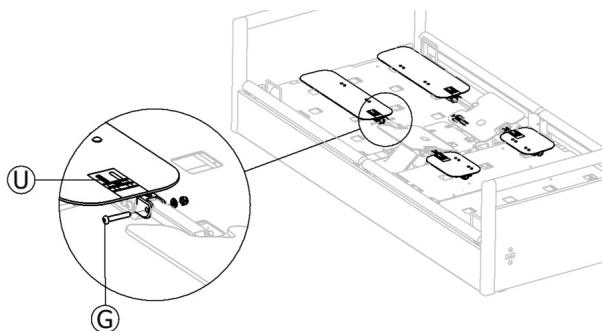

Connect the four arms with the main module, following the representation on the arms label shown in the zoomed image ④, the black shaded area on the sticker represents the location where the arm must be placed. Fix the four arms with the Allen bolts from set ⑥ and tighten the lock nuts facing inwards. Ensure the safety washers are placed on the lock nut side.

3

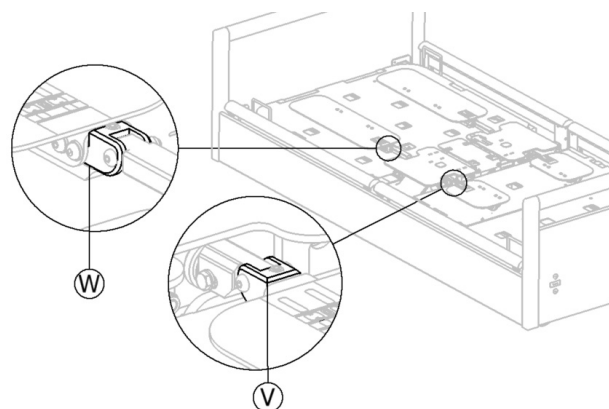

Ensure that the head arms is mounted on the telescopic bracket ④ in the first threaded hole and you are not able to see the remaining threaded holes. For the foot arms make sure the telescopic bracket ⑤, is mounted on the third hole and you are able to see 2 threaded holes.

4.

IMPORTANT!

 Before usage, adjust, with the patient weight into account, the position of the four arms for optimal lifting support. Ensure that the four arms still go in a horizontal position in flat mode.

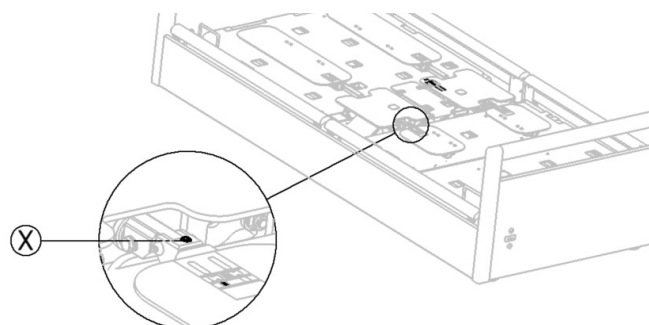

To adjust the position of the arms, fold them up at the joints to the main module and adjust screw ⑥ until the arms are in a horizontal position when folded back down.

5.

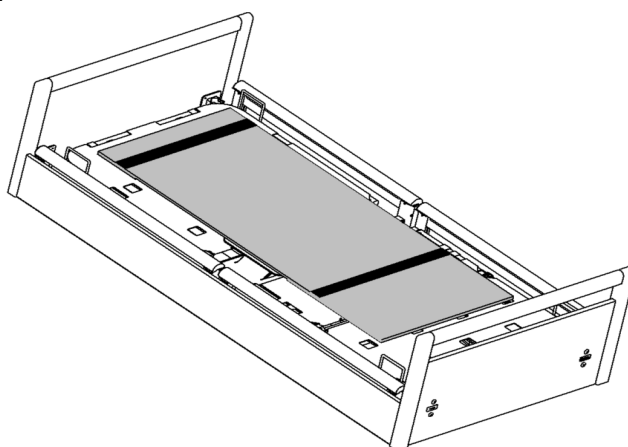

Mount the cover by sliding the pockets over the head end and foot end arms. The head end of the cover contains the label information and placement of the cover symbol:



Symbol indicating the head end of the cover.

! IMPORTANT!
The Careturner must not be used without the cover.

6. Place and secure the mattress onto the Careturner.
 - a. Release the Velcro fastener of both straps on the side of the cover and fold them away to the side.
 - b. Place the mattress onto the bed on top of the Careturner (for compatible mattresses see 9 *Technical Data*, page 21).
 - c. Guide the straps over the mattress and refix the Velcro fastener to tightly secure the mattress to the Careturner.

4 Usage

4.1 General safety information



WARNING!

Risk of personal injury and damage to property.

- The bed must be placed so that the height adjustment is not obstructed by, for example, lifts or furniture.
- Take care that no body parts are being squeezed between fixed parts (such as side rails, bed ends etc) and moving parts.
- The hand control must not be used by children.
- The hand control must only be used by care giver.



IMPORTANT!

If a power failure occurs, the battery secures the possibility of resetting the Careturner via the "ON/OFF" function.

- Make sure the battery is fully charged before using the Careturner.
- Refer to Battery in the Maintenance section for further information.

4.2 Overview

The Careturner can be operated either in manual or automatic mode.

In both modes it is possible to activate the normal functions of the bed.



It is recommend to have the head section slightly raised, while using the Careturner, to provide a more comfortable position to the end-user.

Manual mode

The manual mode has been designed to support the care staff in turning the end-user from side to side in the bed.

The wings can be raised and lowered via the hand control (see section *Manual Operation*).

Automatic mode

The automatic mode has been designed to provide pressure reduction to end-users.

In the AUTO program, the wings will move automatically according to pre-defined parameters for time and angle (see section *Auto Program Sequence*).

In Program 1 and 2, the wings will move automatically according to individually defined parameters for time and angle (see chapter *Programming*).

4.3 Control Box and Hand Control

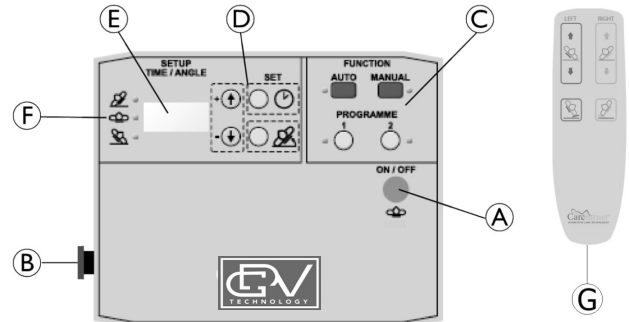

- (A) On/Off and Reset function button
- (B) Emergency stop button
- (C) Function buttons to choose the mode of operation.
- (D) Setup buttons to set the parameters for program 1 and 2
- (E) Display
- (F) Position indicators
- (G) Hand control

4.4 On/Off and Reset function

Turn the system on

1. Press and hold the button (A) for 3 sec. to turn the system on.

Reset function

The Reset function overrides all commands and moves both wings into a horizontal position.

1. To activate the Reset function press button (A) (without holding).

Turn the system off

1. Press the button (A) to reset the system and if applicable, wait until both wings moved into horizontal position.
2. Press and hold the button (A) for 3 sec. to turn the system off.

Display

System Status	Display	Note
OFF		Display blank
ON	Software version (3 digit number)	Displayed 2 sec. after system has been turned on (switches to passive mode if no function is selected).
ON	---	Passive mode (no function selected)
Reset	OFF	Displayed after the Reset function has been activated. The system subsequently switches to passive mode.

4.5 Emergency Stop

! IMPORTANT!

When the emergency stop is activated, the Reset function can still be activated, by pressing button (A), to lower the wings to horizontal position if required.

When the emergency stop is activated it stops all controls and movements immediately (wings will stay in current position).

1. To activate, push the button (B).
2. To deactivate, rotate the button (B) clockwise.
3. Press button (A) to reset the system.

4.6 Manual operation



WARNING!

Risk of squeezing and injury

If both wings are simultaneously elevated to angles of more than 12° there is a risk of squeezing the patient.

- This option must only be used by trained personnel.



The first time MANUAL is activated, after the system has been switched on, it will reset itself before the function can be used.

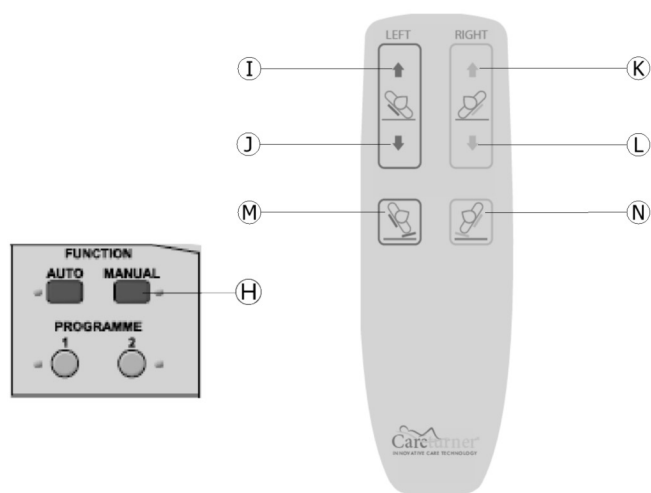

1. Press and hold button (H) for 3 sec. to activate manual operation.
2. Press buttons on hand control as required.
 - To raise the left wing, press (I)
 - To lower the left wing, press (J)
 - To raise the right wing, press (K)
 - To lower the right wing, press (L)
 - To raise right wing from 0° to 70° and left wing from 0° to 5°, press (M)
 - To raise left wing from 0° to 70° and right wing from 0° to 5°, press (N)



- Left and right buttons can be activated at the same time to move both wings simultaneously. The wings can be moved in a range from 0° to 70°.

3. To deactivate manual operation, press the ON/OFF button (A).

Display	LED	Note
0 = no activity U01 = right wing moves up d01 = right wing moves down U01 = left wing moves up d01 = left wing moves down	MANUAL LED active	The numbers on the display represent the angle at which the wing is positioned, while the letters represent the direction of movement: - U = up movement. - d = down movement. - 01 = 1°

4.6.1 Recommended Procedures

Transfer from flat position to the side:

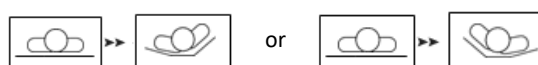

Press either (N) or (M) depending on which side the patient should be elevated to.

Transfer from one side to the other:

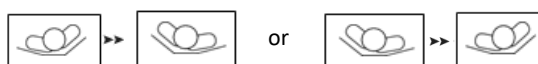

1. If left side is elevated - press and hold (M) to transfer from left to right side. Release button when desired height is maintained.
2. If right side is elevated - press and hold (N) to transfer from right to left side. Release button when desired height is maintained.

4.7 Automatic operation

The AUTO program is pre-defined and can not be changed.

Program 1 and 2 can be individually defined by the care staff (see chapter *Programming*). Upon delivery the programs are empty and need to be defined before usage.



- If one of the programs is activated, the system will reset to FLAT position before starting the selected program.
- If a new program is selected while another program is active, the system will reset to FLAT position before starting the new program.

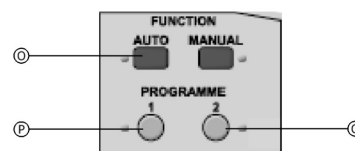

1. Press program buttons as required.
 - To start the AUTO Program, press and hold (Q) for 3 sec.
 - To start Program 1, press and hold (P) for 3 sec.
 - To start Program 2, press and hold (R) for 3 sec.

2. To stop a running program press the ON/OFF (A) button.

 The hand control will not work when a program is active.

Status indicators

Active Program	Display	LED	Note
AUTO	AU	AUTO LED active	
Program 1	P1	P1 LED active	
Program 2	P2	P2 LED active	
Timer	P1/XX and P2/XX		The display changes between the selected program and the time to the next reposition. -P1/01 = program 1 and 01 minute before next reposition. -P2/05= program 2 and 05 minutes before next reposition.

4.7.1 Auto program sequence

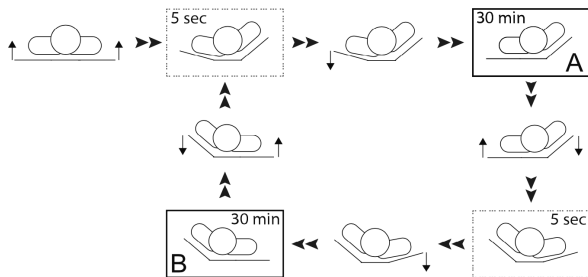

- Starting from the flat position, both wings immediately begin to raise simultaneously.
- Left wing stops at 12° and the right wing stops at 40°.
- 5 seconds after the right wing has reached 40° the left wing lowers to 0°.
- This position A is maintained for 30 minutes.
- Simultaneously the left wing begins to raise and the right wing begins to lower.
- The right wing stops at 12° and the left wing continue to raise up to 40°.
- 5 seconds after the left wing has reached 40° the right wing lowers to 0°.
- This position B is kept for 30 minutes.

The cycle will continue shifting between position A and B, until the program is stopped.

4.7.2 Pause automatic operation

 It is possible to pause an automatic operation and use the hand control as in manual mode.

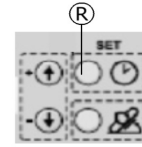

1. Press and hold for 3 sec. (R) button, while an automatic program is running, the wings will move to the flat position. Now the manual mode can be used.
2. The activated program before the pause action, will proceed after 30 minutes of inactivity, 10 sec before the program starts a BEEP is heard, if the inactivity period should be extended press any button on the hand control after the BEEP.
3. If the automatic program should start again right away, press and hold (R) for 3 sec to activate.

4.8. Charging the battery

The battery is charging when the system is connected to the power supply and turned on.

Charging of the battery is indicated by a dot in the bottom right corner of the display.

The battery will be fully charged after 12 hours.

 The battery is NOT charging when error E03 or E04 occurs.

4.9 Emergency release of the wing

In case of a power or motor failure, an emergency release of the wing could be necessary.



CAUTION !

Risk of injury

- A minimum of two persons is required for an emergency release of the wing.
- When releasing the wing it might lower fast. Keep clear the area under the wing and arms.



IMPORTANT!

- Before an emergency release of the wing, remove the plug from the mains socket.

1. Both persons hold the elevated wing.
2. One of them locates the motor pin in question and pulls out the safety pin.

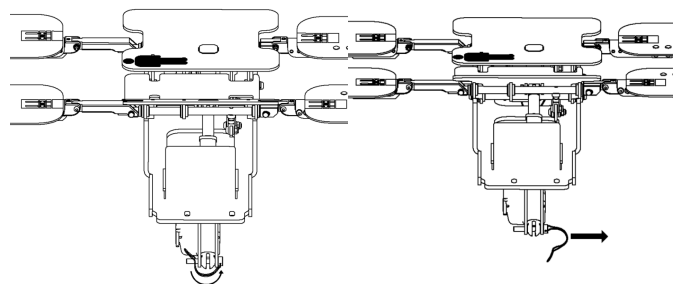

3. After the pin is removed, the motor will fall out of the support and slowly lower the wing.

5 Programming

5.1 Individually defined programs

Program 1 and 2 can be individually defined by the care staff by setting the angles of the wings and the times for holding the different positions.

Defining angles

The angles of the left and right wing in the first side position can be defined individually. The second (opposite) side position will automatically be defined as a mirror image of the first side position.

- If the angle for one wing is set between 13°–40°, this wing will be defined as the “primary wing.”
- The opposite wing will then be defined as the “secondary wing” and limits its selectable angle values to 0°–12°.
- The “primary wing” defines the first side position in the program sequence.

Two options for the wing the end-user is laying on (e.g. left wing if the end-user is laying on the left side):

- If the angle of the secondary wing is set to 0° it will be elevated by 12° during the turn movement and move to a horizontal position 5 sec. after the primary wing has reached its set angle, so the end-user will rest on a flat secondary wing.
- If the angle value for the secondary wing is set between 1°–12° it will stay elevated at the selected angle in a side position and the end-user will rest on a elevated secondary wing.



WARNING!

Risk of falling

If the secondary wing stays elevated while the end-user is resting in a side position, the distance to the top of the side rail is decreased.

- Only use the side rails listed for this situation in 9 *Technical Data*, page 21.

Defining the time:

The times for the two side positions and the flat position can be defined individually between 000 and 180 minutes.



It is possible to select if flat position, left or right side should start right away.

If the time for one side position is set to 000 minutes:

- the program will start to transition from the flat position into the first position after the specified time.
- the program will only cycle between the flat and the other side position (e.g. flat-right-flat-right-...)

If the time for the flat position is set to 000 minutes:

- the program will start immediately after activation with the transition to the first side position.
- the program will only cycle between the two side position (e.g. left-right-left-right-...).

If the time value for the flat position is set between 3–180 minutes:

- the program will start to transition from the flat position into the first position after the specified time.
- the program will always move into a flat position between the two side positions (e.g. flat-right-flat-left-flat-right-...)



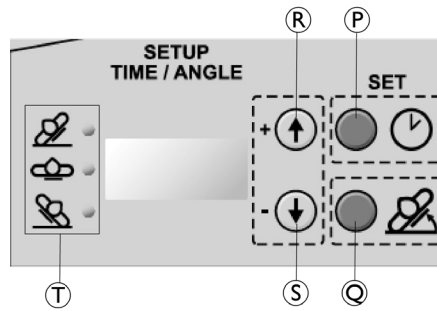

























5.2 How to program the individual automated programs



- P Set time / Start programming mode button
- Q Set angle button
- R Adjust button Plus (increase values for time and angle)
- S Adjust button Minus (decrease values for time and angle))
- T Position indicators (LEDs)
 - Right (top) = right wing or position
 - Flat (middle) = both wings in horizontal position
 - Left (bottom) = Left wing or position

When programming the Careturner, first the time period for which the wings are in a elevated or flat position is set, second the angles at which to elevate and third the starting side of the wings (right, left or flat).This is done for either Program 1 or Program 2.

Step	Function	Display	LED	Note	
1	Press and hold for 3 sec.		SEL	None	Start the programming mode
2	Press		P1	P1	Choose the program to be set
	or		P2	P2	
3	Press		010	P1 or P2 & Right 	The time value appears in the display
4	Press		001	P1 or P2 & Right 	Adjust the time between 000 and 180 minutes (0, 3, 10-180 in +/- 10 min. intervals)
			020		
5	Press		010	P1 or P2 & Flat 	The time value appears in the display
6	Press		001	P1 or P2 & Flat 	Adjust the time between 000 and 180 minutes (0, 3, 10-180 in +/- 10 min. intervals)
			020		

Step	Function	Display	LED	Note
7	Press  	010	P1 or P2 & Left 	The time value appears in the display
8	Press  	001 020	P1 or P2 & Left 	Adjust the time between 000 and 180 minutes (0, 3, 10-180 in +/- 10 min. intervals)
9	Press  	A	None	single *BEEP* = The time has now been set.
10	Press  	015	P1 or P2 & Right 	The angle value appears in the display
11	Press  	014 016	P1 or P2 & Right 	Adjust the angle between 00 and 40 degrees (+/- 1 degree interval)
12	Press  	010	P1 or P2 & Left 	The angle value appears in the display
13	Press  	009 011	P1 or P2 & Left 	Adjust the angle between 00 and 40 degrees (+/- 1 degree interval)
14	Press  	-	None	double *BEEP* = The angle has now been set.
15	Press  	SEL	Right  Flat  Left 	Adjust which side the Careturner will start, RIGHT, FLAT or LEFT.
16	Press  	-	None	triple *BEEP* = The starting side has been chosen and the entire program is saved.



- The programming mode will automatically be closed down without saving, if no buttons are pressed for 2 min.

5.3 Program examples for automated pressure relief

- End-user turning from right side to flat to left side and always laying on a flat wing.
 - Angle primary wing = 13°-40°
 - Angle secondary wing = 0°
 - Time for right, flat and left position > 0 min.
- End-user turning from right to flat to left side and always laying on a slightly elevated wing.
 - Angle primary wing = 13°-40°
 - Angle secondary wing = 1°-12°
 - Time for right, flat and left position > 0 min.

This Program requires “high” side rails.

- End user turning from right to left side, never laying in a flat position and always laying on a flat wing.
 - Angle primary wing = 13°-40°
 - Angle secondary wing = 0°
 - Time flat position = 0 min.
 - Time left and right position > 0 min.
 - see section *Auto program sequence* as an example.
- End user turning from right to left side, never laying in a flat position and always laying on a slightly elevated wing (Cradle function).
 - Angle primary wing = 13°-40°
 - Angle secondary wing = 1°-12°
 - Time flat position = 0 min.
 - Time left and right position > 0 min.

This Program requires “high” side rails.

- End user turning from one side to flat and back to the same side, always laying on a flat wing.
 - Angle primary wing = 13°-40°
 - Angle secondary wing = 0°
 - Time flat position > 0 min.
 - Time left or right side position = 0 min.

- End user turning from one side to flat and back to the same side, always laying on a slightly elevated wing.
 - Angle primary wing = 13°-40°
 - Angle secondary wing = 1°-12°
 - Time flat position > 0 min.
 - Time left or right side position = 0 min.

This Program requires “high” side rails.

- Both wings raised to equal angles without repositioning (Backward hug).
 - Angle primary and secondary wing = 10°-12°
 - Time flat position = 0 min.
 - Time left and right position > 0 min (set values not relevant, see below)



No automatic repositioning will occur when both wings are set to same angle and therefore, the times set for left or right side position do not have any influence.

6 Maintenance

6.1 General Maintenance Information



IMPORTANT!

Service and maintenance of the Careturner must be carried out together with the bed.

- For detailed information on maintenance procedures and checklists see *User Manual and/ or Service Manual* for the bed in use.

6.2 Cleaning and disinfection



CAUTION!

Risk of contamination

- Take precautions for yourself and use appropriate protective equipment.



IMPORTANT!

Wrong fluids or methods can harm or damage your product.

- All cleaning agents and disinfectants used must be effective, compatible with one another and must protect the materials they are used to clean.
- Never use corrosive fluids (alkalines, acid, cellulose thinner, acetone etc). We recommend an ordinary household cleaning agent such as dishwashing liquid, if not specified otherwise in the cleaning instructions.
- Never use a solvent that changes the structure of the plastic or dissolves the attached labels.
- Always make sure that the product is completely dried before taking into use again.

Electrical components



IMPORTANT!

The IP classification determines the washability of the electrical components.

Electronics classified IPx6 may NOT be washed with jet based cleaning equipment or in a washing tunnel.

Electronics classified IP66 may be washed with a jet based cleaning equipment but NOT in a washing tunnel.

- The IP classification is stated on the serial labels of the electrical components.
- Please also note that the components can have different classification.
- The lowest IP classification decides the overall classification of the combination.

Textiles

See attached label on the textile cover for detailed washing instructions.

Ensure that the foam support from foot end of the cover is taken out, before placing the cover in a washing machine.

General Cleaning Method

Method: Wipe off with a wet cloth or soft brush.

Max temp: 40 °C

Solvent/chemicals: Mild household detergent or soap and water.



IMPORTANT!

For detailed information of cleaning methods see instructions in the user manual of the bed in use.

Cleaning Intervals



IMPORTANT!

Regular cleaning and disinfection enhances smooth operation, increases the service life and prevents contamination.

Clean and disinfect the product

- before and after any service procedure,
- when it has been in contact with any body fluids,
- before using it for a new user.

6.3 Battery

We recommend a check of the battery every 6 months:

1. Elevate both wings and unplug the power cable.
2. Press ON/OFF button  and ensure both wings move into horizontal position.

We recommend replacement of the battery after 4 years – Call dealer/technician to replace battery.

Storage



IMPORTANT!

Before storage of the Careturner, ensure the system has been turned off completely and the emergency stop button is pressed to prevent the battery from discharging.

7 After Use

7.1 Disposal

**WARNING!****Environmental Hazard**

Device contains batteries.

This product may contain substances that could be harmful to the environment if disposed of in places (landfills) that are not appropriate according to legislation.

- DO NOT dispose of batteries in normal household waste.
- Batteries MUST be taken to a proper disposal site. The return is required by law and free of charge.
- Do only dispose discharged batteries.
- For information on the battery type see battery label or chapter 9 *Technical Data*, page 22.

Be environmentally responsible and recycle this product through your recycling facility at its end of life.

Disassemble the product and its components, so the different materials can be separated and recycled individually.

The disposal and recycling of used products and packaging must comply with the laws and regulations for waste handling in each country. Contact your local waste management company for information.

We only use REACH compliant materials and components.

- All electric parts must be dismantled and be disposed of as electric components.
- Plastic parts must be sent for incineration or recycling.
- Steel parts must be disposed of as waste metals.

7.2 Reconditioning

This product is suitable for reuse. To recondition the product for a new user, carry out the following actions:

- Inspection, cleaning and disinfection as described in chapter 6 *Maintenance*, page 17.

8 Troubleshooting

8.1 Troubleshooting the electrical system

Error	Display (flashes at 0.5 sec. intervals between two codes)		Acoustic Signal	LED (flashes yellow)	Comment	Solution
Stoppage on motor LEFT Overload on motor LEFT	E01	E0	10 beeps with 1 sec. ON and 1 sec. OFF When trying to activate motor again: 1 beep for 1 sec.	Left	only in Auto mode (no display, acoustic signal and flashing LED in manual mode)	Check the cables to and from the motor for the following: - Cable undamaged. - Cable correctly connected to motor. - Cable connector correctly installed and intact.
Stoppage on motor RIGHT Overload on motor RIGHT	E02	E0		Right		
Battery mode: Power failure OR Emergency stop activated	E03	E0	4 beeps with 1 sec. ON and 1 sec. OFF		<ul style="list-style-type: none"> - 1st acoustic signal when disconnected from power supply OR the emergency stop is activated. The system switches to battery mode and the wings will stop moving and stay in current position. - 2nd acoustic signal after 20 min. - 3rd acoustic signal after 40 min. - After 60 min the system switches to low battery error (E04). 	Connect to power supply AND / OR deactivate the emergency stop to charge and check the battery (refer to chapter Maintenance for further information).
Low battery	E04	E0	4 beeps with 1 sec. ON and 1 sec. OFF		<ul style="list-style-type: none"> - 1st acoustic signal when the battery is detected to be low while in battery mode. - Further acoustic signals occur every 20 min until the system turns off to save battery power for one CPR lowering. 	
System can not be turned on					Although the system is connected to power supply it can not be turned on.	Check if the emergency stop is activated and deactivate if necessary.



Press the ON/OFF button to reset an ERROR and try again.

Contact your dealer or GDV representative if the above does not solve your problems.

8.2 Programming Errors

Error display for incorrect setup of values for Program 1 or 2



Error	Display	Acoustic Signal	Comment
Program 1 or 2	E40 for 4 sec.	2 beeps of 5 sec. ON and 1 sec. OFF	Occurs when activating Program 1 or 2 with incorrect time values set. The following combination of time values for the left, right and flat position are defined as incorrect setup: <ul style="list-style-type: none"> - All three time values = 0 min - Only one time value > 0 min / two time values = 0 min - If you select one side to 0 min and chose the same side to start.

9 Technical Data

9.1 Characteristics

Automatic Operation	yes
Max. angle in Manual mode	70°
Max. angle in Automatic mode	primary wing = 40° secondary wing = 12°
Angle values in Automatic mode	0°–40° (+/- 1° interval)
Time values in Automatic mode	0, 3, 10–180 min (+/- 10 min intervals)

9.2 Weights

	Max. user weight (provided that the weight of the mattress does not exceed 20 kg)	165 kg
	Max. safe working load weight (including mattress)	185 kg

Weights of Careturner components

Complete (main module and 4 arms)	31.6 kg
Head arm (1 piece)	3.7 kg
Foot arm (1 piece)	1.9 kg
Main module	23.5 kg
Control Box	2.5 kg

9.3 Allowed mattress sizes

Mattress height and side rail compatibility



IMPORTANT!

Depending if the end-user in a side position is laying on a flat wing (mattress horizontal) OR if the wing the end-user is laying on is raised up to 12°, different combinations of mattresses and side rails are required (see appropriate chart below).

- End-user laying on flat wing

Allowed mattress heights, when the end-user is laying on a flat wing (secondary wing = 0°).

Side rail	Mattress height
Highest position / full protection	12–14 cm
With side rail height extender mounted*	15–20 cm

*Must be dismantled when the side rail is collapsed and the end-user is getting out of the bed.

- End-user laying on a elevated wing

Allowed mattress heights, when the end-user is laying on a up to 12° elevated wing (secondary wing = 1–12°).

Side rail	Mattress height
Highest position / full protection	12 cm
With side rail height extender mounted*	13–18 cm

*Must be dismantled when the side rail is collapsed and the end-user is getting out of the bed.

Mattress width and length depending on bed width

Bed width	Allowed mattress width	Min. length (cm)
90 cm	88–90 cm	200 cm



A castellated mattress is recommended.



9.4 Environmental conditions



	Storage and transportation	Operation
Temperature	-10°C to +50°C	+5°C to +40°C
Relative humidity	20% to 75%	
Atmospheric pressure	800 hPa to 1060 hPa	



Be aware that when a bed has been stored under low temperatures, it must be adjusted to operating conditions before use.

9.5 Electrical system

Voltage supply: Uin 230 Voltage, AC, 50/60 Hz (AC = Alternating current)
Maximum current input: Iin max.1,5 Ampere
Intermittent (periodic motor operation): Int = Max. 10 %, 2 min ON / 18 min OFF
Insulation class: CLASS II

Type B Applied Part

Applied Part complying with the specified requirements for protection against electrical shock according to IEC60601-1.
(An applied parts is a part of the medical equipment which is designed to come into physical contact with the patient or parts that are likely to be brought into contact with the patient.)

Battery type: LP 12-0.8 (12 V 0.8AH) Sealed Lead-acid Battery	
 Pb	
Constant voltage charge:	
<ul style="list-style-type: none"> • Standby use: 13.5-13.8 V • Cycle use: 14.4-15.0 V • Initial current: Less than 0.24 A 	
Sound level: 58.5 dB (A)	
Degree of protection: IPx6* or IP66**	
The main module, actuators and hand control are protected according to IPx6. The Control box is protected according to IP66	

* IPX6 classification means that the electrical system is protected against water projected from any direction (not high pressure).

** IP66 classification means that the electrical system is protected against high-pressure water jets projected from any direction and fully protected against dust and other particulates, including a vacuum seal.

10 Electromagnetic compatibility (EMC)

10.1 General EMC information

Medical Electrical Equipment needs to be installed and used according to the EMC information in this manual.

This product has been tested and found to comply with EMC limits specified by IEC/EN 60601-1-2 for Class B equipment.

Portable and mobile RF communications equipment can affect the operation of this product.

Other devices may experience interference from even the low levels of electromagnetic emissions permitted by the above standard. To determine if the emission from this product is causing the interference, run and stop running this product. If the interference with the other device operation stops, then this product is causing the interference. In such rare cases, interference may be reduced or corrected by the following:

- Reposition, relocate, or increase the separation between the devices.

10.2 Electromagnetic emission

Guidance and manufacturer's declaration

This product is intended for use in the electromagnetic environment specified below. The customer or the user of this product should assure that it is used in such an environment.

Emissions test	Compliance	Electromagnetic environment – guidance
RF emissions CISPR 114	Group I	This product uses RF energy only for its internal function. Therefore, its RF emissions are very low and are not likely to cause any interference in nearby electronic equipment.
RF emissions CISPR 114	Class B	This product is suitable for use in all establishments including domestic establishments and those directly connected to the public low-voltage power supply network that supplies buildings used for domestic purposes.
Harmonic emissions IEC 61000-3-2	Class A	
Voltage fluctuations / flicker emissions IEC 61000-3-3	Complies	

10.3 Electromagnetic Immunity

Guidance and manufacturer's declaration

This product is intended for use in the electromagnetic environment specified below. The customer or the user of this product should assure that it is used in such an environment.

Immunity test	Test / Compliance level	Electromagnetic environment – guidance
Electrostatic discharge (ESD) IEC 61000-4-2	± 8kV contact ± 2 kV, ± 4 kV, ± 8 kV, 15 kV air	Floors should be wood, concrete or ceramic tile. If floors are covered with synthetic material, the relative humidity should be at least 30 %.
Electrostatic transient / burst IEC 61000-4-4	± 2 kV for power supply lines; 100 kHz repetition frequency ± 1 kV for input / output lines; 100 kHz repetition frequency	Mains power quality should be that of a typical commercial or hospital environment.
Surge IEC 61000-4-5	± 1 kV line to line ± 2 kV line to earth	Mains power quality should be that of a typical commercial or hospital environment.

Immunity test	Test / Compliance level	Electromagnetic environment – guidance
Voltage dips, short interruptions and voltage variations on power supply input lines IEC 61000-4-11	< 0% U _T for 0,5 cycle at 45° steps 0% U _T for 1 cycles 70% U _T for 25 / 30 cycles < 5% U _T for 250 / 300 cycles	Mains power quality should be that of a typical commercial or hospital environment. If the user of this product requires continued operation during power mains interruptions, it is recommended that the product is powered from an un-interruptible power supply or a battery. U _T is the a. c. mains voltage prior to application of the test level.
Power frequency (50/60 Hz) magnetic field IEC 61000-4-8	30 A/m	Power frequency magnetic fields should be at levels characteristic of a typical location in a typical commercial or hospital environment.
Conducted RF IEC 61000-4-6	3V 150 kHz to 80 Mhz 6V in ISM & amateur radio bands 10 V/m 80 Mhz to 2,7 GHz	Field strengths from fixed transmitters, such as base stations for radio (cellular/cordless) telephones and land mobile radios, amateur radio, AM and FM radio broadcast and TV broadcast cannot be predicted theoretically with accuracy. To assess the electromagnetic environment due to fixed RF transmitters, an electromagnetic site survey should be considered. If the measured field strength in the location in which this product is used exceeds the applicable RF compliance level above, this product should be observed to verify normal operation. If abnormal performance is observed, additional measures may be necessary, such as reorienting or relocating this product. Interference may occur in the vicinity of equipment marked with the following symbol: 
Radiated RF IEC 61000-4-3	385 MHz - 5785 MHz test specifications for immunity to RF wireless communication equipment refer to table 9 of IEC 60601-1-2:2014	Portable and mobile RF communications equipment should be used no closer than 30 cm to any part of this product including cables.

 These guidelines may not apply in all situations. Electromagnetic propagation is affected by absorption and reflection from structures, objects and people.

10. 3.1 Test specifications for immunity to RF wireless communications equipment

IEC 60601-1-2:2014 — Table 9

Test Frequency (MHz)	Band ^{a)} (MHz)	Service ^{a)}	Modulation ^{b)}	Maximum power (W)	Distance (m)	Immunity test level (V/m)
385	380 - 390	TETRA 400	Pulse modulation ^{b)} 18 Hz	1.8	0.3	27
450	430 - 470	GMRS 460, FRS 460	FM ^{c)} ± 5 kHz deviation 1 kHz sine	2	0.3	28
710 745 780	704 - 780	LTE Band 13,17	Pulse modulation ^{b)} 217 Hz	0.2	0.3	9
810 870 930	800 - 960	GSM 800/900, TETRA 800, iDEN 820, CDMA 850, LTE Band 5	Pulse modulation ^{b)} 18 Hz	2	0.3	28

Test Frequency (MHz)	Band ^{a)} (MHz)	Service ^{a)}	Modulation ^{b)}	Maximum power (W)	Distance (m)	Immunity test level (V/m)
1720 1845 1970	1700 - 1990	GSM 1800; CDMA 1900; GSM 1900; DECT; LTE Band 1, 3, 4, 25; UMTS	Pulse modulation ^{b)} 217 Hz	2	0.3	28
2450	2400 - 2570	Bluetooth, WLAN, 802.11 b/g/n, RFID 2450, LTE Band 7	Pulse modulation ^{b)} 217 Hz	2	0.3	28
5240 5500 5785	5100 - 5800	WLAN 802.11 a/n	Pulse modulation ^{b)} 217 Hz	0.2	0.3	9



If necessary to achieve the immunity test level, the distance between the transmitting antenna and the Medical Electrical Equipment or System may be reduced to 1 m. The 1 m test distance is permitted by IEC 61000-4-3.

a) For some services, only the uplink frequencies are included.

b) The carrier shall be modulated using a 50 % duty cycle square wave signal.

c) As an alternative to FM modulation, 50 % pulse modulation at 18 Hz may be used because while it does not represent actual modulation, it would be worst case.



GDV Technology A/S
Værkstedsgården 15, st. th.
2620 Albertslund
Denmark

GDVMAWBO220620 2020-06-01



www.careturner.com
info@gdvtech.com

