

## MULTICARE X

Bed for critical care

Quick reference guide does not replace the valid user manual for Multicare X!

### BED DESCRIPTION

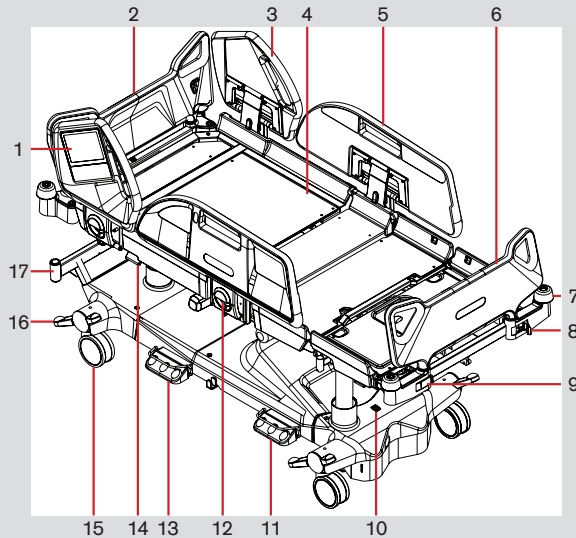

- |   |                                    |
|---|------------------------------------|
| 1. Multiboard X   | 9. Foot Board Safety Lock (locked) |
| 2. Removable Head Board                                       | 10. i-Drive Power mains switch     |
| 3. Head Siderail  | 11. Bed Height Foot Control        |
| 4. Four-part Mattress support platform with Ergoframe® System | 12. Siderail Release Lever         |
| 5. Foot Siderail with Patient Control Panels                  | 13. Lateral Tilt Foot Control      |
| 6. Removable Foot Board (lockable)                            | 14. CPR Lever – Backrest Release   |
| 7. Corner Bumper  | 15. Castor                         |
| 8. Foot Board Safety Lock (unlocked)                          | 16. Castor Control Lever           |
|   | 17. Accessory Adaptor              |

### MULTIBOARD (KEYBOARD)

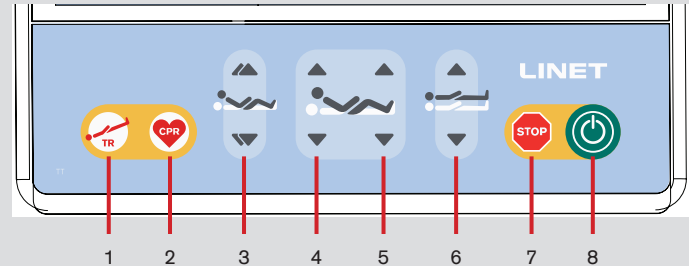

1. Emergency Trendelenburg Position Button
2. CPR (Resuscitation) Position Button
3. Autocontour Adjustment Buttons (simultaneous movement of the Backrest and Thighrest)
4. Backrest Adjustment Buttons
5. Thighrest Adjustment Buttons
6. Bed Height Adjustment Buttons
7. Central STOP Button (press to interrupt bed positioning)
8. GO Button (press to activate control elements)

## MULTICARE X

D9R001MCX-0110\_02

Bed for critical care

Quick reference guide does not replace the valid user manual for Multicare X!

### ATTENDANT CONTROL PANEL

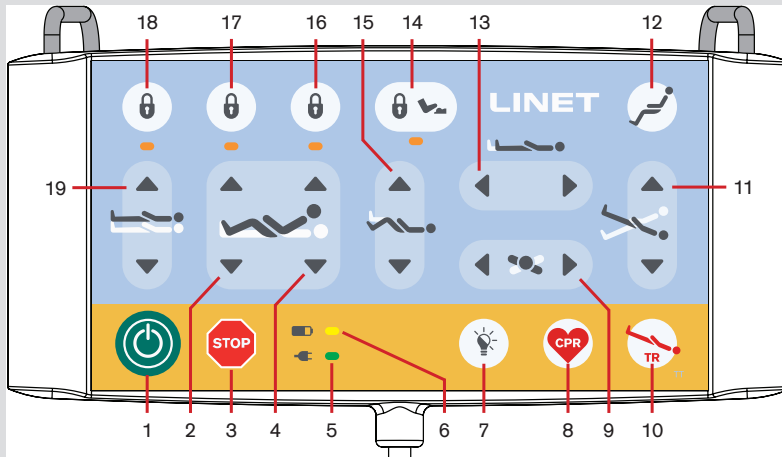

- |   |   |
|---|---|
| <ol style="list-style-type: none"> <li>1. GO Button</li> <li>2. Thighrest Adjustment Buttons</li> <li>3. Central STOP Button</li> <li>4. Backrest Adjustment Buttons</li> <li>5. Mains Power LED</li> <li>6. Accumulator Charge Status LED</li> <li>7. Illumination Control Button</li> <li>8. CPR Position Button</li> <li>9. Lateral Tilt Buttons</li> <li>10. Emergency Trendelenburg Position Button</li> </ol> | <ol style="list-style-type: none"> <li>11. Longitudinal Tilt Buttons</li> <li>12. Cardiac Chair Position Button</li> <li>13. Bed Extension Adjustment Buttons</li> <li>14. Foot Control Lock Button and LED</li> <li>15. Calfrest Adjustment Buttons</li> <li>16. Backrest Lock Button and LED</li> <li>17. Thighrest, Calfrest and Bed Extension Adjustment Lock Button and LED</li> <li>18. Bed Height, Lateral Tilt, Trendelenburg Tilt and Antitrendelenburg Tilt Lock Button and LED</li> <li>19. Bed Height Adjustment Buttons</li> </ol> |
|---|---|

### ENABLING OR DISABLING FUNCTIONS (ATTENDANT CONTROL PANEL)

1. Activate the keyboard by pressing the GO button (1).
  2. Press the respective lock button (14, 16, 17 or 18).
- Respective lock LED is illuminated when function is locked.
- Respective lock LED is no longer illuminated when function is unlocked.

### HANDSET

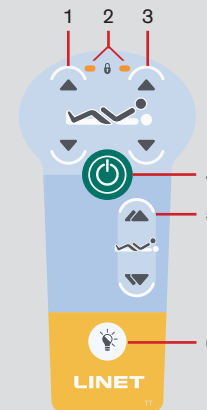

1. Thighrest Adjustment Buttons
2. Thighrest/Backrest Lock LED
3. Backrest Adjustment Buttons
4. GO Button
5. Autocontour Adjustment Buttons
6. Flashlight Button

## MULTICARE X

Bed for critical care

Quick reference guide does not replace the valid user manual for Multicare X!

### FOOT SIDERAIL CONTROL

### BED HEIGHT FOOT CONTROL

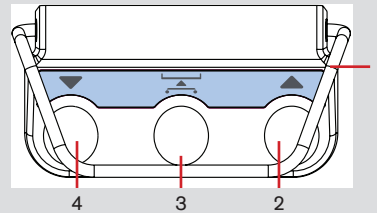
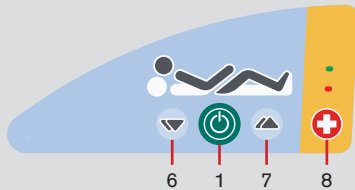

1. Protection Frame against Unwanted Activation
2. Raise Mattress support platform Pedal
3. Examination Position Pedal
4. Lower Mattress support platform Pedal

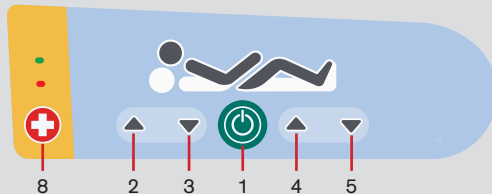

### LATERAL TILT FOOT CONTROL

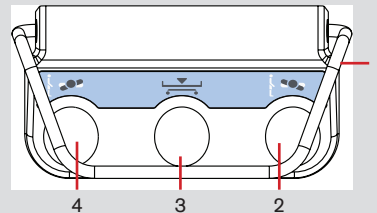

1. Protection Frame against Unwanted Activation
2. Tilt Right Pedal
3. Low Flat Position Pedal
4. Tilt Left Pedal

1. GO Button (activation of the control panel)
2. Backrest Adjustment Button – UP
3. Backrest Adjustment Button – DOWN
4. Thighrest Adjustment Button – UP
5. Thighrest Adjustment Button – DOWN
6. Autocontour Adjustment Button – (simultaneous movement of the Backrest and Thighrest) – DOWN
7. Autocontour Adjustment Button (simultaneous movement of the Backrest and Thighrest) – UP
8. Nurse Call Button

#### Press the selected pedal twice in 3 seconds:

- Bed Height Foot Control or Lateral Tilt Foot Control is activated for 30s after this procedure.

## MULTICARE X

D9R001MCX-0110\_02

Bed for critical care

Quick reference guide does not replace the valid user manual for Multicare X!

### MULTIBOARD (LCD) - HOME SCREEN

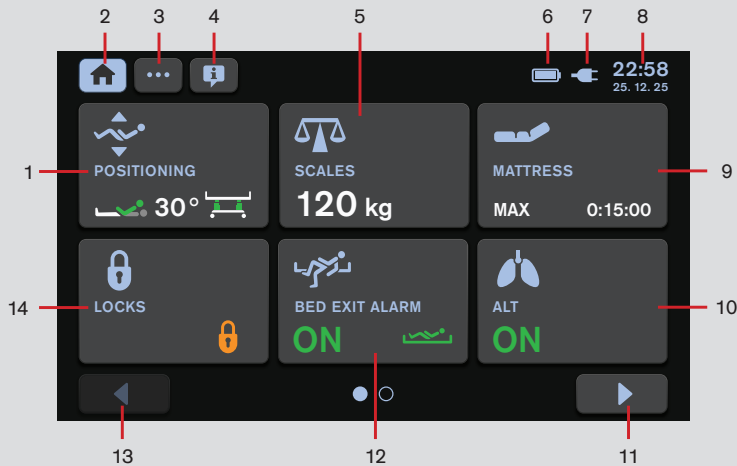

### POSITIONING SCREEN

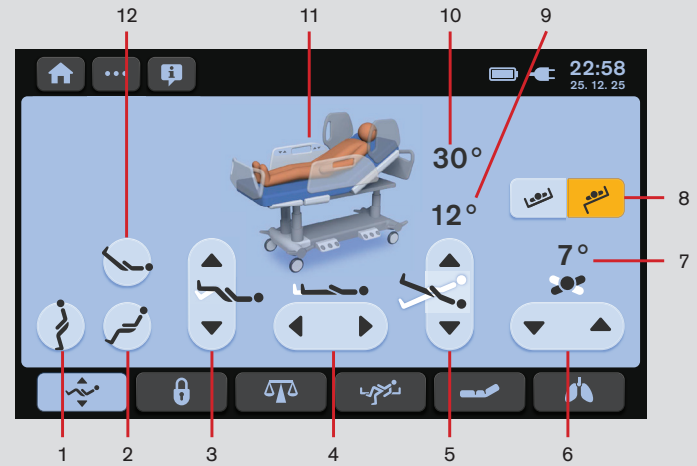

1. Positioning Screen Tile (press to enter Positioning Screen)
2. Home Screen Icon (press to enter Home Screen if another screen is selected)
3. Settings Screen Icon (press to enter Settings Menu of the selected screen)
4. Help Screen Icon (press to display bubbles with helpful descriptions on the selected screen)
5. Scales Screen Tile (press to enter Scales Screen)
6. Accumulator Charge Status Indicator
7. Connection to mains power Indicator
8. Time and Date Indicator

9. Intergrated Mattress Screen Tile (press to enter Integrated Mattress Screen)
10. ALT Screen Tile (press to enter Automatic Lateral Therapy Screen)
11. Next Page Icon (press to enter next page of the Home Screen if available)
12. Bed Exit Alarm Monitoring Screen Tile (press to enter Bed Exit Alarm Monitoring Screen)
13. Previous Page Icon (press to enter previous page of the Home Screen if available)
14. Lock Screen Tile

1. Mobilization Position Icon
2. Cardiac Chair Position Icon
3. Calfrest Adjustment Icons (UP/DOWN)
4. Bed Extension Icons (LONGER/SHORTER)
5. Longitudinal Tilt Icons (UP/DOWN)
6. Lateral Tilt Icons (UP/DOWN)
7. Lateral Tilt Angle Indicator
8. Transport Mode Icons (ON/OFF)
9. Trendelenburg/Antitrendelenburg Tilt Angle Indicator
10. Backrest Angle Indicator
11. Bed Status Indicator
12. Vascular Position Icon

## MULTICARE X

Bed for critical care

Quick reference guide does not replace the valid user manual for Multicare X!

### LOCK SCREEN

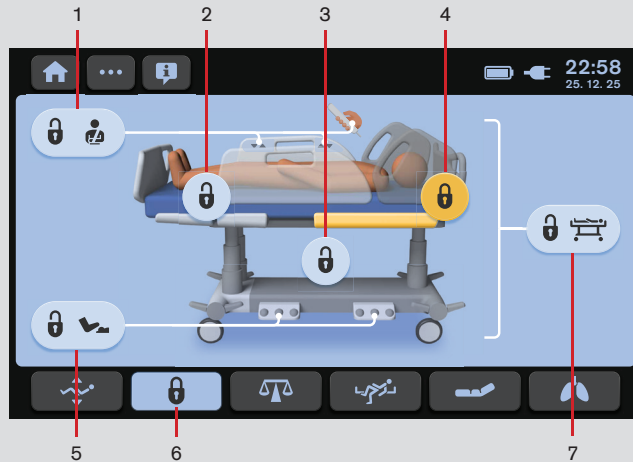

1. Patient Control Elements Lock Icon (Patient Control Panels in foot siderails, Handset, Mobi-Lift)
2. Thighrest and Calfrest Lock Icon
3. Height and Tilt Lock Icon (Bed Height, Trendelenburg Tilt, Antitrendelenburg Tilt, Lateral Tilt)
4. Backrest Lock Icon
5. Foot Control Lock Icon (Bed Height Foot Control, Lateral Tilt Foot Control)
6. Lock Screen Icon (blue background - activated, dark background - not activated)
7. Central Lock Icon (all Lock Icons are pressed/yellow if this icon is pressed)

### SCALES SCREEN

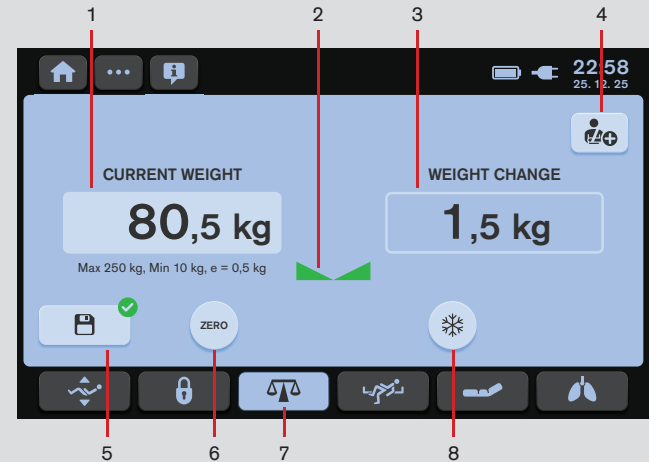

1. Primary display – Current Weight
2. Stabilized Scales Icon
3. Secondary display – Weight Change
4. NEW PATIENT Icon (press to enter NEW PATIENT Guide)
5. Memory Icon (save weight value)
6. ZERO Icon (press to enter Guide for Zeroing/Taring)
7. Scales Screen Icon
8. HOLD Icon (press to enter HOLD Mode Guide)

## MULTICARE X

D9R001MCX-0110\_02

Bed for critical care

Quick reference guide does not replace the valid user manual for Multicare X!

### BED EXIT ALARM MONITORING SCREEN

### AUTOMATIC LATERAL THERAPY - PROGRAMS

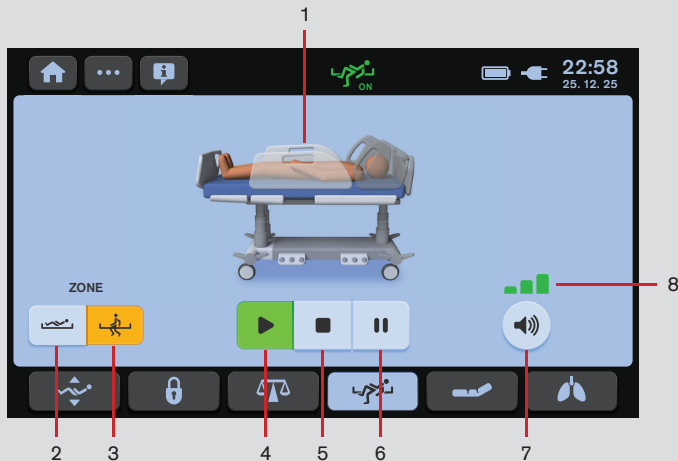

1. Bed Picture (Patient Picture is displayed when mattress support platform is loaded by more than 35 kg.)
2. Inner Zone Icon
3. Outer Zone Icon
4. ON Icon (activation)
5. OFF Icon (deactivation)
6. PAUSE Icon
7. VOLUME Icon
8. Indicator of 3 volume levels



1. Preset ALT Program Tile (ALT 1)
2. Preset ALT Program Tile (ALT 2)
3. Preset ALT Program Tile (ALT 3)
4. Preset ALT Program Tile (ALT 4)
5. ALT Screen Icon

#### To enter ALT Screen:

- Press ALT Screen Icon (5). Initial ALT Screen with 4 preset ALT programs appears on the LCD.

#### To select one Preset ALT Program:

- Press one of the 4 Preset ALT Program Tiles (1 or 2 or 3 or 4). ALT Screen with preset angles of the lateral tilt and preset periods during which mattress support platform occupies corresponding angles appears on the LCD.

## MULTICARE X

Bed for critical care

Quick reference guide does not replace the valid user manual for Multicare X!

### AUTOMATIC LATERAL THERAPY - SETTINGS

Values of periods and angles in the selected Preset ALT Program are changed when they are changed manually and saved in the selected Preset ALT Program.

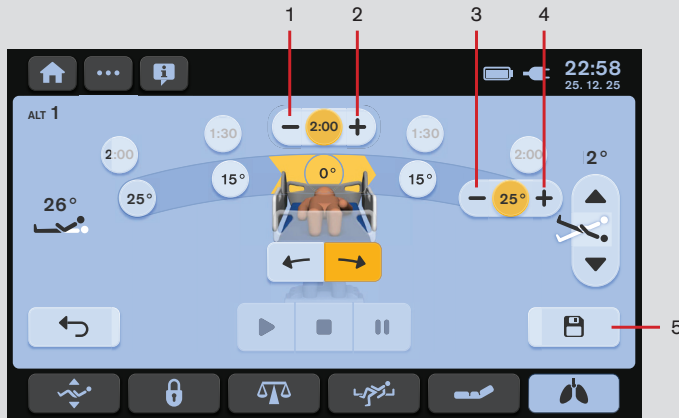

1. MINUS Icon (Period of Lateral Tilt Angle)
2. PLUS Icon (Period of Lateral Tilt Angle)
3. MINUS Icon (Lateral Tilt Angle Adjustment)
4. PLUS Icon (Lateral Tilt Angle Adjustment)
5. SAVE Icon (to save period settings and angles settings)

#### To adjust period for the Bed Position in corresponding Lateral Tilt Angle:

- Press selected Indicator of Period of Lateral Tilt Angle.
- Press MINUS Icon (1) or PLUS Icon (2).
- Press selected Indicator of Period of Lateral Tilt Angle once more or press another Indicator of Period of Lateral Tilt Angle. Selected Period of Lateral Tilt Angle is changed.
- Press SAVE Icon (5) to save the changed period settings before necessary TEST.

#### To adjust Lateral Tilt Angle:

- Press selected Indicator of Lateral Tilt Angle.
- Press MINUS Icon (3) or PLUS Icon (4).
- Press selected Indicator of Lateral Tilt Angle once more or press another Indicator of Lateral Tilt Angle. Selected Lateral Tilt Angle is changed.
- Press SAVE Icon (5) to save the changed angle settings before necessary TEST.

## MULTICARE X

D9R001MCX-0110\_02

Bed for critical care

Quick reference guide does not replace the valid user manual for Multicare X!

### RUNNING AUTOMATIC LATERAL THERAPY

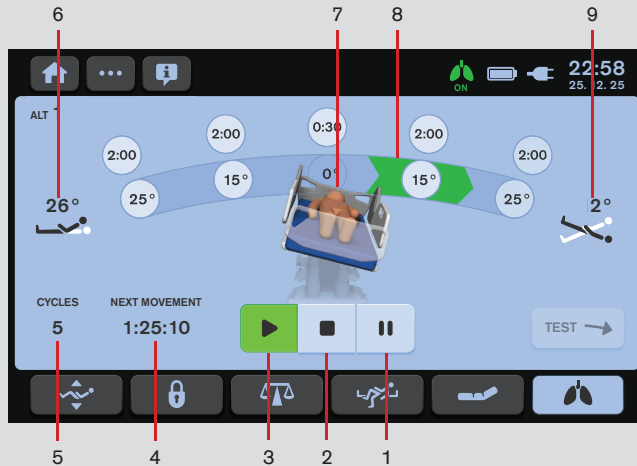

#### To start a set Automatic Lateral Therapy:

- Press PLAY Icon (3).

1. PAUSE Icon
2. STOP Icon (to stop a running Automatic Lateral Therapy)
3. PLAY Icon (to start a selected Automatic Lateral Therapy)
4. Countdown to next change of Lateral Tilt (remaining HOURS:MINUTES:SECONDS)
5. Cycle counter
6. Indicator of Backrest Angle
7. Bed picture in current Lateral Tilt
8. Indicator of current direction to next phase of Automatic Lateral Therapy
9. Indicator of Longitudinal Tilt Angle (Trendelenburg Angle or Antitrendelenburg Angle)

#### To stop a running Automatic Lateral Therapy:

- Press STOP Icon (2).
- Adjust the bed to horizontal position by pressing the icon .
- Press Tick Icon.

