

LiteGait

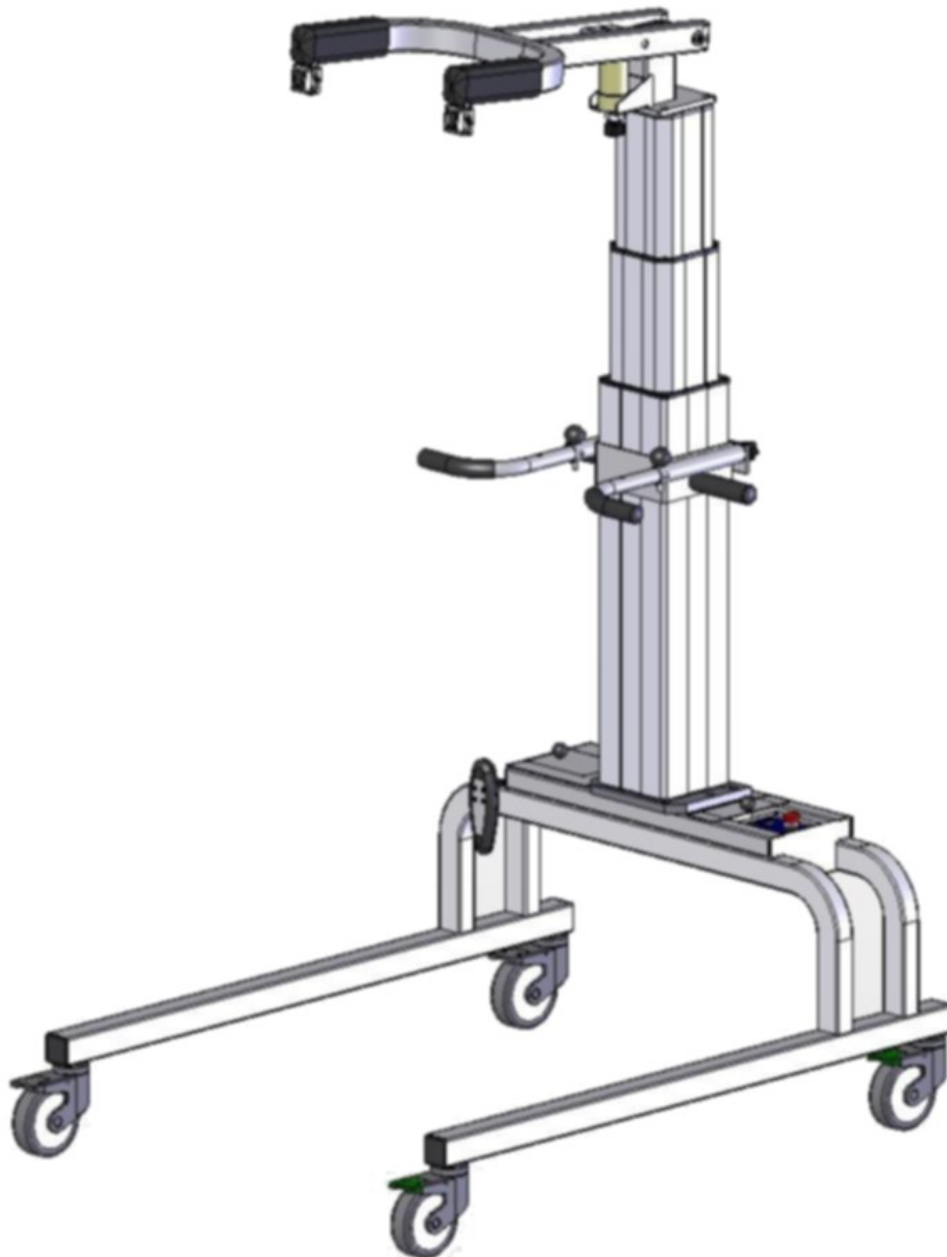

Operator & Service Manual
LiteGait I 360E

SERIAL NUMBER

Serial Number of Your Device: _____

Note: Please keep your serial number in a safe and secure location. The serial number must be provided when seeking service for your Lite**Gait** device. The serial number provides us access to technical information regarding your device.

WARNING

Maximum patient weight:

LGI-360E

360 lbs.

Maximum Unit Height:

7' 8"

Use only under the direct supervision of a health care professional or caregiver

Brakes should remain locked except when moving over ground

Operate only on a smooth, level floor

Dear LiteGait User,

CONGRATULATIONS on your recent purchase of LiteGait, the most innovative gait and balance therapy training system available today. As you know, LiteGait can be used with a wide variety of patient impairment levels and conditions. If you have questions about the possible uses of LiteGait with particular patients, or are in need of some ideas for ways to use LiteGait more effectively, please do not hesitate to contact us for information relating to your individual situation. Our website also offers valuable information.

Like all quality therapy equipment, LiteGait requires regular inspections. Enclosed is a check list for your convenience. Please complete the check list every 6 months to ensure the efficient, safe, and effective operation of the LiteGait unit. If you should find a problem with a LiteGait part, please contact the Technical Support Department immediately. Here are some phone numbers which will be of help to you:

TECHNICAL SUPPORT:	480-829-1727 Ext. 7104
SALES & CUSTOMER SERVICE:	800-332-9255
TechSupport E-Mail:	TechSupport@LiteGait.com
Website:	www.LiteGait.com
User Forum	www.LiteGait.org

Sincerely,
Customer Service Department
Mobility Research

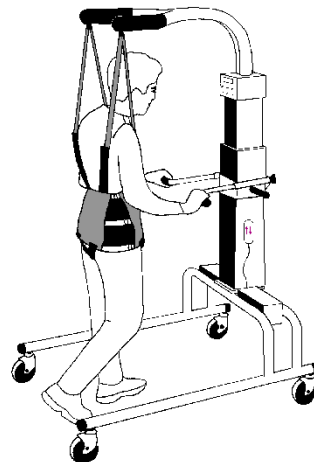

TABLE OF CONTENTS

UNPACKING AND ASSEMBLY	6
ABOUT YOUR UNIT	9
ASSEMBLY DIAGRAM	10
USING YOUR LITEGAIT	11
How to adjust the height of the yoke.....	11
Overhead Buckles and Straps.....	12
Harness Application	13
Harness and Groin Piece Preparation	13
How to put on the Harness.....	13
Harness Application in Supine (Laying on Back)	14
Harness Application While Standing.....	15
Groin Piece Attachment.....	15
How to Connect the Harness to your LiteGait.....	16
Control Unit	17
Adjusting the Handlebars	18
Base and Casters	19
Total-Lock Caster	19
Base and Casters	20
Directional-Lock Caster	20
BiSym Scale (Optional)	21
Components.....	21
BiSym Scale (Optional)	22
Zeroing	22
BiSym Scale (Optional)	23
Calibrating Gain	23
BiSym Scale (Optional)	24
Battery Overview.....	24
Over a Treadmill.....	25
Over Ground	26
MAINTENANCE CHECKLIST	32
Actuator	34
Batteries and Battery Charger	35
Casters (Moving your LiteGait)	36
Harness	37

UNPACKING AND ASSEMBLY

Tools Required:

Scissors
1/2 inch socket or open-end wrench
5/16 inch Allen wrench (provided)

















LiteGait I Assembly Instructions:

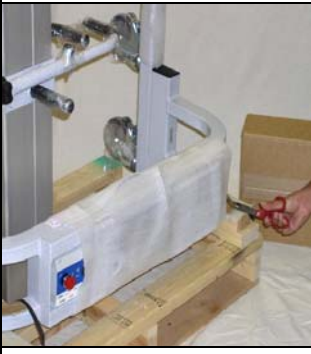















TWO PEOPLE ARE REQUIRED FOR SAFE ASSEMBLY

Read below & follow pictures on the following pages:

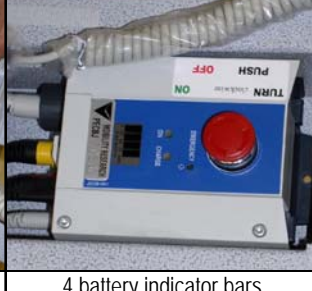
Note: The LiteGait in the photos may not look like yours, but the steps are the same.

1. Inspect shipment and note any visual damage to box and/or crate
2. Remove screw located at the bottom of crate
3. Lift off exterior box in order to expose equipment
4. Loosen handle bar knobs and raise handle bars
5. Remove cardboard box, (CAUTION: DO NOT USE UTILITY KNIFE TO OPEN BOX)
6. Inspect contents of card board box for damage
7. Carefully cut all black plastic straps.
8. Free and remove base with two people.
9. Set base over pallet as pictured with actuator next to base.
10. Cut packaging from base.
11. Locate and remove hand switch from inside base, set aside next to control box.
12. Remove covers for battery compartment and control box cover; set aside.
13. Locate 4 black steel bolts and Allen wrench in small box.
14. If black bolts are in base, remove with Allen wrench provided.
15. Locate bolts holding actuator to pallet. Undo bolts with ½ inch socket or wrench, loosen actuator from pallet with one person holding the actuator steady while loose.
16. Lower handlebar base on actuator and tighten knobs before lifting.
17. Ensure base is ready for positioning actuator.
18. Two people lift actuator from pallet to base.
19. Orient the actuator on the base (the yoke arms and handlebars point in the same direction as the base legs). Line up the holes for bolts to be inserted.
20. Insert bolts, hand tighten bolts (ensure one person holds actuator steady until secure).
21. The 5/16 inch Allen wrench may be used to tighten bolts (careful not to over tighten).
22. Line up actuator connector, and insert actuator connector.
23. Twist/release the red button; check 4-bar battery indicator on control box.
24. Verify connection and operation by moving actuator up/down by pressing the arrows on the hand switch.
25. If hand switch fails to operate the actuator, check connections to control box.
26. Carefully remove all shrink-wrap from the unit.
27. Verify performance of each locking and directional caster.
28. Feel free to call 1-480-489-1727 Extension 7104 for Mobility Research Support during this assembly.

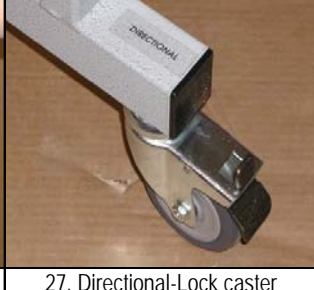
			
1. Inspect box for damage	2. Undo base boards screws	3. Remove box and set aside	Expose & examine content
			
4. Loosen knobs	5. Remove box	Open box (CAUTION: DO NOT USE UTILITY KNIFE)	6. Inventory box content
			
7. Cut straps	Cut straps	8. Free and remove base	9. Free and remove base
			
10. Cut packaging from base	11. Locate and remove hand switch	Move hand switch to side	12. Remove covers; set aside

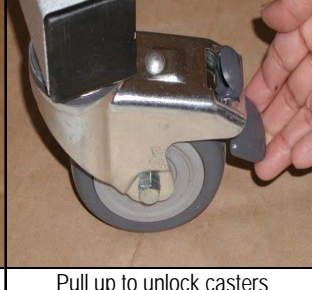
			
13. Ready base for actuator	15. Remove bolts; 1/2" wrench	16. Lower Handlebar base; secure	18. 2 people raise actuator
			
19. Set actuator on base	Line up holes; insert bolts	20. Hand tighten	21. 1/2" wrench; don't over tighten
			
22. Line up actuator connector	Insert actuator connector	23. Release Red EMO button	4 battery indicator bars
			
24. Test raise actuator up/down	26. Remove shrink wrap; Do Not use knife! Scissors if necessary, avoid cutting socks		
			
Unwrap casters	27. Directional-Lock caster	Locking caster	Pull up to unlock casters

ABOUT YOUR UNIT

LITE**GAIT** is comprised of several parts:

YOKE: The yoke is a Y-shaped piece that has four female buckles at the ends. It is attached to the actuator with a flat plate secured by four bolts.

OVERHEAD STRAPS: The overhead straps consist of four 44" long adjustable straps with male connectors at one end and padded female buckles at the opposite end. The male connectors attach to the yoke buckles and the female buckles attach to the harness. The overhead straps provide postural support for the patient.

HARNESS/GROIN PIECE: The harness is an adjustable wrap with a buckle closure in the front and three adjustable straps on each side. There are four male connectors at the top of the harness that attach into the female buckles of the overhead straps. The four female buckles at the bottom of the harness allow for the connection of the groin piece. The H-shaped stitching on the groin piece denotes the top (or body side) of the piece.

ACTUATOR: The actuator is the mechanism that raises and lowers the yoke. It consists of a concentric expanding and retracting square tower that houses the DC motors, gearing and the screw mechanism. It also provides the structural base to which the adjustable handlebars are attached.

CONTROL UNIT: The control unit is the junction box for the battery power, handheld switch and contains electrical safety protection circuitry. It is located within a compartment of the base. The battery pack connects to this unit and is also located within a compartment of the base. A large spring-assisted red button is located on the face of the control unit. A small emergency down pin hole is located on the blue face of the control unit.

HANDLEBARS: Your unit has two adjustable handlebars. The handle bars are attached to the unit using two knobs. (Note: Over tightening the knobs may cause damage)

BASE: The base consists of two horizontal bars connected by two U-shaped tubes. The base has an open end and a closed end where the actuator and battery pack are placed. The base moves freely overground or can be locked into place during use over a treadmill. However, your unit must be locked into place at all other times.

CASTERS: Four casters are attached to the base. Two locks on one side of the base are locking brakes and the two on the opposite side are directional locks. Be certain to lock both caster brakes when using the unit over a treadmill or when connecting the patient to the unit. **NEVER leave the patient unattended in the unit.**

BISYM (Optional): The BiSym Scale is installed on top of the actuator and provides a display of the pounds/kilograms of support provided by each arm of the yoke. The load cells that are installed in the yoke sense the load on the yoke and feed it to the BiSym Scale for processing and display.

ASSEMBLY DIAGRAM

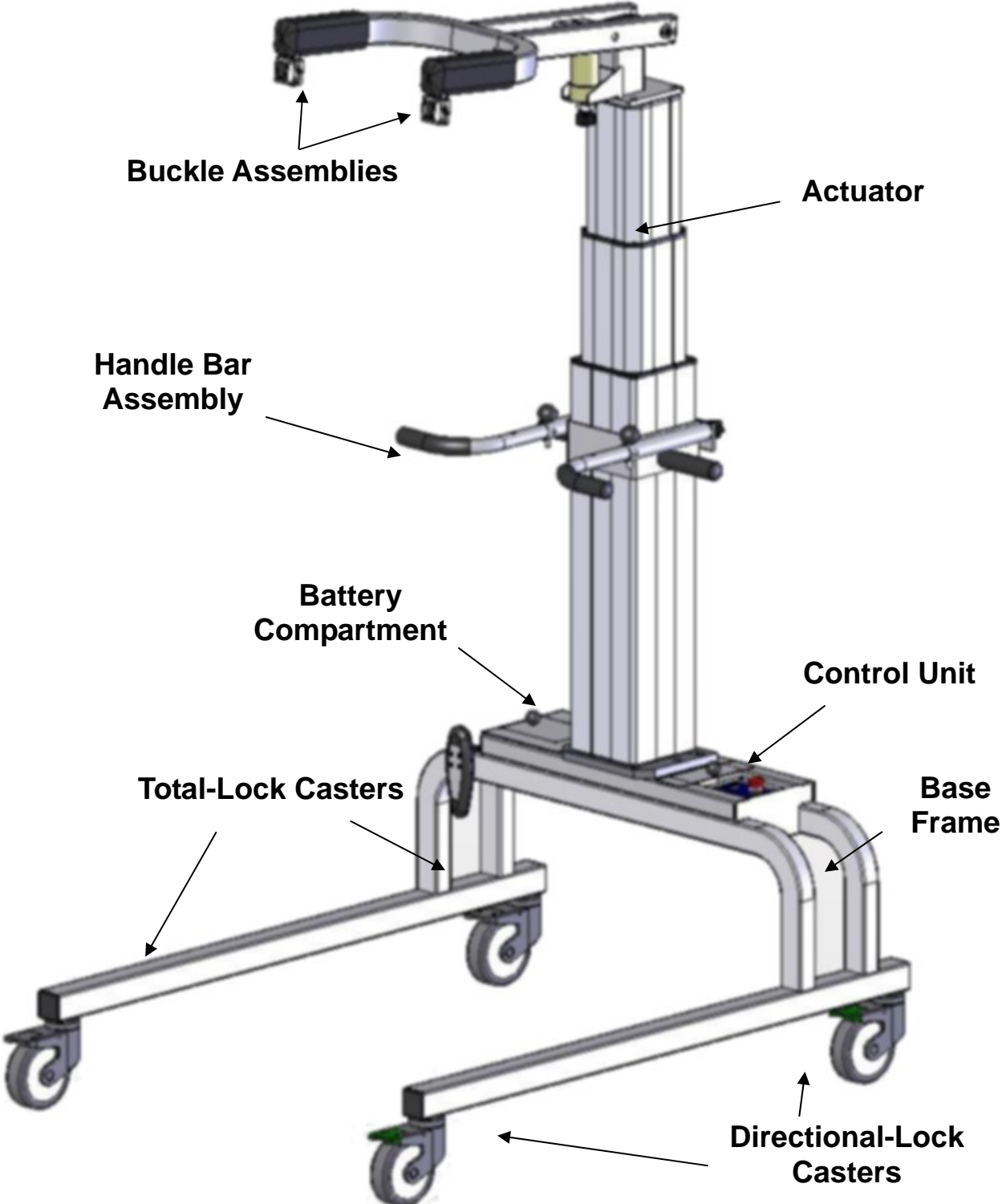

USING YOUR LiteGait

How to adjust the height of the yoke

The LiteGait powered yoke is raised and lowered by a hand-held switch with two up ↑ and two down ↓ arrows.

Raising the yoke: Verify that LiteGait has clearance above the yoke. Press the up ↑ arrow on the hand-held remote switch. Release the button when the yoke is at the desired height.

Lowering the yoke: Verify that LiteGait has clearance below the yoke. Press the down ↓ arrow on the hand-held remote switch. Release the button when the yoke lowers to the desired height. Maintain at least 5" clearance above the patient's head.



USING YOUR LiteGait

Overhead Buckles and Straps

Each of your unit's four straps can be individually adjusted. Adjust each strap to assure that the patient is in a fully upright position in the correct posture for walking.

1. To tighten straps:
With one hand pull up on the strap attached to the harness.
With the other hand, pull down on the free end of the strap.
2. To loosen straps:
With one hand, hold the overhead buckle outwards.
With the other hand pull down on the part of the strap attached to the harness.
3. To prevent the patient leaning to one side, e.g. right side:
Tighten the **front** and **back** straps on the right side.
4. To prevent the patient from leaning forward:
Tighten the right and left **FRONT** straps.
5. To prevent the patient from leaning backward:
Tighten the right and left **BACK** straps.
3. To prevent the patient leaning to one side, e.g. right side:
Tighten the **front** and **back** straps on the right side.
4. To prevent the patient from leaning forward:
Tighten the right and left **FRONT** straps.
5. To prevent the patient from leaning backwards:
Tighten the right and left **BACK** straps

USING YOUR LiteGait

Harness Application

Harness and Groin Piece Preparation

1. Pick the appropriate harness and groin piece for the patient (based on patient girth).
2. Estimate the harness girth before placing on the patient by folding the harness in half so that the ends meet. Then, hold the harness in front of the torso to estimate the width from one side of the body to the other.
3. Tighten or loosen the 3 rows of side straps on each side of the harness. (To loosen the side straps lightly pull up on the black tabs on the side buckles.)
4. Keep the harness folded in half and align the top buckles so that they are adjacent with each other.
5. Take the groin piece and adjust the groin strap padding towards the center of the strap **before** putting it on.
6. Adjust the front groin straps so they are equal in length.
7. Adjust the back groin straps so they are equal in length.
8. Attach the groin piece to the back of the harness.
9. The side of the groin piece with the H-outline stitching (most padded) will go against the patient's body.

How to put on the Harness

The harness was designed to support a patient in an upright position, allowing for full hip extension. This upright posture plays a critical role in the effectiveness of the gait therapy performed with partial weight bearing.

The front of the harness wrap refers to the point at which the two ends of the harness meet. The harness can be worn with the closure either in the front or in the back. There are four buckles on the top and bottom of the harness wrap. The four top buckles extend beyond the harness from the top seam and attach to the LiteGait straps. The bottom four buckles attach to the groin piece and do not extend past the bottom seam of the harness.

USING YOUR LiteGait

Harness Application in Supine (Laying on Back)

1. Patient should be lying down on his/her back.
2. Place one end of the harness on the mid-lower abdomen.
3. Roll the patient on his/her side away from you.
4. Place the harness on the center of his/her back so that the top buckles are equal distances from the spine.
5. Place the lowest harness side strap over the greater trochanter. The greater trochanter is a boney prominence on the side of the upper leg approximately on patient's hand length below the waist.
6. Pass the groin piece between the legs to the front.
7. Tighten the groin piece at the back leaving enough length for the front to attach.
8. Hold the harness with your hand.
9. Roll the patient back onto his/her back.
10. Wrap the harness to meet the other end in front.
11. Attach the front buckles.
12. Check the midline position of the harness by feeling for both upper buckles behind the patient's back. (They should be the same distance from the spine.)
13. Rotate the harness to adjust, if necessary.
14. Tighten the lower side straps first, as symmetrically as possible. **These straps are crucial to the proper distribution of the patient's weight and should be as tight as possible. To ensure a snug fit, pull the strap closest to the body towards its black plastic buckle with one hand while pulling the free end with your other hand until you cannot pull anymore.**
15. Tighten the middle and upper side straps. Make sure to tighten both sides symmetrically (equally) so that an equal strap length remains on each side. These should be as tight as the patient can tolerate without discomfort. The top strap should not interfere with breathing. Bulges of fatty tissue should be apparent (visible on most patients) as the harness is tightened. These bulges are very important and will allow the harness to securely grab onto the soft tissue of the abdomen, keeping the harness securely in place throughout the training.

USING YOUR LiteGait

Harness Application While Standing

1. Wrap the harness around the patient's torso.
2. Place the lowest strap over the greater trochanter.
3. Attach the front buckles.
4. Tighten the lowest straps first (see Tightening side straps section).
5. Attach the groin piece (see Groin piece attachment section).

Groin Piece Attachment

1. Attach the groin piece to the front harness buckles. The stitched side of the groin piece should be facing up against the body.
2. Hold the padded part of one end of the groin piece with one hand.
3. Pull it against the patient's leg. Keep holding it while the other hand pulls the free end of the groin strap.
4. Tighten the groin strap **snugly** so there is **NO** slack.
5. Repeat on the other side.
6. Pull out any wrinkles or bunching from the patient's clothing.
7. Sit the patient up or stand the patient, if safe

ENSURE AT ALL TIMES THAT THE BOTTOM STRAP OF THE HARNESS IS AT THE LEVEL OF THE GREATER TROCHANTER (HIP JOINT CREASE).

Contrary to what may seem reasonable, a loose groin piece DOES NOT impart greater comfort to the patient, but allows the harness to slide up the trunk, putting unwanted load/force on the groin area. Tighten the groin strap so that no slack remains in the straps. This assures that the harness will not ride up on the patient.

USING YOUR LiteGait

How to Connect the Harness to your LiteGait

1. Lock the caster brakes.
2. Adjust the yoke to the correct position, giving the patient approximately 5-6 inches of head clearance.
3. Extend the overhead straps until they are long enough to reach the upper connection on the harness. Attach the four buckles that hang from the overhead straps to the appropriate buckles on the harness. Pull on the straps until taut.
4. With the patient in the harness, bring the patient into a standing position directly under the yoke buckles. Have the patient hold the handlebars. Adjust the handlebar height to suit the patient.
5. Your unit can now be used for over ground therapy, or to assist the patient in stepping onto the treadmill.
6. With higher level patients, the unit may be positioned over the treadmill before the patient is buckled into place.

NOTE: Under no circumstances should a patient have ALL the weight removed from the legs for more than two minutes at a time.

USING YOUR LiteGait

Control Unit

LiteGait is equipped with a 24 volt battery pack. It is highly recommended to establish a daily or biweekly schedule for charging the battery.

To recharge your battery:

Remove cover to Battery Compartment

Pull out the charging adapter cord and plug the cord into the appropriate 110 or 220 volt outlet.

The charger automatically tapers off the charging current when the batteries are nearly charged.

Coil adapter cord into Battery Compartment and replace cover.



THE BATTERIES MUST BE CHARGED AT LEAST TWICE A WEEK TO MAINTAIN PROPER FUNCTION AND TO AVOID DAMAGE TO THE BATTERY.

USING YOUR LiteGait

Adjusting the Handlebars

Raising and lowering the handle bars: Loosen each knob in equal portions. The knobs should only need to be turned once to free the handle bars. Once the knobs are loosened slide the handle bars to the desired height. Hand tighten both knobs equally. Again, the knobs should only need to be tightened one rotation.

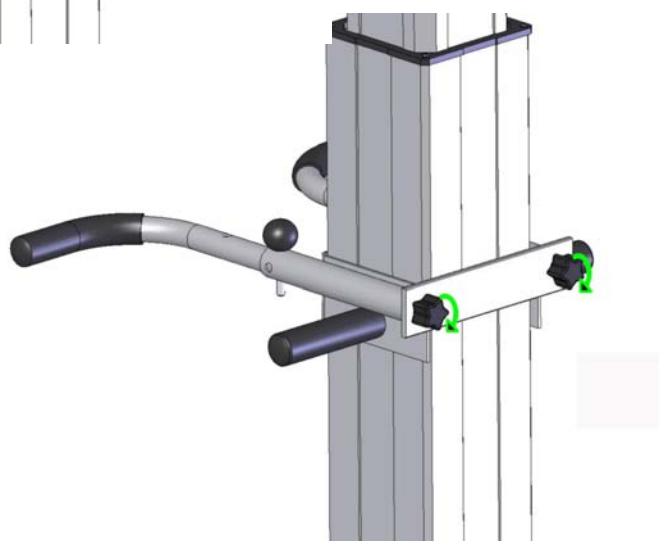
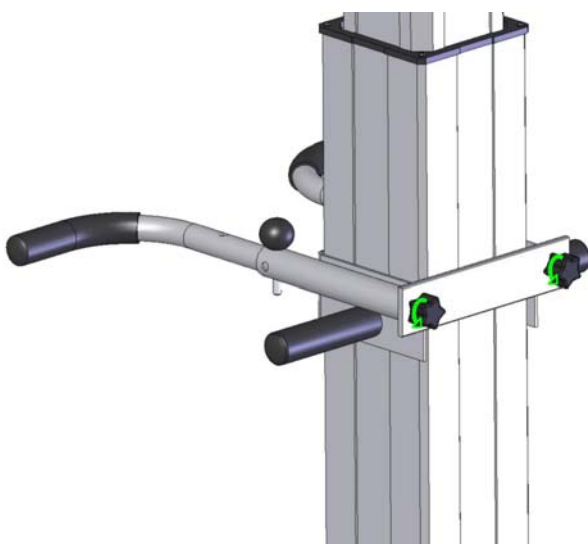

USING YOUR LiteGait

Base and Casters

Total-Lock Caster

LiteGait is equipped with four casters. There are two total-lock casters and two-directional lock casters. Each leg has one type of caster. Directional lock casters have a green brake lever. Standard casters have a gray brake lever.

To lock the total-lock casters press the caster brake until you feel the brake snap into place.

The caster brakes should be locked whenever the LiteGait is not being moved over the ground.

CAUTION: While locking the casters prevents rolling of the unit, it does not prevent the unit from sliding on a sloped, slippery floor. The unit should only be used on a flat floor and away from stairs and ramps. NEVER leave a patient unattended in the unit.

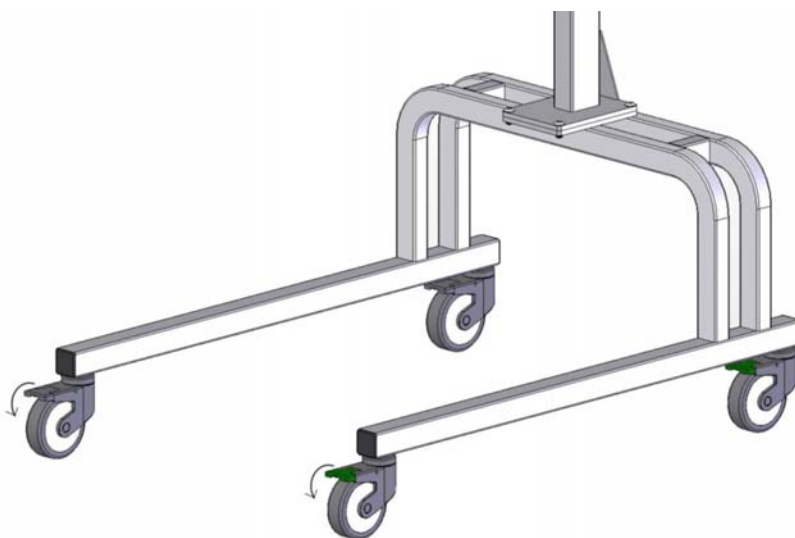

USING YOUR LiteGait

Base and Casters

Directional-Lock Caster

Directional lock casters facilitate rolling the device back and forth over a treadmill or down a hallway. The directional lock casters will have a green brake. Once the unit is positioned over a treadmill, all four caster brakes need to be locked.

1. Position Lite**Gait** near the treadmill (or where you wish the patient to begin walking).
2. Roll Lite**Gait** towards the front of the treadmill, until the casters line up parallel to the treadmill (or parallel to the path the patient will follow—a hallway for example).
3. Press the directional locks. This will prevent the caster from swiveling.
4. Lite**Gait** can now be easily rolled back and forth over the treadmill or on a straight path in the therapy room or hallway.

NOTE: When walking patients over ground, first establish the direction of movement, then lock the directional casters to ensure the best performance. To move in the opposite direction, release the caster brakes and re-establish the direction of movement. That is, allow the casters to follow the movement rather than lead it.

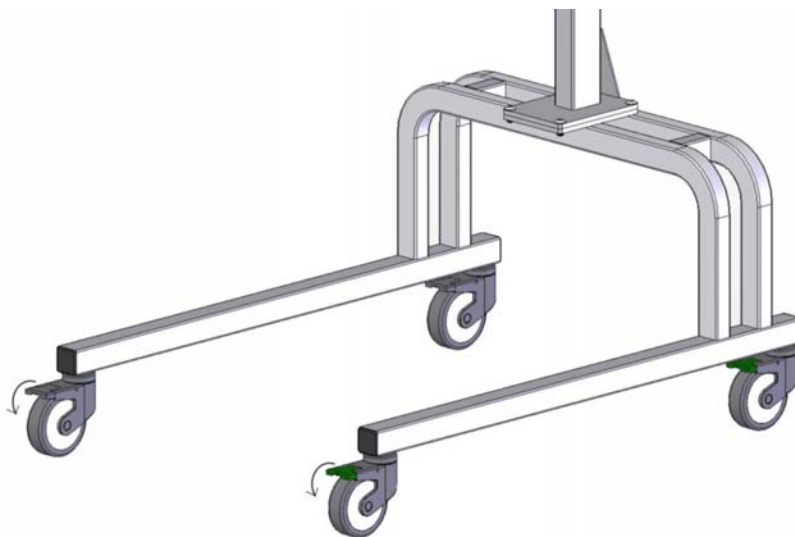

USING YOUR LiteGait

BiSym Scale (Optional)

Components



ON/OFF/(ON) Switch:

The BiSym Scale uses a three way toggle switch for turning on power. It is recommended the BiSym remain in the center “OFF” position when not in use. Switching the toggle up to the “ON” position will operate the BiSym Scale continuously until switched back to the center “OFF” position.

Liquid Crystal Display (LCD) Digital Panel Meter:

The LCD Digital Panel Meter display allows for monitoring of the load transferred from the harness to the yoke. It can display the support load from the right, left or the sum of both sides as the patient is being monitored. All BiSym Scales are set and calibrated at the factory to read in pounds (+/- 1 lb) or, if requested, kilograms (+/- 0.1 Kg).

L/SUM/R Switch:

Flipping the 3-way toggle switch below the LCD to the L position allows monitoring the support load on the left side of the patient. Flipping the toggle switch to the R position allows for monitoring the support load on the right side. Flipping the toggle switch to the SUM position allows for monitoring the total support load on the LiteGait unit.

Load Cells (R & L):

Two sensors terminating in phone type connectors and are connected to the rear of the BiSym Scale.

Zero (R & L):

The two multi-turn potentiometers set the zero readings for each side. It is factory set to read zero with the harness and straps attached.

Note: Before making any changes to these potentiometers be sure to check the AA batteries are fresh and installed properly.

USING YOUR LiteGait

BiSym Scale (Optional)

Zeroing

To adjust the scale with harness and straps attached simply follow these steps using the largest harness:

1. Attach the harness and straps. No patient is needed for this procedure.
2. Harness straps must be positioned at equal lengths to insure equal distribution of the weight of the harness to both sides.
3. Switch the toggle switch on the BiSym to the L (left) position. The monitor should display the load on the left side.
4. Turn the shaft of the potentiometer on the left side slightly until it reads zero.

Note: A small flat head screwdriver is needed.

Tip: An eyeglass screw driver can be used to turn the potentiometers.

The direction of the turn may vary from side to side. Turn the direction that brings the numbers closer to zero.

Note: Over turning the potentiometers may cause damage.

5. Redo steps 3 and 4 for the R (right) position.
6. Confirm the SUM position on the toggle switch displays a BiSym reading of zero.

USING YOUR LiteGait

BiSym Scale (Optional)

Calibrating Gain

These potentiometers allow for re-calibration of the reading displayed. It is factory set to read 50 for a 50-pound load (+/- 1 lb) or, if requested, 50-kilograms load (+/- 0.1 Kg). The calibration can be periodically checked (every 6 months to a year) by following these steps:

Note: Gain may not be available for adjustment by user.

1. Attach a known weight to the yoke's left arm of the LiteGait device.
2. Toggle the switch to the L (left) position.
3. Adjust the gain if the weight on the yoke's left arm does not match the reading displayed on the BiSym Scale. To adjust the gain, turn the shaft of the associated potentiometer on the left side slightly clockwise or anticlockwise until it reads the correct weight.

Note: A small flat head screwdriver is needed.

Tip: An eyeglass screw driver can be used to turn the potentiometers.

Note: Over turning the potentiometers may cause damage.

4. Repeat steps 1 through 3 for the yoke's right arm of the LiteGait device by utilizing the R (right) toggle position.
5. The last step to verify the gains of your BiSym Scale is to suspend known weight from both arms of the yoke of the LiteGait device. Position the toggle switch to the SUM position and verify that the BiSym scale displays the correct weight.

USING YOUR LiteGait

BiSym Scale (Optional)

Battery Overview

Battery Functions:

Your BiSym is powered by two sets of batteries with two separate functions. The four AA batteries power the Load Cells and processing on the electronics. The 9-volt battery powers the LCD monitor.

Battery Life:

The 9-volt battery will last significantly longer than the four AA batteries. Weak/Dead AA batteries will result in erroneous values in the display. Weak/Dead 9-volt battery will result in a blank LCD when toggled in the "ON" position. When the toggle switch is in the "ON" or momentary "(ON)" position, current is drawn from both sets of batteries. *Flip the toggles switch to the "OFF" position when not in use.* Battery life will depend upon usage.

Battery Orientation:

It is very important to follow the diagrams inside the two battery holders when replacing batteries. Although there is only one way to load the battery holder into the receiving BiSym box, there is a possibility of orienting the batteries incorrectly into the associated carriers. *If the 9-volt battery is loaded incorrectly into the holder and installed into the receiving BiSym box, the LCD will suffer damage and it will require replacement.*

Battery Replacement:

The BiSym is equipped with fresh alkaline batteries. These may be replaced with standard or rechargeable batteries. Mobility Research offers affordable rechargeable battery kits that are optimal for use with the BiSym Scale. Contact Technical Support for more information.

Confirm battery orientation when loading into holders.

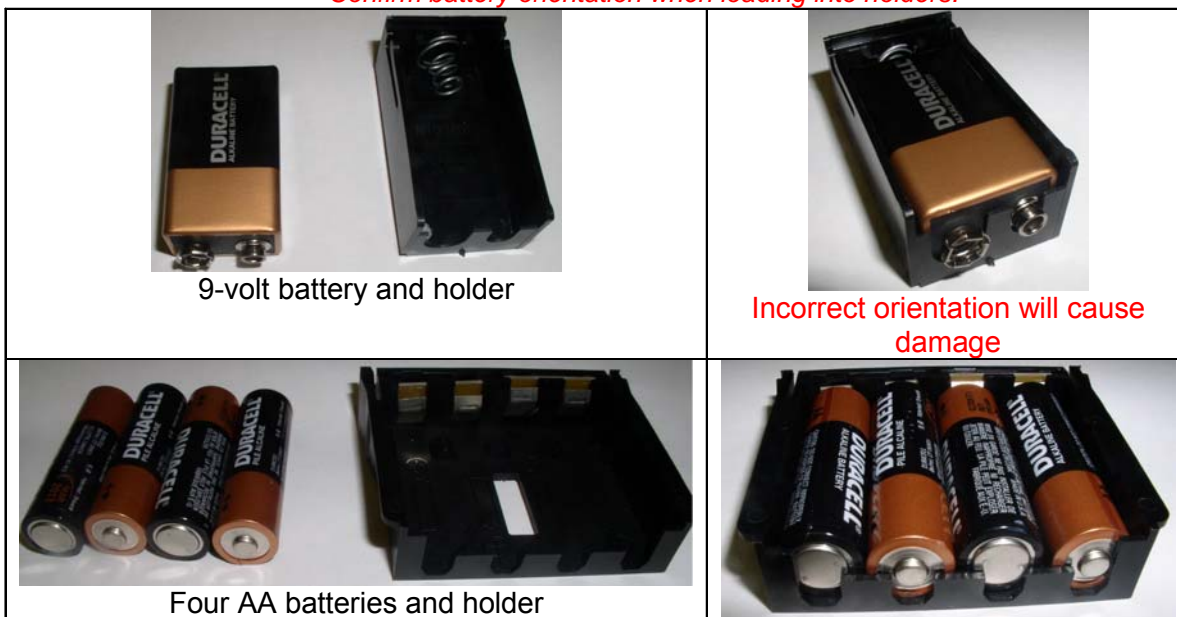

If you should have any question, please contact:
Technical Support at 480-829-1727 ext. 7104

TRAINING WITH LiteGait

Over a Treadmill

1. Measure the height of the treadmill walking surface to the ground and add 5 inches to that number (example: treadmill walking surface height is 8" + 5" = 13").
2. The yoke height should be adjusted so that the top is approximately 5 inches above the patient's head when standing on the treadmill.
3. Lock the directional locks and position the unit over the treadmill.
4. Position the patient at the rear of the treadmill walking surface, facing the treadmill. The patient should either be seated in a wheelchair, on a chair, or standing with the help of an assistive device on the ground at the rear of the treadmill.
5. Roll the unit to the rear of the treadmill and lock the caster brakes.
6. The patient may hold onto the adjustable handlebar. Stand the patient up. For lower level patients, skip this step until the patient is connected to the LiteGait unit.
7. Attach the four buckles on the overhead straps hanging from the yoke to the harness. (Be careful to attach the front straps to the front buckles and the back straps to the back buckles.)
8. Tighten each strap by gently lifting up on the connected section of the strap and pulling down on the loose end of the strap simultaneously. Repeat the procedure with all four straps, making sure that the straps are of equal length when finished.
9. Double check that all four straps have been connected to the appropriate buckles on the harness and all the straps have been tightened equally.
10. At this point, the patient should be securely buckled and attached to the unit.
11. For the seated patient, raise the yoke until the patient is in a standing position. Retighten each strap as necessary.
12. Standing beside the patient, slowly roll the unit forward toward the front of the treadmill. This position will allow you to both roll the unit and assist the patient with stepping forward onto the treadmill walking surface.
13. When the patient steps up on the treadmill, quickly re-tighten all four straps as necessary to increase the support provided by the unit.
14. Continue to roll the unit over the treadmill as far forward as possible, while the patient walks.
15. Once the unit is at the front of the treadmill, **lock the caster brakes**.
16. Double check to see that the unit is locked into place and that the patient is in the center of the treadmill walking surface.
17. Adjust the handlebar to the appropriate height.
18. To exit the unit, reverse the process.

TRAINING WITH LiteGait

Over Ground

1. Adjust the yoke height so that it is approximately 5 inches above the patient's head when standing. Or, lower the yoke so that it is approximately 5 inches above the patient's head when sitting.
2. The patient should either be seated in a wheelchair, on a chair, or standing on the ground with the aid of an assistive device.
3. Position the unit over the patient.
4. Lock the caster brakes.
5. Loosen the straps and connect the appropriate straps to the harness being sure to connect the front straps with the front buckles and the back straps with the back straps.
6. Stand the patient up. (The patient may hold onto the adjustable handlebar.)
7. Tighten all four straps until the patient is standing in the proper upright posture.
8. Make any postural adjustments by tightening or loosening the appropriate strap.
9. Adjust the handlebar to the appropriate height.
10. As the patient begins to move over ground, several options are possible depending on treatment goals and the patient's ability:
 - a. Push the unit matching the patient's rate of walking.
 - b. Push the unit faster to increase the patient's rate of walking.
 - c. Allow the patient to push the unit with or without assistance.
 - d. Allow the patient to walk forward, backward, or laterally.

NOTE: The caster brakes should be locked whenever the unit is stationary. Release the caster brakes only for movement of the unit.

UNIT CARE

Your Lite**Gait** has been specially designed to be durable and relatively maintenance free. The Lite**Gait** unit consists of a steel frame, functioning parts (such as casters and knobs), and soft parts (such as the hand grips, harness, straps, etc.). The frame is constructed from high strength steel, and has been painted with a special powder coat to resist rust and scratches.

To clean the frame, follow the instructions outlined in the table below. The harness has been made of an exceptionally durable fabric to retain its shape and effectiveness through many uses and washings. However, it is imperative that the harness be stored properly to prevent damage to the buckles. When not in use, store the harness in a place or area that will prevent the harness from being stepped on or rolled over. The crushing downward force of a wheel chair or cart rolling over the harness would damage the buckles, making the harness ineffective and unsafe for further use. When washing the harness and groin pieces, please follow the instructions outlined in the table below.

	Frame	Harness	Groin Pieces
Frequency	* FOLLOW STANDARD FACILITY INFECTION CONTROL PROCEDURES.		
Cleaning Agent	DILUTED WINDEX TYPE CLEANING SOLUTION	STANDARD LAUNDRY DETERGENT	STANDARD LAUNDRY DETERGENT
Water Temperature	N/A	WASH IN HOT RINSE IN COLD	WASH IN HOT RINSE IN COLD
Drying Method	WIPE DRY WITH CLEAN CLOTH	LINE DRY	LINE DRY
Special Cleaning Instructions	WD-40 CAN BE USED TO REMOVE DIRT OR OILY SPOTS.	WASH SEPARATELY (GROIN PIECE CAN REMAIN ATTACHED TO HARNESS)	WASH SEPARATELY (GROIN PIECE CAN REMAIN ATTACHED TO HARNESS)

PARTS LIST

LiteGait I-360E Parts List			
PART	DESCRIPTION	PART #	PIECES INCLUDED
BASE	LOW 30" inner frame	B36G30L	1
	STND 30" inner frame	B36G30	
	STND 34" inner frame	B36G34	
	LOW 34" inner frame	B36G34L	
	PLFM 34" inner frame	B36G34	
Base Caps	The 2 x 2 inch, black covers for the legs of the base.	B36G30L	4
Locking Caster	Wheel with hardware that locks via a black colored flap.	B36G30L-C	2
Directional Caster	Wheel with hardware that locks into one direction via an aluminum colored flap.	B36G30L-D	2
ACTUATOR/POST	Battery operated lift mechanism capable of lifting up to 360 pounds with a lift of 32" depending on the rating of your unit.	P50MS (32" lift)	1
Bolts for Base	3/8 in Standard	P50MS-C	4
Bolts for Yoke	11 mm Standard	P50MS-D	4
SCALE	Bisym: 3 readouts	PBS	OPTIONAL
	A digital read out scale that displays the amount of load reduction on the lower extremities. Uni-Scale: 1 readout	PSC	
RECHARGABLE BATTERY PACK	Optimal for the use with a scale. Comes with 8 AA rechargeable batteries and a charger.	PBS-B	OPTIONAL
HANDLEBARS	Complete handlebars include handlebar arms and metal frame.	HB50E	1
Handlebars Base Box	Part of the handlebars that encompasses the circumference of the actuator/post.	HB50E-A	1
Handlebar Plate	Flat plate that sits between the posterior knobs to fasten and the handlebars base box.	HB50E-B	1

PARTS LIST

LiteGait I-360E Parts List			
Knobs	Posterior knobs used to fasten plate to handlebars base box. These are round and allow the handlebars to be securely locked into the correct position on the actuator/post.	HB50E-C	2
Handle Covers	Black 5" covers for the handles of the handlebars base box.	HB50E-D	2
Adjustable Handles	Handle is connected to the handlebars base box and can be positioned proximal or distal and locked into place with handle pin. Does not include patient grip covers.	HB50E-G	2
Patient Grip Covers	Black 6" covers for the adjustable handles.	HB50E-E	2
Handle Pin	Pin used to reposition the adjustable handles.	HB50E-F	2
YOKE	The complete top Y-shaped portion of the unit with buckles attached.		
	Standard	Y40E	1
	Bisym/Uni-Scale Ready	Y40EZ	
Buckle Assembly	The female buckles are pre-installed in the yoke and allow the quick attachment of the straps. They mimic parallel bars.	Y40E-A	2
Socks	The soft, cushioned cloth coverings over the end of the yoke arms.	Y40E-B	2
Cartridge	Sits between the Yoke and the post attachment and is cylinder shaped.		
	Blank	Contact Us.	1
	FlexAble	Contact Us.	
Straps (no covers)	For Diaper with Metal Harness	HDJ-B	4
Seatbelt like straps with one male and one female connection. The male end connects into the buckles on the yoke. The female end connects into the buckles on the harness.	For Junior Harness	HJ-B	
	For Small Adult Harness	HS-B	
	For Adult Harness	HA-B	
Strap Covers	For Junior Harness	HJ-C	4

PARTS LIST

LiteGait I-360E Parts List			
The soft, cushioned material covering the female buckles of the straps that attach to the harness.	For Small Adult Harness		HS-C
	For Adult Harness		HA-C
HARNESS WRAP	Diaper with Metal: Max 30" Girth		HDJ-A
A rigid, washable cloth wrap used with attachments that provide postural support to the patient.	Junior: Max 33" Girth		HJ-A
	Small Adult: Max 45" Girth		HS-A
	Adult: Max 60" Girth		HA-A
Groin Pieces	For Junior Harness	6" Groin Standard	HJ-D
		8" Groin Standard	HJ-E
		9" Groin Optional	HJ-F
Padded, adjustable piece which connects to the harness and is positioned between the legs.	For Small Adult Harness	9" Groin Standard	HS-F
		10.5" Groin Standard	HS-G
		13" Groin Optional	HS-H
	For Adult Harness	9" Groin Optional	HS-F
		10.5" Groin Standard	HS-G
		13" Groin Standard	HA-H
Leg Straps	For Junior Harness		HJCS
Adjustable piece which connects to the harness and is positioned around the legs.	For Small Adult/ Adult Harness		HSCS
Harness Extender	7.5" extension to plug into front of the harness wrap.		
	For Adult Harness Wrap		PHAEX
POWER SYSTEM	The electrical system that controls the positioning of the actuator.		PS50E

1 for STND LG-1-360E/360ES

2 for STND LG-1-400E/400ES

2

OPTIONAL

OPTIONAL

1

PARTS LIST

LiteGait I-360E Parts List			
Actuator Cord	A split red and yellow color coded connection cord that electrically connects the control box to the actuator.	PS50E-A	1
Batteries	24V battery pack.	PS50E-B	1
Control Box	The electric junction box.	PS50E-C	1
Charger Cord	The AC adapter cord that plugs into a wall outlet and the control box.	PS50E-D	1
Hand Switch	The switch connects to the control box. The buttons allow for the adjustment of the height of the device.	PS50E-E	1
Battery Cover	Rectangular metal plate that covers batteries.	PS50E-G	1
Control cover	Rectangular metal plate, with a wedge removed, which covers the Control Box.	PS50E-H	1

MAINTENANCE CHECKLIST

To maintain the highest quality of function and safety, it is extremely important that you conduct regular maintenance checks of your LiteGait unit and all of its parts. Please refer to the following checklist for an inspection guideline. If you should have any questions concerning the functional status of any of the LiteGait parts, please contact the Technical Support department immediately at **800-332-9255**. It is recommended that you inspect the LiteGait unit and all of its parts every 6 months.

<p>Bolts: Check all bolts for tightness. Retighten all visible bolts taking care not to over tighten. Examine all bolts for visible wear and rust.</p>
<p>Knobs: Examine the knobs for cracking around the bolt collar. Screw the knobs in and out to determine if they are functioning smoothly. Carefully test to be certain that the knobs are tightening snugly and securely with no slippage.</p>
<p>Casters: Examine both the front and rear casters for visible wear and tear. Evaluate the function of the casters. Do the casters roll smoothly? Do the casters turn properly? Do the casters lock the unit into place?</p>
<p>Grips: Examine the hand grips for visible wear.</p>
<p>Buckles: Gently pull back the covering on the end of the Yoke arms to expose the buckles. Inspect the point at which the buckles are attached to the WalkAble Yoke to be certain of a solid and secure attachment. Replace the Yoke end coverings.</p>
<p>Straps: Examine the straps for fraying or worn fabric. Pay particular attention to the stitching at the site where each strap is attached to each buckle. Inspect each strap for a strong and secure attachment to each buckle.</p>
<p>Harness: Inspect the seams of the harness for fraying, tears, or worn fabric. Inspect the stitching around the metal connectors for a strong and secure seam. Examine the harness wrap for a firm and slightly rigid body. Carefully inspect the groin piece connectors for cracks, weakening or widening of the plastic connectors.</p>
<p>Groin Piece: Examine the overall appearance of the groin pieces. Inspect the straps of the groin piece for twisting. The straps should remain flat and straight for maximum performance. Inspect the seams for small tears or pulling of the fabric. Examine the plastic connectors for cracks or visible wear.</p>
<p>Caps/Plugs: Examine all of the caps for cracking and to determine if they are still intact.</p>
<p>Actuator: Unplug all AC connections. Disconnect all battery attachments from unit. Inspect all electrical connections (actuator plug, battery wires, cords) for melted or damaged wire covers, bare wires and/or unusual smells (burnt). Reconnect all attachments and test the function of the actuator. Does the actuator move up and down smoothly and consistently? Does the actuator move quietly, without squeaks? Does the actuator move upon command from the switch? Inspect the hand held switch and the cord for visible wear.</p>
<p>BiSym: If a BiSym is present, examine the cord for any visible wear. Is the BiSym calibrated properly? Hang a known weight from the left and then the right arm of the Yoke. Is the BiSym reading the weight accurately?</p>

MAINTENANCE CHECKLIST

Please rate the function of each item as follows:

1 = POOR 2 = FAIR 3 = GOOD 4 = EXCELLENT.

A rating of FAIR (2) or POOR (1) indicates that that part should be immediately replaced to maintain the safe and effective use of the equipment.

LITE GAIT MAINTENANCE CHECK LIST					
DATE:	EXCELLENT 4	GOOD 3	FAIR 2	POOR 1	NEEDS REPLACED OR UPGRADED
BOLTS					
KNOBS					
CASTERS					
GRIPS					
BUCKLES					
STRAPS					
HARNESS					
GROIN PIECE					
CAPS AND PLUGS					
ACTUATOR					
BISYM					

***PLEASE COPY THIS FORM AND COMPLETE EVERY 6 MONTHS.**

FACILITY/OWNER: _____

ACTION TAKEN: _____

BY: _____

DATE: _____

FAX COMPLETED FORMS

TO:

MOBILITY
480-829-0737

OR MAIL TO:

MOBILITY RESEARCH
P.O. BOX 3141
TEMPE, AZ 85280

TROUBLESHOOTING

Actuator

ACTUATOR		
	PROBLEM	SOLUTION
1.	The actuator does not function properly (does not go up or down).	The batteries may need to be recharged. Follow the standard battery charging procedure. (Also see the troubleshooting guide on batteries, on the next page, and the Recharging The Batteries section). If batteries are fully charged, see #2.
2.	If the actuator does not function properly and the batteries are fully charged. OR If your actuator is not able to extend/contract to its maximum or minimum height.	Verify that your Actuator Cord is plugged into the Actuator. The other end of the Actuator Cord splits into two black wires which are color coded at their ends. Verify that the yellow color coded wire is plugged into the yellow coded Ch 1 socket in the control box. Verify that the red color coded wire is plugged into the red color coded Ch 2 socket in the control box. Verify all ends of the cords are pushed in securely.
3.	While going up, there is a chirping sound coming from the base.	Your unit is equipped with a monitoring device designed to alert you when the battery charge is low. When you hear the chirping sound, charge the batteries.

IF YOU ARE HAVING PROBLEMS WITH YOUR UNIT, ATTEMPT TO IDENTIFY THE PROBLEM USING THE TROUBLE SHOOTING GUIDE. ONCE THE PROBLEM IS IDENTIFIED, CONTACT TECHNICAL SUPPORT FOR ASSISTANCE AT 800-332-9255.

TROUBLESHOOTING

Batteries and Battery Charger

BATTERIES AND BATTERY CHARGER		
	PROBLEM	SOLUTION
1.	The LiteGait device is not functioning properly (does not go up or down.)	The batteries may need to be recharged. Remove the cover on the battery compartment in the base. Pull out the charging adapter cord and plug it into the appropriate 100 or 220 volt outlet for approximately 8 to 10 hours.
2.	The control box 4-bar battery indicator is partially full, but when the actuator goes up or down it drops down 2 bars.	The batteries are at a critically low level and should be recharged. Remove the cover on the battery compartment in the base. Pull out the charging adapter cord and plug it into the appropriate 100 or 220 volt outlet for approximately 8 to 10 hours.
3.	The control box battery indicator is full or at 75%, but when the actuator goes up or down, you lose all bars.	The batteries are no longer accepting current and need to be replaced.

IF YOU ARE HAVING PROBLEMS WITH YOUR UNIT, ATTEMPT TO IDENTIFY THE PROBLEM USING THE TROUBLE SHOOTING GUIDE. ONCE THE PROBLEM IS IDENTIFIED, CONTACT TECHNICAL SUPPORT FOR ASSISTANCE AT 800-332-9255.

TROUBLESHOOTING

Casters (Moving your LiteGait)

CASTERS (MOVING THE UNIT)		
	PROBLEM	SOLUTION
1.	The device does not roll easily.	Check to be sure that all of the caster brakes are unlocked. To activate the directional locking mechanism on the unit, initiate the caster by flipping the lever and gently pushing the unit forward. The caster wheels MUST be in line with the legs of the base with the flap oriented behind the direction of movement for optimal performance. Test the forward and backward movement of the unit. If the problem still persists, go to #2.
2.	The caster(s) appears loose or broken.	Carefully and securely lay LiteGait on its back (with the yoke and the base arms pointing upward). Check to see if the caster appears to be firmly affixed to the LiteGait frame. If the caster appears to be loose, proceed to #3. If the caster appears to be broken, consult the Technical Support Department for further assistance.
3.	With the unit securely lying on its back, the caster(s) appear loose.	Attempt to tighten the bolt that secures the caster to the frame. If the caster cannot be tightened, consult Technical Support for assistance.
4.	The caster wheels appear to be worn or damaged.	Contact Technical Support for replacement wheels.

IF YOU ARE HAVING PROBLEMS WITH YOUR UNIT, ATTEMPT TO IDENTIFY THE PROBLEM USING THE TROUBLE SHOOTING GUIDE. ONCE THE PROBLEM IS IDENTIFIED, CONTACT TECHNICAL SUPPORT FOR ASSISTANCE AT 800-332-9255.

TROUBLESHOOTING

Harness

HARNESSES		
	PROBLEM	SOLUTION
1.	The patient is complaining of groin or harness discomfort.	Be sure that the harness and groin piece are securely tightened from the start.* The harness should be tight enough to grab on to the fatty tissue around the abdomen. The groin piece should then be tightened securely to keep the harness from riding up on the patient and creating unwanted pressure in the groin area. A towel can be wrapped around the patient's abdomen for added padding if needed.
2.	The harness is riding up on the patient causing pressure in the groin area.	The harness and the groin piece should be made as tight as comfortable for the patient, prior to the overhead strap attachment. Applying the harness and groin piece too loosely will cause them to slide upward.*
3.	The overhead straps are too far apart in the front causing discomfort in the chest area of the female patients.	Turn the harness around so that the closure is in the back.
4.	The overhead straps slip off of the shoulders of the patients.	Turn the harness around so that the closure is in the back.
5.	The patient cannot stand long enough to properly position and tighten the harness and groin piece.	Apply the harness with the patient in a supine position.

* Pay special attention to side strap tightening directions.

IF YOU ARE HAVING PROBLEMS WITH YOUR UNIT, ATTEMPT TO IDENTIFY THE PROBLEM USING THE TROUBLE SHOOTING GUIDE. ONCE THE PROBLEM IS IDENTIFIED, CONTACT TECHNICAL SUPPORT FOR ASSISTANCE AT 800-332-9255.

RESOURCE DIRECTORY

TECHNICAL SUPPORT	480-829-1727 Ext 7104 TechnicalSuport@LiteGait.org
EDUCATION	800-332-9255 Ext 7102 Education@LiteGait.com
SALES	800-332-9255 Ext 7101 Sales@LiteGait.com
FAX	480-829-0737
E-MAIL	Sales@LiteGait.com
WEB SITES	www.LiteGait.com www.LiteGait.org
MAILING ADDRESS	P.O. Box 3141 Tempe, AZ 85280

LiteGait I®

Limited Warranty Certificate

The Mobility Research warranty covers applicable parts and labor for repair or replacement as listed below:

- 3 years on frame components due to broken or damaged welds.
- 1 years on the lift mechanism or actuator
- 1 year on harness stitching, buckles and casters.
- 1 Year on optional BiSym electronics.
- 90 day warranty on battery due to defect.

Losses due to work stoppage, lost revenues, damages due to neglect or abuse **ARE NOT** covered by this warranty. Shipping and handling charges **ARE NOT** covered by this warranty.

THIS WARRANTY AND REMEDIES SET FORTH ABOVE ARE EXCLUSIVE AND IN LIEU OF ALL OTHER WARRANTIES, REMEDIES AND CONDITIONS, WHETHER ORAL OR WRITTEN, EXPRESS OR IMPLIED. MOBILITY RESEARCH LLC. SPECIFICALLY DISCLAIMS ANY AND ALL IMPLIED WARRANTIES, INCLUDING, WITHOUT LIMITATION, WARRANTIES OF MERCHANTABILITY AND FITNESS FOR A PARTICULAR PURPOSE. IF MOBILITY RESEARCH LLC. CANNOT LAWFULLY DISCLAIM IMPLIED WARRANTIES UNDER THIS LIMITED WARRANTY, ALL SUCH WARRANTIES, INCLUDING WARRANTIES OF MERCHANTABILITY AND FITNESS FOR A PARTICULAR PURPOSE ARE LIMITED IN DURATION TO THE DURATION OF THIS WARRANTY. NO MOBILITY RESEARCH LLC. RESELLER, AGENT, OR EMPLOYEE IS AUTHORIZED TO MAKE ANY MODIFICATION, EXTENSION OR ADDITION TO THIS WARRANTY. MOBILITY RESEARCH LLC. IS NOT RESPONSIBLE FOR DIRECT, SPECIAL, INCIDENTAL OR CONSEQUENTIAL DAMAGES RESULTING FROM ANY BREACH OF WARRANTY OR CONDITION OR UNDER ANY OTHER LEGAL THEORY, INCLUDING BUT NOT LIMITED TO LOST PROFITS, DOWNTIME, GOODWILL, OR DAMAGE TO EQUIPMENT AND PROPERTY.

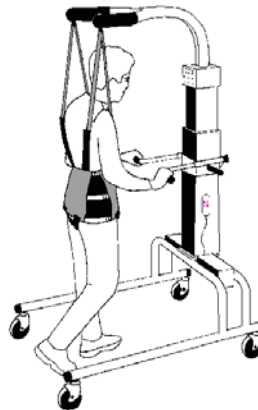

Products, Education, and Rehabilitation Solutions

Mobility Research LLC , P. O. Box 3141 , Tempe AZ 85280

Phone: 1-800-332-9255 / 480-829-1727 Fax: 480-829-0737