



TR Comfortline

Height Adjustable Bathtub

Hygiene Equipment
Designed for People

Operating Manual

Serial Number:



Registered at Medical Products Agency, Sweden, as a MD Class 1 product, MDD 93/42EEC.

TR reserves the right to make design changes and/or improvements without notice.



Always study this manual carefully before you attempt to operate your bathing system. The operator/user must always have access to the operating manual.

This bathing system is intended for professional use only where the patient will be under supervision of trained personnel.

Operating instructions and recommended maintenance procedures are explained in the following pages.

If you have any questions regarding the operation or maintenance of your bathing system and cannot find the answer in this manual, please contact us.

The system is designed for years of trouble free operation, with proper use and maintenance.

Bathtub and shower water must be run at least every three days.

Head Office

TR Equipment AB, Sweden
Phone: +46 140 38 50 60
info@treqipment.se
www.treqipment.com

Group Subsidiaries

TR Group Inc, US, Phone: +1 (800) 752 6900
TR Equipment Ltd, UK, Phone: +44 (0) 844 335 8386
TRanspoRehaMed GmbH, Germany, Phone: +49 (0) 212 645850-0



TR EQUIPMENT



TR Comfortline

Height Adjustable Bathtub

Hygiene Equipment
Designed for People

Table of Contents

Introduction	3
Product Description, Technical Specification and Intended Use	4
Safety Instructions	6
Features and Controls for TR Comfortline	8
Installation Instructions	9
Initialization	13
User Instructions	14
Bathtub cleaning	15
Air Spa System	17
Cleaning Air Spa System	18
LED Color Light System	19
MP3 Sound System	19
Bluetooth and AUX system	22
Autofill	23
System Components	24
Acuators	24
Thermostat	24
Routine Maintenance	25
Labels	26
Maintenance record	27
Training record	27

Head Office

TR Equipment AB, Sweden
Phone: +46 140 38 50 60
info@trequipment.se
www.trequipment.com

Group Subsidiaries

TR Group Inc, US, Phone: +1 (800) 752 6900
TR Equipment Ltd, UK, Phone: +44 (0) 844 335 8386
TRanspoRehaMed GmbH, Germany, Phone: +49 (0) 212 645850-0



TR EQUIPMENT



TR Comfortline

Height Adjustable Bathtub

*Hygiene Equipment
Designed for People*

Introduction

Dear Customer,

Thank you for choosing one of our quality products. We hope you enjoy the Comfortline height adjustable bathtub.

This manual shall, in conjunction with staff training, ensure that the operator/user is always using and/or operating the Comfortline correctly.

TR requires that each user has read and understands the entire operating manual and that they can apply the instructions as specified. This applies to anyone who was not present at the in-service.

This instruction manual should generally be kept easily accessible for every user. Copying the whole manual is encouraged since its sole purpose is to improve the standard of training and safety.

Please order another copy from us if the instruction manual is lost or unusable, or if it has become illegible over time.

If you require further information or have any questions please do not hesitate to contact TR or ask one of our qualified partners.

Please make sure you have read, understood and applied the information on the following pages.

Head Office

TR Equipment AB, Sweden
Phone: +46 140 38 50 60
info@trequipment.se
www.trequipment.com

Group Subsidiaries

TR Group Inc, US, Phone: +1 (800) 752 6900
TR Equipment Ltd, UK, Phone: +44 (0) 844 335 8386
TRanspoRehaMed GmbH, Germany, Phone: +49 (0) 212 645850-0



TR EQUIPMENT

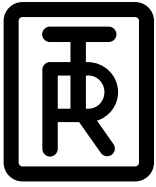

TR Comfortline

Height Adjustable Bathtub

Hygiene Equipment
Designed for People

Product Description, Technical Specifications and Intended Use

“TR Comfortline” is a height adjustable bathtub. The bathtub can be raised and lowered to infinite positions within the height range.

The height adjustable bathtub TR Comfortline is designed for bathrooms in nursing homes, clinics and hospitals and consists of:

1. The tub, side covers and maintenance hatch are made of fiberglass reinforced polyester covering the whole supporting frame and the actuators, control unit and all internal sanitary installations. The ½ inch cold and hot water inlet hoses are located in the back. The maintenance hatch at the back can be removed for repair and maintenance work.
2. The HiLo bathtub can be adjusted between 650 and 1000 mm/26” and 40”.
3. The three-step adjustable foot support is pushed into the slots to accommodate the different lengths of patients and to avoid them from sliding and providing secure support for their feet. The foot support can be removed, for example when using the stretcher.
4. Two built-in handles offer additional support when getting in and out of the tub.
5. Overflow protection and pop-up drain which opens and closes the drainage system by rotating the overflow valve.
6. The thermostat mixer is designed to regulate the water temperature to the bathtub filling spout and to the handheld shower. See separate thermostat mixer operation manual for further information.
7. The shower handle with shower hose is to be used to shower the patient and to rinse equipment after cleaning.
8. Two synchronised actuators with double controls for height adjustment to infinite positions.
9. Two legs including adjustable feet if the floor should be uneven.
10. The hand control with spiral cord is located on the hatch bracket, and is used to raise and lower the tub.

Product Description	Version	Art no
TR Comfortline Height adjustable bathtub (according to above description)		05194000
TR Comfortline Height adjustable bathtub (according to above description)	UK-TMV3	05194001
TR Comfortline Height adjustable bathtub (according to above description)	GE	05194002
TR Comfortline Height adjustable bathtub (according to above description)	UK-TMV2	05194003
TR Comfortline Height adjustable bathtub (according to above description)	110 V	05194004
TR Comfortline Height adjustable bathtub without mixer(according to above description)		05194005
TR Comfortline Height adjustable bathtub (according to above description)	GE-ROHR	05194006
TR Comfortline Height adjustable bathtub (according to above description)	AUS-FMM	05194007
TR Comfortline Fixed height without electric options (powder coated zink plated feet)		05194020
TR Comfortline Fixed height with electric options (powder coated zink plated feet)		05194025

Product Description, options	Art no
Air-Spa system with twelve air nozzles into the bottom of the tub	05195020
LED Light Color System that turns the water into different colors	05195033
Music, sound wave system with four speakers AUX and bluetooth	05195041
Autofill with two different pre-set levels	05195010
Cleaning/disinfection system	05195000
Special Color Bathtub and bathtub side covers in optional RAL - Color (Specify RAL code on order)	05195050

Head Office

TR Equipment AB, Sweden
Phone: +46 140 38 50 60
info@trequipment.se
www.trequipment.com

Group Subsidiaries

TR Group Inc, US, Phone: +1 (800) 752 6900
TR Equipment Ltd, UK, Phone: +44 (0) 844 335 8386
TRanspoRehaMed GmbH, Germany, Phone: +49 (0) 212 645850-0



TR EQUIPMENT

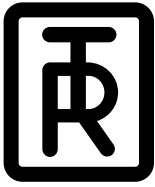

TR Comfortline

Height Adjustable Bathtub

Hygiene Equipment
Designed for People

Technical Specifications

Outside Length	2 080 mm/82"
Outside width	780 mm/31"
Height settings	from 650 - 1000 mm/26" - 40"
Inside length	1 650 mm/65"
Inside width (Head end)	690 mm/27"
Inside width (Foot end)	600 mm/24"
Inside width (tub body)	440 mm/17"
Access height	650 mm/26"
Clearance between the floor and the bottom of the tub	150 mm/6"
Bathtub body material	GRP
Lift stroke	350 mm/14"
Lift speed	8 mm/s/0.5 inch/s
Lifting power per actuator	3000 N/300 Kg
Input current	~ 230 V/50 Hz/10 A ~ 110 V/60 Hz
Control voltage	24 V DC
Overall weight (empty)	appr 100 Kg/220 lbs
Max. total load	Individuals weighing no more than 150 Kg/330 lbs with max. 180 litres/48 gallons of water
Bathtub faucet	See thermostat mixer operating manual
Service life of the actuators according to manufacturer	20 000 lifts or appr. 10 years

Intended Use

- The device "TR Comfortline" is intended for bathing and showering of patients.
- The patient is typically a person who is unable to take care of their own personal hygiene.
- The device is not intended to be used with patients that exceed a weight of 150 kg.
- The device is not intended to come in contact with injured skin.
- The user is any adult person who is capable of reading and understanding the operating manual and is qualified to care for dependent persons/patients.
- Before using the device, the user must read and understand the operating manual.
- The device is intended to be used indoors in all types of care facilities and private homes, including hygiene areas.

Head Office

TR Equipment AB, Sweden
Phone: +46 140 38 50 60
info@trequipment.se
www.trequipment.com

Group Subsidiaries

TR Group Inc, US, Phone: +1 (800) 752 6900
TR Equipment Ltd, UK, Phone: +44 (0) 844 335 8386
TRanspoRehaMed GmbH, Germany, Phone: +49 (0) 212 645850-0



TR EQUIPMENT

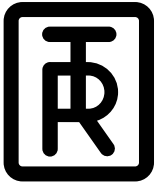

TR Comfortline

Height Adjustable Bathtub

Hygiene Equipment
Designed for People

Safety Instructions

This HiLo bathtub may only be operated by qualified and trained staff.

Please make sure that:

- all safety and operating instructions are read and understood and that they are adhered to and applied when using the bath.
- new colleagues must be trained by qualified and experienced staff.

The bathtub may only be installed and connected according TR Equipment assembly and installation instructions by specialists such as a certified electrical installation company. Local guidelines and regulations, as well as installation rules for water and power connections must be adhered to.

Even if you have chosen TR Equipment to install the bathtub, the cold and hot water supply and the electrical wiring is the buyer's responsibility. Electrical wiring must be carried out on site by a qualified electrician.

The bathtub may only be connected to the power supply via a cord that is connected to a **GFCI (ground fault circuit interrupter)** including an easily accessible switch near the bathtub.

Maintenance work must be carried out by specialist firms or trained staff.

Repairs can only be carried out after consulting the supplier.

Repairs shall only be carried out by specialist firms using original spare parts.

Every time, before the bathtub is used, please make sure that there are no visible damages/defects such as:

- Cracks in the tub body/side covers
- Damages to the mains cord
- Ensure that the bathtub is lowered/raised evenly
- The handles are fastened
- It stands stable
- There are no defects and the thermostat, hand control and option buttons are all working properly

Important: The manufacturer's warranty and liability expire automatically if modifications or repairs are carried out or if components are exchanged or opened without the manufacturer's consent.

Head Office

TR Equipment AB, Sweden
Phone: +46 140 38 50 60
info@trequipment.se
www.trequipment.com

Group Subsidiaries

TR Group Inc, US, Phone: +1 (800) 752 6900
TR Equipment Ltd, UK, Phone: +44 (0) 844 335 8386
TRanspoRehaMed GmbH, Germany, Phone: +49 (0) 212 645850-0



TR EQUIPMENT



TR Comfortline

Height Adjustable Bathtub

Hygiene Equipment
Designed for People

Safety Instructions

If you have a question regarding the operation or maintenance of your TR Comfortline and cannot find the answer in this manual, please contact us.

- Only qualified staff, who understand all operating and safety procedures, may operate the equipment.
- When using the TR 9650 the patient must be seated comfortably on chair and/or stretcher, with **safety belts securely attached**. Safety belts must be maintained in good condition.
- Raise Stretcher/Chair to ensure clearance of all body parts over the tub. The purpose is to avoid the patient from being pinched between the tub rim and the Chair/Stretcher frame during transfer.
- Before raising or lowering the tub, make sure that the patients hands firmly grasp the stabilising bar or that the patients arms are crossed over his/her body. The purpose is to avoid pinched arms or fingers between the Stretcher/Chair frame and the tub rim.
- Wipe beneath Stretcher/Chair to prevent water dripping on the floor.
- Always physically check water temperature before and during bathing/ showering to ensure that the thermoscopic mixer is functioning. The thermostatic mixing valve is pre-set to approximately 43 °C under ideal installation conditions at the factory.
- Make sure that all parts that come in contact with the patient are intact and without sharp edges.
- Check that hoses, tub controls, connections, mixer and thermometer are free from damage.

Warning: Always disconnect electric power before attempting any service or repair.

Warning: Never leave a patient unattended.

Head Office

TR Equipment AB, Sweden
Phone: +46 140 38 50 60
info@trequipment.se
www.trequipment.com

Group Subsidiaries

TR Group Inc, US, Phone: +1 (800) 752 6900
TR Equipment Ltd, UK, Phone: +44 (0) 844 335 8386
TRanspoRehaMed GmbH, Germany, Phone: +49 (0) 212 645850-0



TR EQUIPMENT

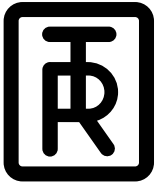

TR Comfortline

Height Adjustable Bathtub

Hygiene Equipment
Designed for People

Features and Controls for TR Comfortline

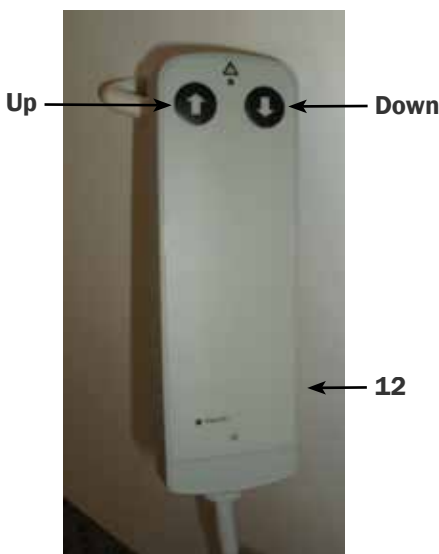

1	Tub side covers
2	Tub
3	Legs
4	Adjustable feet
5	Lifting mechanism (actuators)
6	Light /Music controls
7	Handles
8	Foot support slots
9	Drain plug
10	Thermostat with bathtub filling spout and shower
11	Shower handle
12	Hand control UP/DOWN
13	Overflow drainage and control to open and close drain plug (No 8)
14	Drainage hose



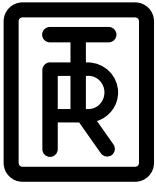

TR Comfortline

Height Adjustable Bathtub

Hygiene Equipment
Designed for People

Installation Instructions

The HiLo bathtub Comfortline is delivered to you fully assembled, ready to be connected to the water and power supply at the customer's premises and should be installed according to local guidelines and regulations. The tub must be cleaned before the first use.

Assembly process:

Do not drag nor push the bathtub across the floor as this could cause damage to the legs or actuators.

When lifted, do so briefly and use at least two people.

1. Once the bathtub is in its final position, lift briefly at each end again to release any tensions that might have been created between the feet during installation.
2. The adjustable feet are used to level/adjust the bathtub. Please bear in mind that the head end of the bathtub has to be approx. 2 cm/3/4" higher than the foot end to allow the water to drain more easily.
3. Please flush the premises pipework before connecting the Comfortline to protect the bathtub fittings from dirt.
4. A certified electrician shall connect the mains cord to a wall-mounted outlet (splashproof) in accordance with local regulations.
5. Use the flexible drain hose to establish a connection between the drain siphon (at the bottom of the tub) and the floor gully. This connection is best attached when the bathtub is raised into its highest position.
6. Carry out functional test:
Test the Up/Down function by pushing each button on the hand control. **Initialization** must be carried out if the tub does not raise evenly (see separate instruction in the manual).
7. Check that the thermostat is working properly and test the water temperature! If the temperature is not the same as the actual water temperature, adjust according to manufacturer's instructions! (see separate thermostat mixer operating manual).
Always physically check water temperature before and during bathing/ showering to ensure that the thermoscopic mixer is functioning. The thermostatic mixing valve is pre-set to approximately 43°C under ideal installation conditions at the factory.
8. Check that the bath tap and the shower work properly.
9. Check the cold/hot water connections and make sure the drain hose is intact.
10. Make sure the mains cord is attached correctly and that it is not damaged.

The bathtub may only be used after it has been successfully and correctly installed.

On-site preparations:

1. 3/4 inch hot and cold water connection, stopcock with a 1/2 inch external thread for connecting nut (on-site pre-shutoff device) incoming water pressure 1-5 bar
2. Mains connection 230 V/50 Hz, 10 A. or 110 V/60 Hz depending on model

Note: All electrical conduit, fitting and wiring to bath supplied and installed by a certified electrician in accordance with local or applicable electric code as a minimum requirement. Main switch with signal lamp, main fuse and earth circuit breaker are not included and must be supplied by others.

Installation of Thermostatic Mixer

1. Rinse pipes according to DIN 1988
2. Attach connections to the water supply.
3. The hot water supply has to be on the left and the cold water supply must be on the right side. Check the connections for any leaks and make sure the fittings are working properly.

Installation drawing for HiLo bathtub Comfortline

Floor drainage - Open floor drain Or HI pipe DN40/50 (pipe coupling).

Wall drainage - HI pipe DN40/50 (pipe coupling)

Head Office

TR Equipment AB, Sweden
Phone: +46 140 38 50 60
info@trequipment.se
www.trequipment.com

Group Subsidiaries

TR Group Inc, US, Phone: +1 (800) 752 6900
TR Equipment Ltd, UK, Phone: +44 (0) 844 335 8386
TRanspoRehaMed GmbH, Germany, Phone: +49 (0) 212 645850-0



TR EQUIPMENT



TR Comfortline

Height Adjustable Bathtub

Hygiene Equipment
Designed for People

Installation Instructions

Installation drawing for HiLo bathtub Comfortline

Floor drainage - Open floor drain Or HI pipe
DN40/50 (pipe coupling).
Wall drainage - HI pipe DN40/50
(pipe coupling)

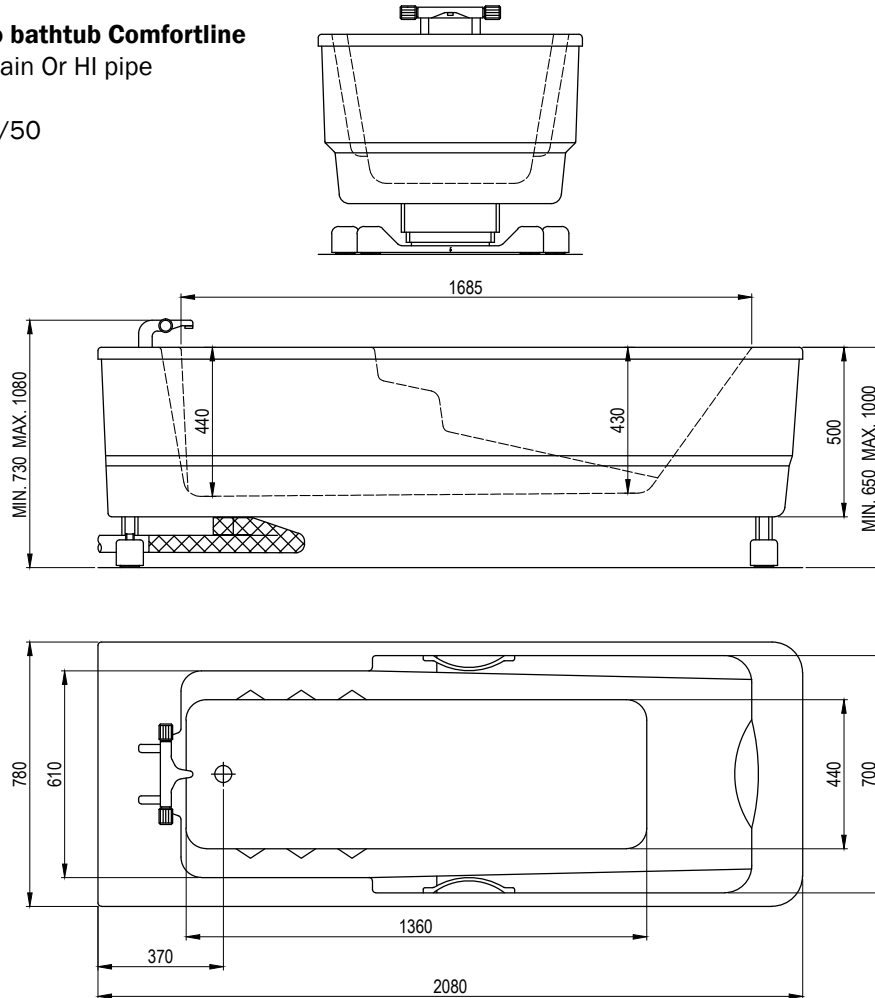

Floor Drainage Installation

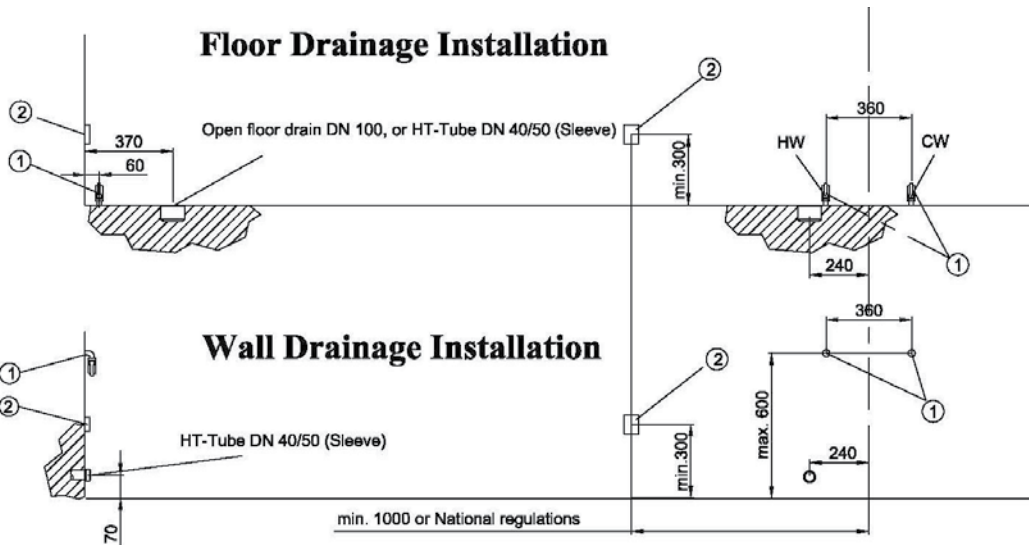

Wall Drainage Installation

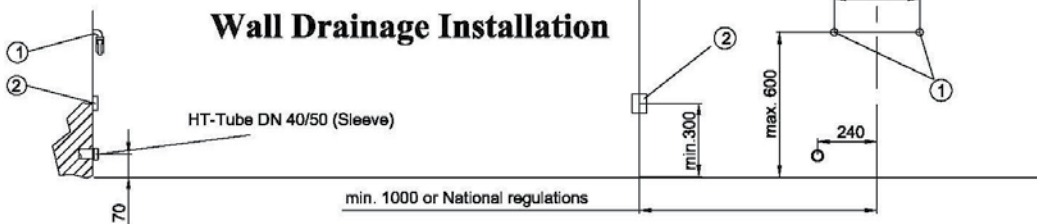

Head Office
TR Equipment AB, Sweden
Phone: +46 140 38 50 60
info@trequipment.se
www.trequipment.com

Group Subsidiaries
TR Group Inc, US, Phone: +1 (800) 752 6900
TR Equipment Ltd, UK, Phone: +44 (0) 844 335 8386
TRanspoRehaMed GmbH, Germany, Phone: +49 (0) 212 645850-0



TR EQUIPMENT



TR Comfortline

Height Adjustable Bathtub

Hygiene Equipment
Designed for People

Installation Instructions

Assembly of the cleaning system

Valve

- A. Assemble the valve stem (1) by screwing it into the left female threaded coupling No.1. on the bathtub.
- B. Screw on the protective sleeve (2) onto the valve stem (1).
- C. Push on the chromed ring (3) over the protective sleeve (2).
- D. Finally screw on the key (4) onto the completed valve.



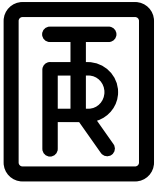

TR Comfortline

Height Adjustable Bathtub

Hygiene Equipment
Designed for People

Installation Instructions

Assembly of the cleaning system

The Cleaning handshower holder.

- Assemble the 90 degree elbow (1) by screwing it into the right female threaded coupling No. 2. on the bathtub.
Seal with sealing tape.
- Mount the handshower holder (2) over the 90 degree elbow (1) and fasten it with the supplied screw.
- Finally screw the pipe interrupter (3) onto the 90 degree elbow (1).



Head Office

TR Equipment AB, Sweden
Phone: +46 140 38 50 60
info@treqquipment.se
www.treqquipment.com

Group Subsidiaries

TR Group Inc, US, Phone: +1 (800) 752 6900
TR Equipment Ltd, UK, Phone: +44 (0) 844 335 8386
TRanspoRehaMed GmbH, Germany, Phone: +49 (0) 212 645850-0



TR EQUIPMENT

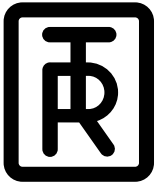

TR Comfortline

Height Adjustable Bathtub

Hygiene Equipment
Designed for People

Initialization Actuators

An initialisation should be carried out the very first time the bathtub is started-up and after every power failure.

Should be performed after/when:

- First time Start-up
- Power failure (power cut, disconnection from supply or shutdown)

Reason:

The initialization function (continuous movement monitoring) is designed with safety and the protection of the equipment/user in mind. The control switches off automatically if one of the actuators is working faster than the other one.

New control box from July 1, 2013:

Please press and hold both the UP and **down** button simultaneously on the hand control to initialize the control mechanism. After about 10-12 seconds you will hear a “click” sound from the control box and after about 5 seconds more, you will hear an audible tone from the control box. Keep pressing both the UP and **down** button and the actuators will now move to their highest position. When the actuators have reached the highest position you will again hear an audible tone and then the system is ready to be used.

Old control box used until June 2013:

Please press the **down** key on the handcontrol to initialize the control mechanism. When you reach the lowest position, keep the **down** button pressed for another 5 seconds and then an audible tone sounds and the system is ready to be used.

Please do not hesitate do contact us if you have any further queries.

Head Office

TR Equipment AB, Sweden
Phone: +46 140 38 50 60
info@trequipment.se
www.trequipment.com

Group Subsidiaries

TR Group Inc, US, Phone: +1 (800) 752 6900
TR Equipment Ltd, UK, Phone: +44 (0) 844 335 8386
TRanspoRehaMed GmbH, Germany, Phone: +49 (0) 212 645850-0



TR EQUIPMENT

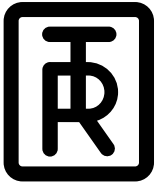

TR Comfortline

Height Adjustable Bathtub

Hygiene Equipment
Designed for People

User Instructions

Using the bath

- The drain plug closes (and opens) by turning the overflow valve.
- Adjust the thermostat to required temperature (see separate thermostat mixer operating manual). Open the thermostat and **test the water temperature by hand or with a bath thermometer**. Fill the bath to the required level and close the thermostat.

Important: Always check the water temperature by hand or a bath thermometer before the patient gets into the bath. The thermostatic mixing valve is pre-set to approximately 43°C under ideal conditions at the factory.

- Lower the tub to the lowest position with the hand control allowing the patient to step into the bath with assistance. **(Place the hand control back into its bracket at the back of the tub after use)**. The built-in handles provide the patient with extra support.
- When the patient is assisted into the bath with a lift system, the lifter must be positioned close to the side of the bathtub. The bathtub should be in a convenient working height and be adjusted by pressing the relevant button on the hand control **(Place the hand control back into its bracket at the back of the tub after use)**.

Please make sure that the bathtub is lowered and raised evenly, both at the head and foot end of the tub! The tub must be level at all times. The patient must not use the bath if it is not level!

- The foot support shall be removed before the lift stretcher is lowered into the water. It can be placed into the required position when a chair lift is used.

The shower handle is used to shower the patient and to rinse equipment after cleaning. Pull the diverter knob on the thermostat. This diverts the water from the bath filling spout to the shower handle. **Always test the water temperature by hand to prevent patients from being scalded or shocked by cold/hot water.**

Head Office

TR Equipment AB, Sweden
Phone: +46 140 38 50 60
info@trequipment.se
www.trequipment.com

Group Subsidiaries

TR Group Inc, US, Phone: +1 (800) 752 6900
TR Equipment Ltd, UK, Phone: +44 (0) 844 335 8386
TRanspoRehaMed GmbH, Germany, Phone: +49 (0) 212 645850-0



TR EQUIPMENT



TR Comfortline

Height Adjustable Bathtub

Hygiene Equipment
Designed for People

User Instructions - Bathtub Cleaning

Important: Never to be used on patients. Only on equipment.

The cleaning detergent is automatically mixed with cold water, in a pre-set concentration of appr. 2 % to minimize inhalation.

Use only **liquid, non-abrasive, non-scouring**, commercially available detergents to clean the bathtub, the controls and the foot support! Apply the detergent according to the detergent supplier's instructions.

Fittings: Plated as well as color coated surfaces can get damaged by acidic and abrasive detergent and scouring pads. We recommend clear water and a soft cloth. If the fittings are heavily soiled, clean with soapy water or vinegar and rinse with clear water and rub dry.

Important: The user/operator is responsible for selecting the detergents and bath additives. Please read the detergent supplier's instruction manual and find out whether the product is suitable.

Head Office

TR Equipment AB, Sweden
Phone: +46 140 38 50 60
info@trequipment.se
www.trequipment.com

Group Subsidiaries

TR Group Inc, US, Phone: +1 (800) 752 6900
TR Equipment Ltd, UK, Phone: +44 (0) 844 335 8386
TRanspoRehaMed GmbH, Germany, Phone: +49 (0) 212 645850-0



TR EQUIPMENT

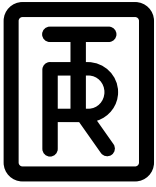

TR Comfortline

Height Adjustable Bathtub

Hygiene Equipment
Designed for People

User Instructions - Bathtub Cleaning

Fill the container:

Remove the container lid **(1)** and pour the detergent into the opening using a funnel **(Maximal 1.5 Litres/1/3 gallon)**. Replace the lid after the container has been filled **(1)**. The detergent device is now ready for use.

Cleaning:

You may use your usual detergent to clean the bathtub. Please make sure you have read the **detergent supplier's instructions**.

Daily use of the cleaning system:

1. Remove the cleaning spray handle (2) from bracket (3). Hold the handle over the bathtub while opening the shut-off safety valve (4) with the special key.
2. Briefly spray the cleaning mixture into the tub while checking the color, smell and the foam of the mixture. Spray over all interior surfaces of the tub. Remove residue and debris with cloth or brush.
3. To clean TR Chair Lift and Stretcher Lift, position them over the tub and spray them with cleaning mixture. The Chair and Stretcher have removable pads and the Stretcher has a head pillow which can be placed in the tub for cleaning.
4. After cleaning, rinse with fresh water using the shower handle.

Note: It will take a little longer for the detergent to be dispersed if it is the first time the bathtub is started-up or if the container has just been filled.

Warning: Always read and apply the detergent supplier's safety instructions!

Warning: Avoid skin or eye contact with cleaning/detergent, which can be highly corrosive. If contact is made, rinse immediately with excess water. If irritation occurs, consult a doctor. Always read and follow detergent supplier directions carefully.



Head Office

TR Equipment AB, Sweden
Phone: +46 140 38 50 60
info@trequipment.se
www.trequipment.com

Group Subsidiaries

TR Group Inc, US, Phone: +1 (800) 752 6900
TR Equipment Ltd, UK, Phone: +44 (0) 844 335 8386
TRanspoRehaMed GmbH, Germany, Phone: +49 (0) 212 645850-0



TR EQUIPMENT

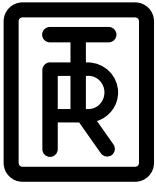

TR Comfortline

Height Adjustable Bathtub

Hygiene Equipment
Designed for People

User Instructions - Air Spa

Air spa system - Esprit 500 (Option)

Note: The operating time is restricted for safety reasons. The system (air system) switches off automatically after 30 minutes.

Stand-by LED

If the bathtub is connected to mains, but there is not enough water in the bathtub, the LED (0.1) flashes.

As soon as the water level sensor detects water, the LED (0.1) is illuminated.

Air Spa system

Use button 1 "ON/OFF" to turn the system on and off (LED 1.1) is illuminated when system is on. The Air Spa system starts at a medium intensity level.

Setting the intensity level

- Pressing button 2 "+" (Plus) increases intensity, LED (2.1) is illuminated. The LED is illuminated as long as the button is pressed, or if the maximum intensity is reached and the button is not pressed anymore.
- Pressing button 3 "-" (Minus) reduces intensity, LED (3.1) is illuminated. The LED is illuminated as long as the button is pressed, or if the minimum intensity is reached and the button is not pressed anymore.

Interval and Pulse function

- Pressing + and - at the same time for about 3 seconds, starts the interval function. (The blower will run from minimum to maximum intensity every 20 seconds.)
- Pressing + and - at the same time for about 3 seconds a second time, starts the pulsation function. (The blower is automatically started and stopped about every 3 seconds.)
- Pressing + and - at the same time for about 3 seconds for the third time, returns the system to normal state.

Dry Blowing function

The dry blowing starts 10 min. after the water level sensor does not detect water in the bathtub.

The dry blowing lasts for approximately 2 minutes.

The LED (1.1) is flashing during the 10 min. waiting time.

Note: For safety reasons the Air Spa System automatically turns off after 30 minutes of use. To restart the Air Spa System press 1 "ON/OFF".

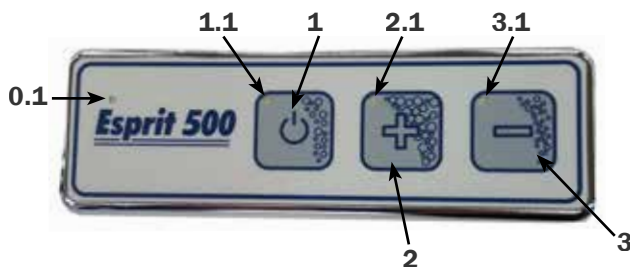

Head Office

TR Equipment AB, Sweden
Phone: +46 140 38 50 60
info@trequipment.se
www.trequipment.com

Group Subsidiaries

TR Group Inc, US, Phone: +1 (800) 752 6900
TR Equipment Ltd, UK, Phone: +44 (0) 844 335 8386
TRanspoRehaMed GmbH, Germany, Phone: +49 (0) 212 645850-0



TR EQUIPMENT



TR Comfortline

Height Adjustable Bathtub

Hygiene Equipment
Designed for People

Cleaning the Air Spa System

The Air Spa system on the TR Comfortline and TR 1700 utilizes a blower that generates air bubbles through small air jets in the bottom of the bathtub.

The air jets have integral check valves. The check valves open and close when the blower is turned on or off. The internal check valve keeps water out of the air system, insuring a clean and dry system.

Important: The Air Spa system also has a dry-blowing function that starts 10 minutes after the water level sensor does not detect water in the bathtub. This function will purge any remaining water from the air jets.

Cleaning the bathtub

1. Drain the water from the bathtub and remove any visible debris. **Wait until the dry-blowing function is finished.**
2. Clean the surfaces of the bathtub with soap or detergent, rinse with clean water, and drain.
3. After cleaning, disinfect the surfaces with disinfectant according to the manufacturer's directions on the label. Surfaces must remain wet with the disinfectant according to the manufacturer's specification.
4. After disinfection, drain and rinse with clean water.
5. More rarely, but if necessary after severe contamination, you can also unscrew the chrome caps on the air jets by hand to disinfect underneath the chrome caps and also into the air jet. See photos below.

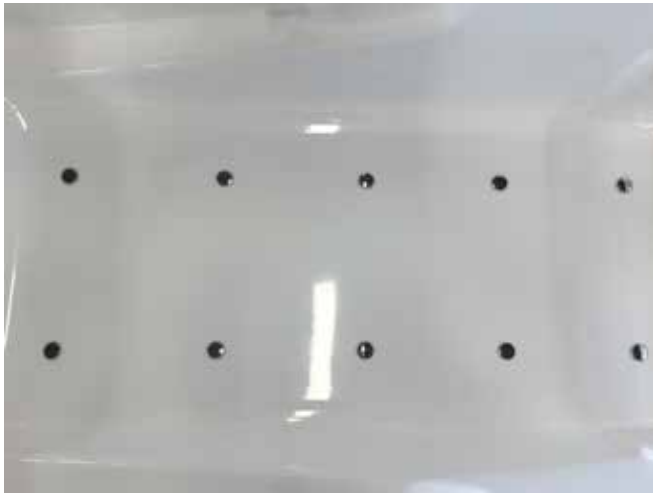

Important: After using the Air-spa system ensure that the chrome plated covers over each jet outlet are finger tight as these can work loose over extended use of the Air-Spa system.

Head Office

TR Equipment AB, Sweden
Phone: +46 140 38 50 60
info@treqquipment.se
www.treqquipment.com

Group Subsidiaries

TR Group Inc, US, Phone: +1 (800) 752 6900
TR Equipment Ltd, UK, Phone: +44 (0) 844 335 8386
TRanspoRehaMed GmbH, Germany, Phone: +49 (0) 212 645850-0



TR EQUIPMENT



TR Comfortline

Height Adjustable Bathtub

Hygiene Equipment
Designed for People

User Instructions - LED Light System

**LED Color Light System (option),
from 2016-10-10 and forward. Serial no: 1610-203483-1**

Use:

The light system touch control is located either at the head end (on the side of the tub covers) or at the foot end (on the edge of the tub, depending on bathtub model).

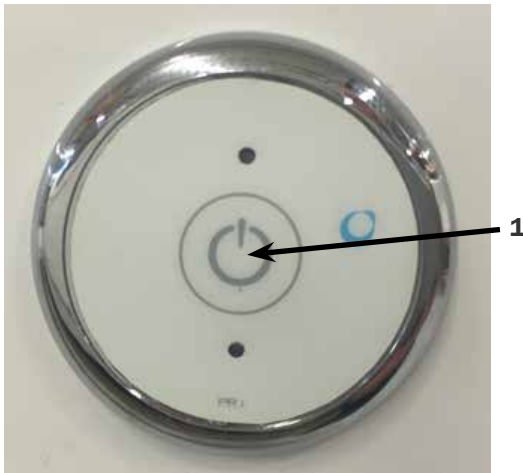

1. The light system is turned ON and OFF by pressing the power switch button (1). Diode signals that the system is in operation.
2. The light-system option allows the user to choose a particular color, which will illuminate the water via built-in floodlight until the system is turned off again. An individual color can be selected by pressing button (1) several times.
3. Press once for White color, press twice for Red color, third press for Green color, fourth press for Blue color, fifth press for Yellow color, sixth press for RGB multi color.
4. When RGB multi color is activated the system automatically rotates between the different colors.
5. Press button (1) for 2 seconds to turn the system OFF.

Head Office

TR Equipment AB, Sweden
Phone: +46 140 38 50 60
info@trequipment.se
www.trequipment.com

Group Subsidiaries

TR Group Inc, US, Phone: +1 (800) 752 6900
TR Equipment Ltd, UK, Phone: +44 (0) 844 335 8386
TRanspoRehaMed GmbH, Germany, Phone: +49 (0) 212 645850-0



TR EQUIPMENT

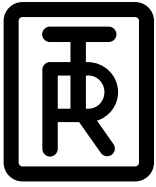

TR Comfortline

Height Adjustable Bathtub

Hygiene Equipment
Designed for People

User Instructions - MP3 Sound System

MP3-Sound-System (Option) Before 2012-03-31

Use:

The sound system touch control is located either at the head end (on the side of the tub covers) or at the foot end (on the edge of the tub, depending on bathtub model).

Operating Instructions

- To start the music, press button (1). Press button (2) if you want to turn the music off.
- The volume can be turned up and down with the buttons (3) and (4). Press and hold button (3) for a few seconds to increase the volume and button (4) to decrease it.
- Switch between tracks by briefly pressing button (3 - next track) and (4 - previous track).

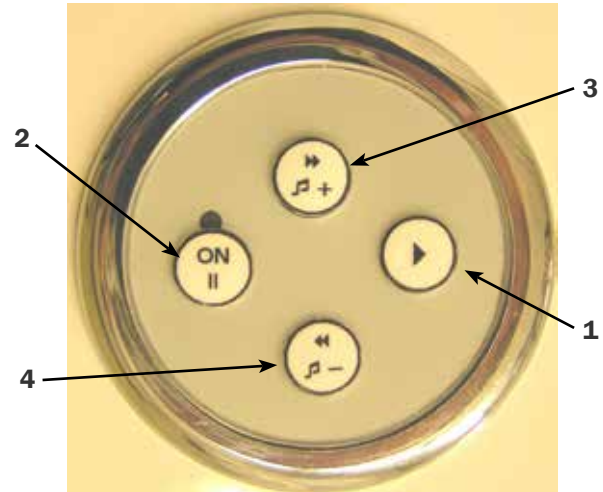

General Information:

The control box for the MP3 sound system is attached at the bottom of the tub. MMC-, as well as SD memory cards up to 1 GB can be used. (Please adhere to the general copyright regulations of the music played).

Note: Always switch off the mains before changing the SD card.

To change/remove the SD memory card, move the bathtub into its highest position for better access to the control box. The memory card can be pulled from the card slot (1) after the control box lid has been removed. Now you can save the music you would like to listen to onto the memory card (observe copyright).

The memory card supplied contains a control file **Config.txt**. This file must not be deleted because it is necessary for the MP3 player to function properly.

The music saved on the card must be in MP3 format and must not be saved in sub-folders/directories because the player will not recognise them and will therefore not play them. After saving the music onto the memory card, place it back into the card slot (1) and put the lid to the control box back on. The MP3 sound system is ready for use after the bathtub mains has been switched on again.

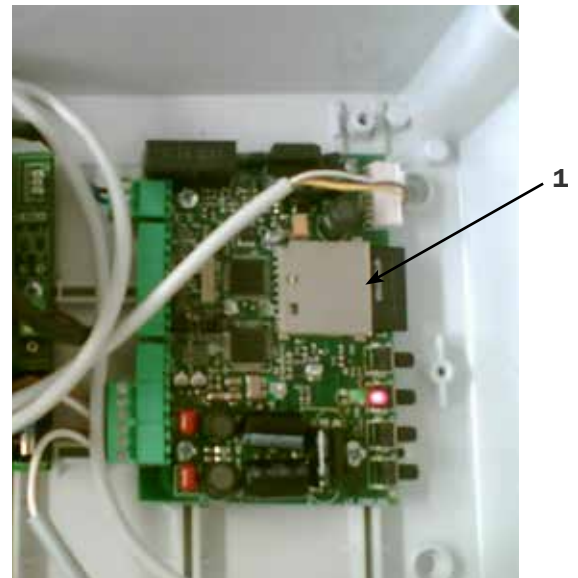

Head Office

TR Equipment AB, Sweden
Phone: +46 140 38 50 60
info@trequipment.se
www.trequipment.com

Group Subsidiaries

TR Group Inc, US, Phone: +1 (800) 752 6900
TR Equipment Ltd, UK, Phone: +44 (0) 844 335 8386
TRanspoRehaMed GmbH, Germany, Phone: +49 (0) 212 645850-0



TR EQUIPMENT

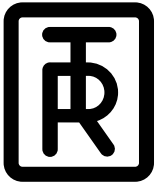

TR Comfortline

Height Adjustable Bathtub

Hygiene Equipment
Designed for People

User Instructions - MP3 Sound System

MP3-Sound-System (Option) After 2012-04-01

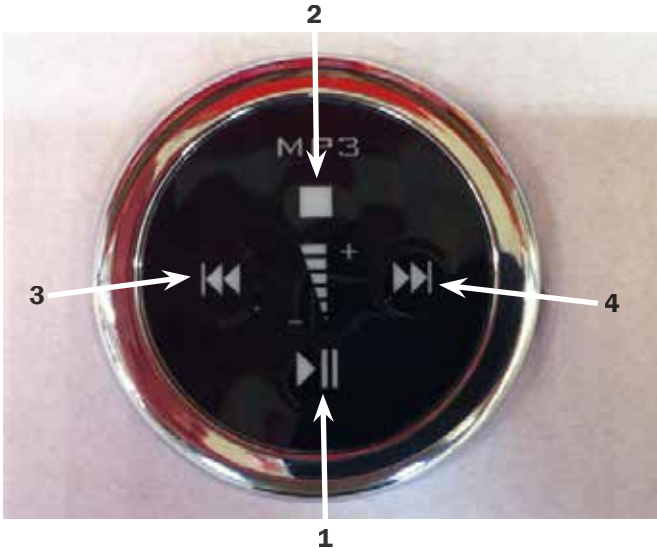

- 1 = Play/Pause
- 2 = STOP
- 3 = Previous track
- 4 = Next track

Operating Instruction:

- To start the music, press button (1).
Press button (2) if you want to turn OFF the music.
- The volume can be turned up and down with the buttons (1) and (2).
Press and hold button (1) for a few seconds to decrease the volume and button (2) to increase the volume.
- Switch between tracks by briefly pressing button (3-previous track) and (4-next track).

General information:

A high speed 2GB USB Memory 2.0 is included in the MP3 System (6).

The music saved on the USB Memory should be in MP3 format and must not be saved in sub-folders/directories because the player will not recognize them and can therefore not play them.

After saving the music onto the USB Memory, just place it back into the USB Jack and then the MP3 sound system is ready for use. (Please adhere to the general copyright regulations of the music played).

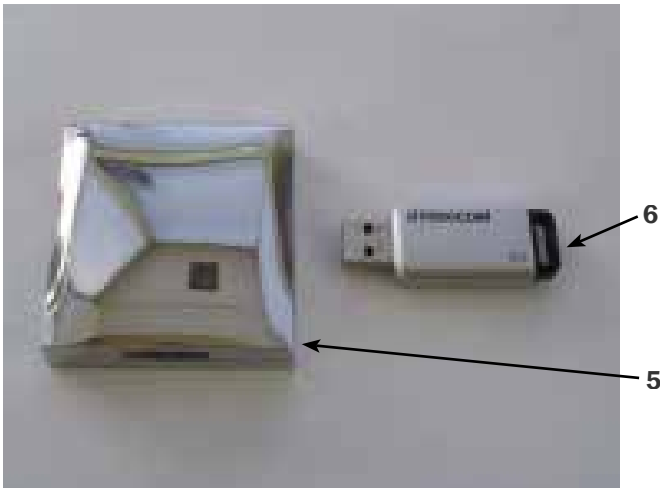

- 5 = Chrome Cover for the USB Jack
- 6 = High speed 2GB USB Memory 2.0

Use:

The sound system touch control and the USB Jack holder (5) are located at the head end of the bathtub. (on the side of the bathtub cover).

Head Office

TR Equipment AB, Sweden
Phone: +46 140 38 50 60
info@trequipment.se
www.trequipment.com

Group Subsidiaries

TR Group Inc, US, Phone: +1 (800) 752 6900
TR Equipment Ltd, UK, Phone: +44 (0) 844 335 8386
TRanspoRehaMed GmbH, Germany, Phone: +49 (0) 212 645850-0



TR EQUIPMENT

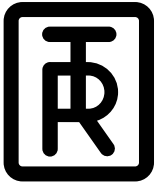

TR Comfortline

Height Adjustable Bathtub

Hygiene Equipment
Designed for People

User Instructions - Bluetooth and AUX system

Operating instructions Bluetooth:

- When the bathtub is connected to power the Bluetooth Music receiver is discoverable.
- Turn on Bluetooth on your smartphone or other device enabled with Bluetooth technology. See manual for your smartphone or other device to see how it's done.
- Connect your smartphone or other device enabled with Bluetooth technology to "Belkin SongStream BT".
- Enter "0000" if your device asks for a PIN code. You only have to enter the PIN code once.
- The Bluetooth Music Receiver can only be connected and play music from one device at a time.

General information:

Keep in mind that the Bluetooth Music Receiver has a 30-foot range (10 m). Please adhere to the general copyright regulations of the music played.

Operating instructions AUX:

- Pull out the plastic cover to the AUX input on the Comfortline bath.
- Use an audio cable with 3,5 mm connection to connect your smartphone or other device enabled with a 3,5 mm connection to the Comfortline bath.



Head Office

TR Equipment AB, Sweden
Phone: +46 140 38 50 60
info@trequipment.se
www.trequipment.com

Group Subsidiaries

TR Group Inc, US, Phone: +1 (800) 752 6900
TR Equipment Ltd, UK, Phone: +44 (0) 844 335 8386
TRanspoRehaMed GmbH, Germany, Phone: +49 (0) 212 645850-0



TR EQUIPMENT



TR Comfortline

Height Adjustable Bathtub

Hygiene Equipment
Designed for People

User Instructions - Autofill

Autofill (Option)

The Autofill allow staff to pick up and prepare the patient for bathing while the tub is pre-filled.

General Information

The touch control for the Autofill is located on rear rim.

Operation/Handling

- (1) Bath filling
- (2) Handshower



Bath filling:



- Press the bath filling symbol (1) and set the thermostat to required temperature. Test the water temperature with your hand or with a bath thermometer.
- The solenoid valves open and the tub will be pre-filled with water up to the lower level sensor. In the meantime the patient can be transferred to the bath. The bath is now ready for the patient to be positioned in the tub. When the patient wants or requires more bathing water, press the bath filling symbol (1) once more. The filling will stop when the water level reaches the second level sensor (just below overflow drainage).
- The Autofilling can be stopped at any time by pressing the bath filling symbol (1)

Handshower:



- Press the handshower symbol (2)
- Water will run from mixer faucet into tub. Pull the diverter knob on faucet to activate the handshower. To turn off the shower, press the Handshower symbol (2)

Note: Always use symbol 1 for tub filling and symbol 2 for shower. Always check the water temperature with a thermometer or physically by hand. Never leave the patient unattended during the entire bathing cycle.

Head Office

TR Equipment AB, Sweden
Phone: +46 140 38 50 60
info@trequipment.se
www.trequipment.com

Group Subsidiaries

TR Group Inc, US, Phone: +1 (800) 752 6900
TR Equipment Ltd, UK, Phone: +44 (0) 844 335 8386
TRanspoRehaMed GmbH, Germany, Phone: +49 (0) 212 645850-0



TR EQUIPMENT

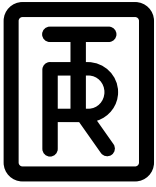

TR Comfortline

Height Adjustable Bathtub

*Hygiene Equipment
Designed for People*

System Components

Actuators

Note: Only company engineers and/or trained staff are authorized to carry out any work on the drive system (actuators). Do not attempt work on the actuators without consulting TR Equipment as this will void the warranty!

Thermostatic Mixer

See separate operating manual, TR refers to the separate operating manual for the thermostatic mixer that was delivered together with the bath.

For Routine Maintenance see page 25 in this operating manual and also the supplier's manual on the thermostatic mixer.

Head Office

TR Equipment AB, Sweden
Phone: +46 140 38 50 60
info@trequipment.se
www.trequipment.com

Group Subsidiaries

TR Group Inc, US, Phone: +1 (800) 752 6900
TR Equipment Ltd, UK, Phone: +44 (0) 844 335 8386
TRanspoRehaMed GmbH, Germany, Phone: +49 (0) 212 645850-0



TR EQUIPMENT

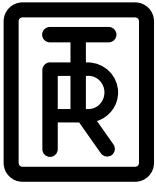

TR Comfortline

Height Adjustable Bathtub

Hygiene Equipment
Designed for People

Routine Maintenance (Also see separate operating manual for thermostatic mixer)

Before each time the bathtub is used:

- Visual inspection - make sure that all electrical cords are in good condition and hoses do not leak
- Make sure it stands securely on the floor
- Check the temperature setting by hand or with a bath thermometer

Daily Maintenance

- Clean the tub after every use.
- Check the cleaning supply at least daily, depending on the frequency of use.
- Avoid abrasive cleaners which may scratch the gel coat finish of the fiberglass bathtub and the panel.
- When the tub is not in use, lower it to its lowest position and make sure all valves are closed.
- Clean the strainers on the patient- and cleaning shower handles by rubbing it with your thumb.
- Visually inspect the tub interior to make sure there are no nicks or cracks which may scratch the patient.

Monthly: (on-site engineer or trained staff)

- Make sure the connecting hot/cold water hoses are fitted correctly and do not leak
- Check all screws and bolts
- Check the power connection cord for damages (current & potential equalization)
- Exercise the thermostatic mixing valve
- For maintenance instructions see enclosed manual from the manufacturer of the thermostatic mixer

Monthly: using the FMM9000E Antibactus Mixer

- Flush the thermostatic mixer according to the local recommendations for your country.

Warning: Risk of scalding when flushing with hot water.

Important: The hoses on the Comfortline bathtub manage maximum 60° for 10 minutes.

Annually:

Maintenance and inspection by the manufacturer or QUALIFIED STAFF authorized by the manufacturer

- Movable components have to be maintained and inspected regularly because they are classified as wear parts! (e.g. motor, fittings, hoses, connections, pipe interrupters, thermostatic mixing valve)
- Inspection of electrical installation and equipment according to local requirements should be carried out annually.

Every 3-5 years:

- Exchanging/replacing all connecting hot/cold water hoses
- For maintenance for critical components of the thermostatic mixer see enclosed manual from the manufacturer of the thermostatic mixer

After appr. 12 years:

- TR recommends that both actuators and control system are replaced

Maintenance and/or repairs may only be carried out by the MANUFACTURER or qualified staff authorized by the manufacturer. Otherwise the guarantee expires immediately.

Note: Iodine, bromine, and methylene blue can discolor the fiberglass.

The recommended frequency of these maintenance procedures will depend on the hardness of your water supply and how often the equipment is used. It is good practice to establish these routine procedures on a weekly basis and then adjust the frequency as your conditions indicate.

All mechanical parts inside the bathtub panel are maintenance free.

Warning: The equipment must not be used in any way that varies from the safety precautions and operating procedures detailed in this manual. The equipment must not be operated by anyone until the user has read and understands the operating manual.

Head Office

TR Equipment AB, Sweden
Phone: +46 140 38 50 60
info@trequipment.se
www.trequipment.com

Group Subsidiaries

TR Group Inc, US, Phone: +1 (800) 752 6900
TR Equipment Ltd, UK, Phone: +44 (0) 844 335 8386
TRanspoRehaMed GmbH, Germany, Phone: +49 (0) 212 645850-0



TR EQUIPMENT











TR Comfortline

Height Adjustable Bathtub

Hygiene Equipment
Designed for People

Labels on the Comfortline

1.		Maximum working load	7.		Filling disinfectant. Maximum 0,4 gallon
2.		Mandatory to read the operating manual before use			TR Equipment AB Logotype
3.		Specifies the maximum pressure for cold water			The identification label states the product's model- and part number, serial number, date of manufacture, the manufacturing country and the name and address of the manufacturer. REF = Model- and part number CE = CE marking in accordance with the Medical Devices Directive 93/42/EEC as a Medical Device Class 1. SN = Serial number
4.		Specifies the maximum pressure and temperature for the hot water			
5.		Specifies the maximum pressure of the separate cold water for disinfection system			
6.		Shower head for disinfection			





TR Comfortline

Height Adjustable Bathtub

Hygiene Equipment
Designed for People

Maintenance records

Date	Description	Signed by

Training records

Date	Description	Signed by

Head Office
TR Equipment AB, Sweden
Phone: +46 140 38 50 60
info@trequipment.se
www.trequipment.com

Group Subsidiaries
TR Group Inc, US, Phone: +1 (800) 752 6900
TR Equipment Ltd, UK, Phone: +44 (0) 844 335 8386
TRanspoRehaMed GmbH, Germany, Phone: +49 (0) 212 645850-0



TR EQUIPMENT