



Avantgarde 4

EN Instructions for use (user) 3

Table of contents

EN

1	Foreword	5
2	Product description	5
2.1	Function	5
2.2	Product Overview	6
3	Safety	7
3.1	Explanation of warning symbols	7
3.2	Safety Instructions for Use	8
3.3	Further information.....	11
3.4	Nameplate and warning labels	12
3.4.1	Nameplate.....	12
3.4.2	Warning labels	12
4	Delivery	12
4.1	Scope of delivery	12
4.2	Options	12
4.3	Storage.....	12
4.3.1	Storage during daily use	12
4.3.2	Storage during extended disuse.....	12
5	Preparation for use	13
5.1	Assembly	13
6	Use	14
6.1	Techniques for using a wheelchair	14
6.2	Further instructions for use.....	14
6.3	Getting in and transferring	15
6.4	Legrests	16
6.4.1	Attaching/removing the legrests	16
6.4.2	Folding the footplate up and down	17
6.5	Seat cushion and back upholstery	18
6.6	Side panels	18
6.6.1	Adjusting the armrest height	18
6.6.2	Removing the side panels	18
6.7	Push handles.....	19
6.7.1	Adjusting the push handles	19
6.8	Rear wheels	19
6.8.1	Removing/mounting the rear wheels	20
6.9	Caster wheels and caster forks.....	21
6.9.1	Approach in case of stiffness	21
6.10	Wheel locks	21
6.10.1	Using the wheel locks.....	21
6.10.2	Using the knee lever wheel lock for user and attendant	22
6.11	Anti-tipper/tip-assist	22
6.11.1	Activating and deactivating the anti-tipper	23
6.11.2	Using the tip-assist.....	24
6.12	Transport wheels	24
6.12.1	Using the transport wheels	24
6.13	Lap belt	25
6.14	Additional options	25
6.15	Disassembly and transport	25
6.16	Use in vehicles for transporting persons with reduced mobility.....	26
6.16.1	Avantgarde DV/DS without CLT option	26
6.16.1.1	Required accessories	27
6.16.1.2	Installation.....	27
	Using the product in the vehicle	27
	Restrictions for use	28

6.16.2	CLT option	29
6.17	Care.....	29
6.17.1	Cleaning	29
6.17.1.1	Cleaning Seat Cushions	29
6.17.1.2	Cleaning belts	30
6.17.2	Disinfection	30
7	Maintenance and repair	30
7.1	Maintenance.....	30
7.1.1	Maintenance intervals	31
7.1.2	Maintenance tasks	31
7.2	Repair	31
7.2.1	Inner tube, rim tape and tyre replacement	31
8	Disposal	33
8.1	Disposal Information.....	33
9	Legal information	33
9.1	Liability	33
9.2	CE Conformity.....	33
9.3	Warranty	33
9.4	Service Life	33
9.5	Trademarks	33
10	Technical data	33
11	Appendices	34
11.1	Threshold values for wheelchairs transportable by train	34

1 Foreword

INFORMATION

Last update: 2016-12-13

- ▶ Please read this document carefully before using the product.
- ▶ Follow the safety instructions to avoid injuries and damage to the product.
- ▶ Have yourself instructed by qualified personnel in the proper and safe use of the product.
- ▶ Please keep this document in a safe place.

INFORMATION

- ▶ New information regarding product safety and product recalls can be obtained from the Customer Care Center (CCC) at oa@ottobock.com or from the manufacturer's service department (see inside back cover or back page for addresses).
- ▶ You can request this document as a PDF file from the Customer Care Center (CCC) at oa@ottobock.com or from the manufacturer's service department (see inside back cover or back page for addresses). It is possible to increase the display size of the PDF document.
- ▶ For further questions about the instructions for use, please contact the qualified personnel who issued the product to you.

You have purchased a high-quality product which can be put to versatile, daily use at home and outdoors.

In order to exclude injuries of any type, familiarise yourself with the handling, functions and use of the product before using it. These instructions for use provide the necessary information.

Please note the following in particular:

- Attendants should also be instructed in the use of the product by qualified personnel with the help of these instructions for use.
- The product has been adapted to the needs of the user. Further changes may be made only by qualified personnel. We recommend checking the product settings regularly in order to assure an optimum fit over the long term. For growing children and youths in particular, fitting should be performed every six months.
- In case of questions or problems, please consult the qualified personnel that adapted the product or the manufacturer's service (see inside back cover or back page for addresses).
- The product may be combined only with the options listed here. The manufacturer assumes no liability for combinations with third-party medical devices and/or accessories not included in the modular system. Please also observe the information in the section "Liability".
- Service and repairs to the product may only be carried out by qualified personnel. If you have any problems, please contact your specialist dealer. This ensures that any necessary repairs will be made exclusively with Ottobock spare parts.
- Your product may differ from the models shown. In particular, not all the options described in these instructions for use will be installed on your product.
- The manufacturer reserves the right to make technical changes to the model described in these instructions for use.

2 Product description

2.1 Function

The wheelchair is designed solely for individual use by persons who are unable to walk or who have a walking impediment, and can be operated either by the patient or by another person.

The wheelchair can be used on solid ground both indoors and outdoors.

2.2 Product Overview

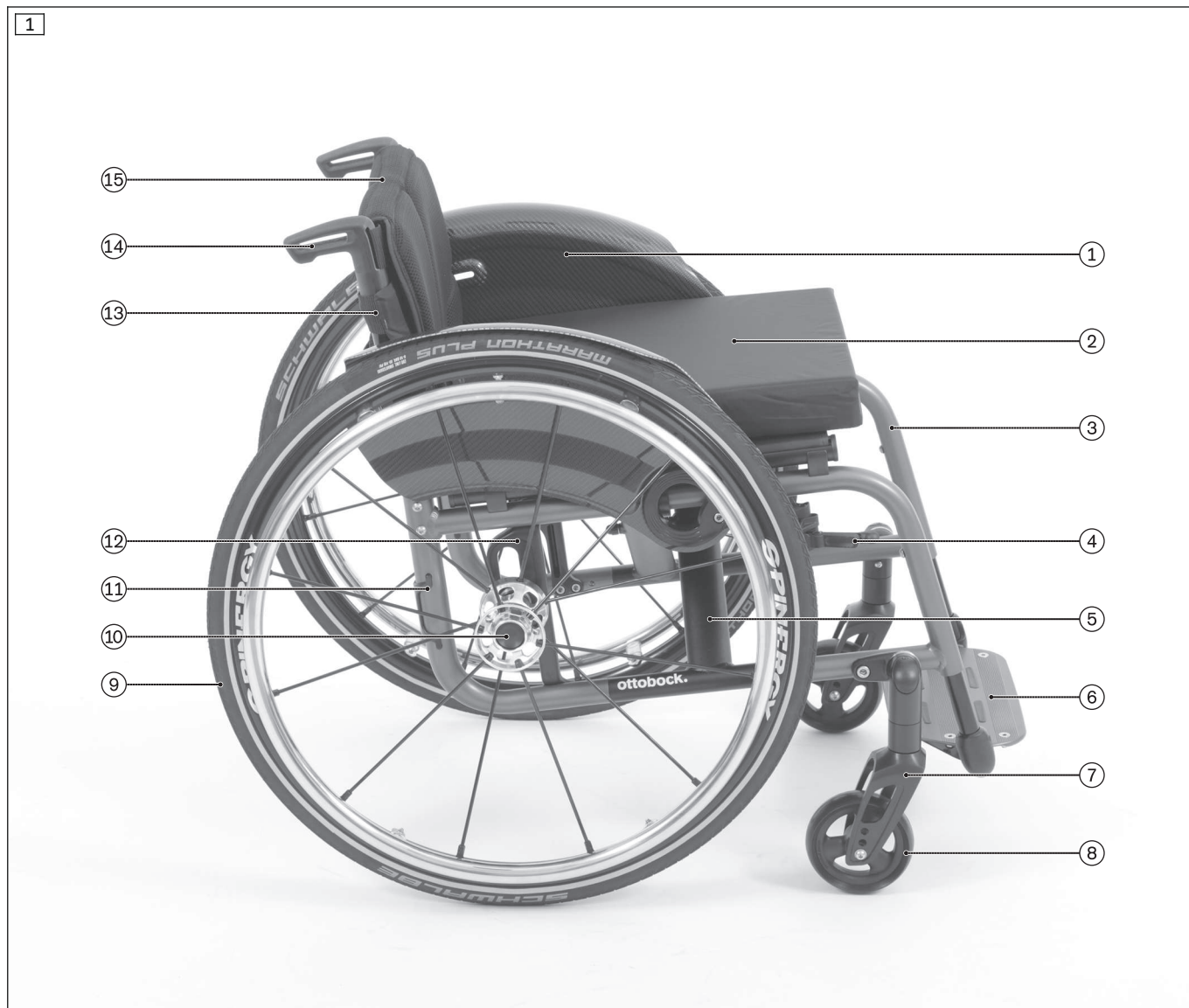

Avantage DS

Maximum load (in combination with double crossbrace): 140 kg

Thanks to its closed frame geometry, the Avantage DS allows very rigid and sporting use.

1	Side panel with clothing protector	9	Rear wheel with push ring
2	Seat/seat pad	10	Quick-release axle release button
3	Front frame	11	Rear frame
4	Outfront scissor wheel lock	12	Rear wheel adapter
5	Crossbrace	13	Back tube
6	Single-panel footplate	14	Push handle
7	Caster fork	15	Back/back upholstery
8	Caster wheel		

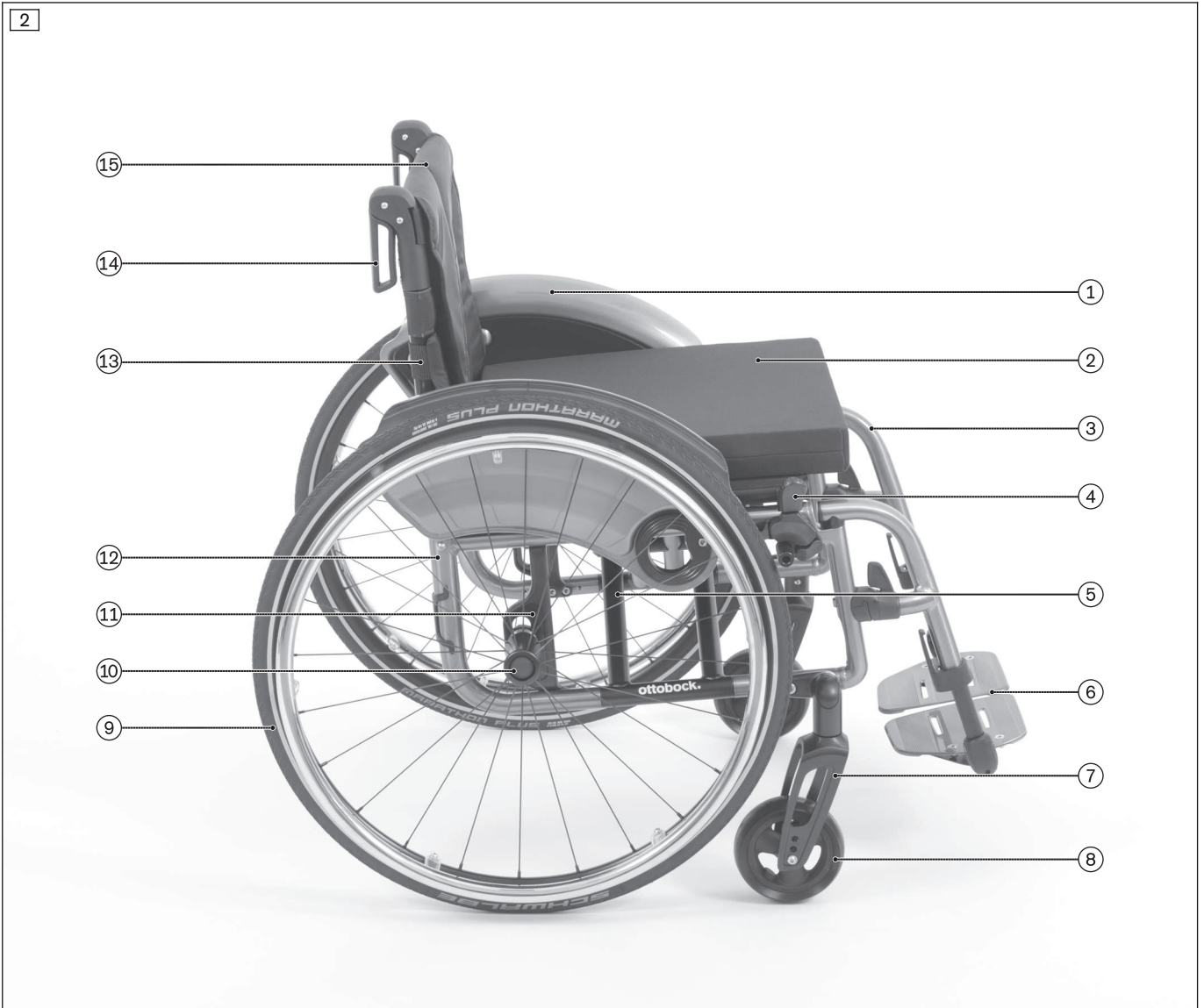

Avantgarde DV

Maximum load (in combination with double crossbrace): 140 kg

Thanks to its frame geometry, the Avantgarde DV offers precise leg guidance with the possibility of swinging away and removing the legrests. When the legrests are removed, the upright frame front section allows the wheelchair to be manoeuvred close to objects.

1	Side panel with clothing protector	9	Rear wheel with push ring
2	Seat/seat pad	10	Quick-release axle release button
3	Front frame with removable, swing-away legrest	11	Rear wheel adapter
4	Knee lever wheel lock	12	Rear frame
5	Crossbrace	13	Back tube
6	Segmented footplate	14	Push handle
7	Caster fork	15	Back/back upholstery
8	Caster wheel		

3 Safety

3.1 Explanation of warning symbols

 WARNING	Warning regarding possible serious risks of accident or injury.
--	---



Warning regarding possible risks of accident or injury.



Warning regarding possible technical damage.

3.2 Safety Instructions for Use

Hazards during preparation for use



Independent modification of settings

Serious injuries to the user due to unallowable changes to the product

- ▶ Do not modify the settings established by the qualified personnel.
- ▶ In case of problems with the settings (unsatisfactory seating position, caster wheel wobble, etc.) please contact the qualified personnel who adjusted your product.



Settings outside the safety limits

Tipping over, falling due to adjustment errors because of failure to observe the physical/psychological requirements of the user

- ▶ In certain versions and with certain settings, the wheelchair tends to tip backwards due to its design. This is an intentional feature designed to enable users with the corresponding physical prerequisites to manoeuvre quickly and nimbly.
- ▶ Users with the necessary physical and psychological preconditions can be supplied with such versions/settings. If the physical/psychological preconditions change, the wheelchair may no longer be used with these settings. Inform the responsible qualified personnel immediately in this case.



Improper handling of packaging materials

Risk of suffocation due to neglect of the duty to supervise

- ▶ Packaging materials must be kept out of the reach of children.

Risk of hand injuries



Pinching on components

Pinching, crushing due to lack of caution in danger areas

- ▶ Do not reach between the rear wheel and wheel lock or rear wheel and side panel when driving the wheelchair.
- ▶ Do not reach into the spokes of the rotating rear wheel.
- ▶ Pay attention not to pinch parts of your body at the wheel lock lever or between the side or frame parts.



Heat development when braking with push rings

Burns due to insufficient hand protection

- ▶ Wear wheelchair gloves when travelling at high speeds.

Hazards while driving



Improper use of the wheel lock

Falling due to abrupt braking, rolling away of the wheelchair, damage to the wheel lock

- ▶ Do not use the wheel lock as a driving brake.
- ▶ Apply the wheel lock to prevent the wheelchair from moving on uneven ground or during transfers (e.g. into a car).

⚠ CAUTION**Lack of driving experience**

Tipping over, falling due to errors in handling the product

- ▶ Practice on level, open ground first.
- ▶ Learn with the support of an assistant how the wheelchair reacts to changes in the centre of gravity.

⚠ CAUTION**Leaning forward in the wheelchair**

Tipping over, overturning due to incorrect centre of gravity

- ▶ Do not lean too far out of the wheelchair when trying to pick up objects.
- ▶ Lean well forward with your upper body when climbing gradients, overcoming obstacles on gradients or on ramps. If users cannot lean their upper body forward, accompanying persons must support the wheelchair from behind.

⚠ CAUTION**Risky operation**

Falling, tipping over backwards due to approaching obstacles incorrectly

- ▶ Push slowly when crossing obstacles (e.g. steps, curbs) and negotiating uphill or downhill slopes and inclines.
- ▶ Never cross obstacles at an angle. Always approach obstacles head on (at an angle of 90°).
- ▶ Raise the front wheels before crossing obstacles.
- ▶ Avoid collisions with obstacles and dropping off curbs/ledges.
- ▶ Avoid riding cross-country.

⚠ CAUTION**Lack of tipping resistance on public transport**

Tipping over, falling of the user, damage to the product due to incorrect positioning of the wheelchair

- ▶ Always observe currently applicable legal requirements when using public transport.
- ▶ Always ensure that you are held in place securely when travelling on public transport. To do so, use the wheelchair areas, wheelchair bays and restraint systems provided. Firmly tighten the wheel locks.
- ▶ Please note that the anti-tipper, if activated, may be exposed to heavy loads when the public transport vehicle starts to move. In order to avoid damage, the manufacturer recommends that the wheelchair is positioned at a right angle to the direction of travel if no restraint system for passengers with reduced mobility is available.

⚠ CAUTION**Incorrect handling at level crossings**

User may fall or tip over due to driving error

- ▶ Never go over a level crossing diagonally, but always at a right angle to the tracks. If you travel diagonally, the wheelchair casters may get caught in the tracks.
- ▶ Only cross railway systems and railway tracks in the designated areas.
- ▶ Stop before the level crossing and check to the left and right to make sure it is safe to cross.

⚠ CAUTION**Driving in the dark**

Risk of collisions with other traffic participants due to lack of lighting

- ▶ Wear bright clothing or clothing with reflectors.
- ▶ Install active lighting on your product.
- ▶ Ensure that the reflectors on the product are clearly visible.

Hazards when overcoming obstacles

⚠ WARNING

Overcoming steps and obstacles without assistance

Tipping over, falling of the user due to failure to observe transportation instructions

- ▶ Always have accompanying persons help you negotiate steps and other obstacles.
- ▶ Use available facilities (e.g. access ramps or lifts).
- ▶ If such facilities are not available, have 2 assistants carry you over the obstacle.

⚠ WARNING

Improper lifting by attendants

Tipping over, falling of the user due to lifting by removable components

- ▶ Only lift the product by firmly mounted components (e.g. main frame, push handles).
- ▶ Be sure that the clamping levers of the height-adjustable push handles are firmly tightened.

⚠ WARNING

Reduced ground clearance with the "foot-propelled chair" option

Tipping over, falling due to getting caught on obstacles

- ▶ Please note that wheelchairs with the "foot-propelled wheelchair" option might fall below the minimum ground clearance of **40 mm** depending on the selected settings for the lower leg length and the front seat height.
- ▶ Adjust your driving to the reduced ground clearance and exercise particular caution with obstacles on the ground e.g. steps, curbs and thresholds.

Hazard in case of broken skin

⚠ CAUTION

Prolonged contact with broken skin

Reddening of the skin or pressure points due to contamination with germs or incorrectly adapted seat cushion

- ▶ Check before using the product that the skin is not broken in areas subject to prolonged pressure (e.g., buttocks, back and rear side of the thighs).
- ▶ In case of problems, please contact the qualified personnel who adjusted the product.
- ▶ No liability is assumed for injuries caused by the use of the product with broken skin.

Hazards due to fire, heat and cold

⚠ CAUTION

Extreme temperatures

Hypothermia or burns through contact with components, failure of components

- ▶ Do not expose the product to any extreme temperatures (e.g. direct sunlight, sauna, extreme cold).

Hazards due to improper use of the product

⚠ WARNING

Overloading

Severe injuries if the wheelchair tips over due to overloading, damage to the product

- ▶ Do not exceed the maximum load capacity (see the nameplate and section "Technical data").
- ▶ Please note that certain options and add-on components will reduce the remaining load capacity.

⚠ WARNING**Exceeding the service life**

Serious injuries due to failure to observe the manufacturer's requirements

- ▶ Using the product beyond the specified expected service life (see Page 33) leads to increased residual risk and should only take place subject to the due diligence and deliberations of qualified personnel.
- ▶ If the service life is reached, the user or a responsible attendant should contact the qualified personnel who fitted the product or the manufacturer's servicing department (see inside rear cover or back page for address). Here the user can obtain information about known risks and the current options for refurbishing the product.

⚠ WARNING**Incorrect pushing or pulling of the wheelchair**

Falling, tipping over due to user error

- ▶ Only the push handles may be used for pushing or overcoming obstacles.
- ▶ The attendant should make sure that he/she has a secure stance and firm grip (on both sides).
- ▶ In case of damage, have the push handles repaired promptly.

⚠ CAUTION**Uncontrolled driving behaviour, unexpected sounds or odours**

Falling, tipping, collision with persons or nearby objects due to defects

- ▶ If any faults, defects or other hazards that can lead to personal injury are detected, the product must be taken out of service immediately. This includes uncontrolled movements as well as sounds that are unexpected or previously not noted or odours that deviate significantly from the state of the product at the time of delivery.
- ▶ Please contact your authorised dealer.

NOTICE**Use under incorrect environmental conditions**

Damage to product due to corrosion or abrasion

- ▶ Do not use the product in salt water.
- ▶ Also avoid – if possible – sand or other dirt particles that may damage the wheel bearings.

3.3 Further information

INFORMATION

Even in the event of compliance with all applicable guidelines and standards, alarm systems (e.g. in department stores) may respond to your product. Should this happen, remove your product from the area where the alarm was triggered.

3.4 Nameplate and warning labels

3.4.1 Nameplate

Label	Meaning	
	A Product; product reference number	
	B CE marking – product safety in accordance with EU directives	
	C Maximum load capacity (see section "Technical data")	
	D Manufacturer information, address, country of origin	
	E Serial number*	
	F Manufacturing date**	
	G Read the instructions for use before using the product.	
	H With CLT option only: The product has not been approved by the manufacturer for use as a seat in vehicles for transporting persons with reduced mobility	
	I European Article Number / Global Trade Item Number	
	K Product version***	
	The nameplate is located on the crossbrace.	

* YYYY = year of manufacture; WW = week of manufacture; PP = production site; XX...X = sequential production number

** YYYY = year of manufacture; MM = month of manufacture; DD = day of manufacture

*** NN = country code; VV = country-specific version; C = configuration

3.4.2 Warning labels

Label	Meaning
<p>Achtung! Die Antriebsräder sind Ihren Angaben entsprechend vorpositioniert. Die voreingestellte Position muß vor Inbetriebnahme vom Rollstuhlfahrer mit sichernder Unterstützung durch Fachpersonal auf Kippsicherheit und Funktion überprüft werden.</p> <p>Attention! The rearwheels are positioned according to your specifications. Before putting the wheelchair into operation the pre-adjusted position must be checked for tilting safety and proper functioning by the user supported safely by specialist staff.</p>	<p>(Safety loop on the wheelchair) Caution! The rear wheels have been pre-positioned according to your indications. Before using the wheelchair, this pre-adjusted position must be checked by the wheelchair user for function and stability against tipping with the assistance of qualified personnel.</p>

4 Delivery

4.1 Scope of delivery

The wheelchair is delivered preassembled and with the rear wheels removed packed in a crate.

The scope of delivery includes:

- Preassembled wheelchair
- 2 rear wheels
- Options according to the order
- Instructions for use (user)

4.2 Options

The standard model can be fitted to the user's personal requirements thanks to a large range of options. For use of these options: see Page 14 ff.

4.3 Storage

4.3.1 Storage during daily use

The wheelchair must be stored in a dry place.

4.3.2 Storage during extended disuse

The wheelchair must be stored in a dry place. During longer storage periods, an ambient temperature between **-10 °C and +40 °C** must be maintained.

It is not necessary to disassemble or fold up the wheelchair.

During extended storage, the knee lever wheel lock on wheelchairs with PU tyres (= tubeless tyres) must be released since tyre deformation may otherwise result.

Tyres contain chemical substances that can react with other chemical substances (such as cleaning agents, acids, etc.).

5 Preparation for use

5.1 Assembly

⚠ CAUTION

Exposed pinch points

Crushing, pinching due to incorrect handling

- ▶ When folding the wheelchair out or together, only grip by the specified components.

⚠ CAUTION

Failure to verify readiness for use before putting into operation

Tipping, falling due to incorrect adjustment or installation

- ▶ Before you start using the wheelchair for the first time, check the chosen wheelchair settings with the support of qualified personnel.
- ▶ After every assembly, check for proper mounting of the rear wheels. The quick-release axles must be securely locked in the receiver bushings.
- ▶ Pay particular attention to the stability against tipping, free running of the rear wheels and correct function of the wheel locks.
- ▶ Check the tyre pressure. The correct tyre pressure is printed on the sidewall. Ensure that the pressure is the same in both tyres.

INFORMATION

On the topic of disassembly/transport: see Page 25.

It only takes a few simple steps to prepare the wheelchair for use:

- 1) Attach the rear wheels to the quick-release axle mounting (see fig. 3). The quick-release axles must not be removable after releasing the push-button.

INFORMATION: For the "lock-release assist" option, see the section "Rear wheels".

- 2) Loosen the safety strap (see fig. 4).
- 3) Unfold the wheelchair (see fig. 5).

INFORMATION: While you are next to the wheelchair, tip it slightly toward you and press on the edge of the seat upholstery closest to you.

- 4) **If necessary:** Attach the legrests (see Page 16).
Fold down the footplates. When using a single-panel footplate, be sure the support of the footplate is locked into the receiver (see fig. 6).
- 5) Fit the seat cushion (see fig. 7). The seat cushion is secured against sliding by being pressed on to the hook-and-loop fastener.





6 Use

6.1 Techniques for using a wheelchair

Information and practical tips on fundamental techniques for using the wheelchair can be found in the brochure "Techniques for using a wheelchair" supplied with the product.

Should the brochure not be included with the product, it can be ordered under reference number 646D60. Further information on obtaining the brochure can be provided by the qualified personnel supplying the wheelchair or by Ottobock Service (addresses: see back inside cover or back cover).

6.2 Further instructions for use

Attaching loads (e.g. backpacks) can adversely affect stability. Therefore, when surmounting obstacles or driving on ramps or inclines, always remove the additional load or activate the anti-tipper.

The load must not exceed 5 kg.

We recommend that you always attach a wheelchair backpack to the push handles with the attachment straps provided.

- The recommended overall width for manual wheelchairs in an operational state is **700 mm**. This specification should ensure unhindered use of escape routes, for example. Please note that the wheelchair dimensions can exceed the recommended value in versions with very large seat widths (for more information see see Page 33 ff.).
- The wheelchairs in this series fully satisfy the minimum technical requirements for wheelchairs transportable by train. However, please note that it is possible that not every individual wheelchair will fulfil the minimum requirements due to the variation in designs (please see see Page 34 for further details).

6.3 Getting in and transferring

⚠ CAUTION

Incorrect handling when getting in

Risk of falling, tipping or rolling away due to incorrect handling

- ▶ Activate the wheel lock each time before you get into or out of or transfer to or from the wheelchair.
- ▶ Always get into the wheelchair from the side, where possible.
- ▶ Never step on the footrests/footplates when getting in and out.
- ▶ Do not support yourself on the wheel lock when getting in/out.

⚠ CAUTION

Incorrect caster wheel position when leaning forward in the wheelchair

Tipping over, falling due to incorrect caster wheel positioning

- ▶ Prior to activities that require you to bend forward in the wheelchair (e.g. tying your shoes), maximise the stability of the wheelchair.
- ▶ In order to do so, push the wheelchair backwards until the caster wheels turn forward.

Getting into the wheelchair in combination with transfer from one wheelchair to another is described below.

The wheelchair is designed for persons who normally move around independently in a wheelchair. Hence independently getting in/transferring is described here. If an assistant is required, the steps described here should be performed analogously with support:

- 1) Manoeuvre the wheelchairs such that they are positioned at an angle of approx. 45° to each other (see fig. 8). Ensure that the wheel locks do not become entangled.
- 2) Engage the wheel locks of the wheelchair currently in use.
- 3) On the other wheelchair, engage the wheel locks and fold up the footrest (footplate) (see fig. 9).
- 4) Move your feet from the footplate onto the floor and move forward in the wheelchair (see fig. 10).
- 5) Make the transfer to the second wheelchair (see fig. 11). The method illustrated is one possible way to support yourself yourself.

INFORMATION Find the most suitable method for yourself by practicing with the help of an assistant.

- 6) Finally fold the footplate down, place your feet on the footrest and release the wheel locks.

→ The wheelchair can now be used.





6.4 Legrests

⚠ CAUTION

Improper use of the legrests

Tipping over, falling due to errors in handling the product

- ▶ Fold up the footplates before getting in.

⚠ WARNING

Reduced ground clearance with the "foot-propelled chair" option

Tipping over, falling due to getting caught on obstacles

- ▶ Please note that wheelchairs with the "foot-propelled wheelchair" option might fall below the minimum ground clearance of **40 mm** depending on the selected settings for the lower leg length and the front seat height.
- ▶ Adjust your driving to the reduced ground clearance and exercise particular caution with obstacles on the ground e.g. steps, curbs and thresholds.

The legrests support the user's legs.

The height of the legrest has been adjusted by qualified personnel to the length of the user's lower legs.

The angle of the footrest has been set by the qualified personnel so that it allows the ankles to rest in a comfortable position.

6.4.1 Attaching/removing the legrests

The legrests of the Avantgarde DV can be removed to make it easier to get in and out as well as for transport.

Attaching the legrests

- 1) Hold the legrest **90°** out to the side and insert it into the legrest retainer (see fig. 12).
- 2) Swing the legrest into the direction of travel until it engages (see fig. 13).
- 3) Fold the footplate down (see fig. 14).

Removing the legrests

- 1) Fold the footplate up (see fig. 14).
- 2) Pull the release lever for the legrest to the side (see fig. 15).
- 3) Swing the legrest out by **90°** and remove it from the legrest retainer (see fig. 13).



6.4.2 Folding the footplate up and down

Segmented footplate

- Hold the footplate by the edge and fold it up or down (see fig. 14).

Folding up and swinging away the single-panel footplate

- 1) Unhook the footplate on one side and fold it up to the side (see fig. 16).
- 2) If necessary, the folded up footplate can also be swung away to the side (see fig. 17).



Folding down the single-panel footplate

- Fold down the footplate and make sure that the support of the footplate is locked into the receiver (see fig. 16).

6.5 Seat cushion and back upholstery

⚠ WARNING

Seat cushion and back padding may ignite

Burns due to user error

- ▶ The seat and backrest upholstery as well as padding fulfil the requirements for flame resistance according to the norms ISO 8191-2 or DIN EN 1021-2. However, they may still ignite if fire is handled improperly or negligently.
- ▶ Keep away from all ignition sources, especially lit cigarettes.

⚠ CAUTION

Wear of the seat and back upholstery

Loss of functionality due to prohibited continued use

- ▶ Have the seat and back upholstery replaced immediately in case of damage.

The product is equipped with seat and back upholstery. Hook-and-loop fasteners on the seat upholstery are used to attach the seat cushion. The seat cushion ensures pressure relief during use of the wheelchair. It was chosen by qualified personnel according to the needs of the user.

6.6 Side panels

⚠ CAUTION

Pinching at the side panels

Pinching, crushing due to lack of caution in danger areas

- ▶ Pay attention not to pinch parts of your body between the side panel or frame parts.

The side panels protect the user and his/her clothing from getting dirty.

If armrests have been installed on the wheelchair, they offer the user additional support for the forearms.

6.6.1 Adjusting the armrest height

The armrest height can be changed without the use of tools.

- 1) Pull the release lever in the round opening of the side panel upwards.
- 2) Push the armrest to the desired position.
- 3) Let go of the release lever. The armrest locks into place automatically.

6.6.2 Removing the side panels

To make getting into the wheelchair easier and for transportation, the side panels can be removed.

⚠ CAUTION

Incorrect use of the side panel

Health hazard, risk of breakage of the side panel mounting due to incorrect use

- ▶ Fold the side panel down such that it engages audibly in the side panel mounting.

INFORMATION

When using desk side panels in combination with an angle-adjustable back, the back angle can only be adjusted from **-3° to +15°**.

Folding back/removing

To make getting into the wheelchair easier the side panels can be folded up and removed:

- 1) Press the release lever of the desk side panel (see fig. 18).
- 2) Fold up the desk side panel by approx. **90°**.
- 3) Turn the desk side panel towards the backrest and pull it out of the side panel mounting (see fig. 19).



Attaching/closing

- 1) Turn the desk side panel towards the backrest and insert it into the side panel mounting (see fig. 19).
- 2) Rotate the desk side panel parallel to the wheelchair seat and fold it down.
- 3) Ensure that the desk side panel engages audibly in the mounting on the frame tube.

6.7 Push handles

The push handles make pushing the wheelchair easier for the attendant.

Some of the push handle designs allow the height to be adjusted to suit the needs of the attendant.

6.7.1 Adjusting the push handles

When using the "height-adjustable push handle" and "telescoping push handle" options, the height of the push handles can be adjusted to make pushing easier for the attendant.

- 1) Release the clamping lever.
 - 2) Adjust the height of the push handle.
 - 3) Close the clamping lever tightly.
- Both push handles must be adjusted to the same height.

6.8 Rear wheels

⚠ WARNING

Incorrect fitting of the rear wheels

Tipping, falling over of the user due to wheels coming off

- ▶ After each assembly, verify the proper fit of the rear wheels. The quick-release axles must be firmly locked in the wheel attachment.

⚠ WARNING

Defective tyres

Accidents/falling due to poor traction, reduced braking force or lack of manoeuvrability

- ▶ Maintain sufficient tyre pressure. Note the information in the section "Technical data" or on the tyre sidewall.
- ▶ Ensure that the pressure is the same in both tyres.
- ▶ Ensure that the tyres have sufficient tread depth.

⚠ CAUTION

Reaching into exposed drive parts

Crushing, pinching due to incorrect handling

- ▶ Do not reach between the rear wheel and wheel lock or rear wheel and side panel when driving the wheelchair.
- ▶ Do not reach into the spokes of the rotating rear wheel.

CAUTION**Heat development when braking with push rings**

Burns due to insufficient hand protection

- ▶ Wear wheelchair gloves when travelling at high speeds.

The wheelchair is moved, steered, braked and stopped with the help of the push rings on the rear wheels. To make transport easier, rear wheels with quick-release axle can be taken off the wheelchair.

6.8.1 Removing/mounting the rear wheels**Rear wheels with quick-release axle**

- 1) Release the wheel lock.
- 2) Grip the area between the spokes near the hub with your fingers.
- 3) Use your thumb to press the push-button on the quick-release axle.
- 4) Pull off/push on the rear wheel. The quick-release axles must not be able to be removed after the push-button has been released.

**Rear wheels with lock-release assist**

The lock-release assist allows the rear wheels to be installed even with heavily restricted movement of the arms and hands.

- 1) Open the lock-release assist according to the grip setting (see fig. 22= push down; see fig. 23 = pull up). The lock is open when the bar is horizontal (90° position).
- 2) Pull off / push on the rear wheel.
- 3) Close the lock-release assist (see fig. 22, see fig. 23 = pull up or push down).

INFORMATION: The wheels must fit on to the wheel attachments without there being any play after closure.

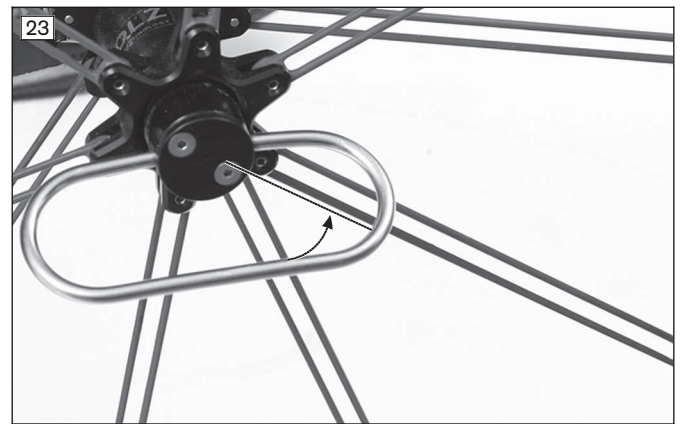

6.9 Caster wheels and caster forks

⚠ CAUTION

Incorrect caster wheel position when leaning forward in the wheelchair

Tipping over, falling due to incorrect caster wheel positioning

- ▶ Prior to activities that require you to bend forward in the wheelchair (e.g. tying your shoes), maximise the stability of the wheelchair.
- ▶ In order to do so, push the wheelchair backwards until the caster wheels turn forward.

The combination of caster wheels and caster forks ensures the ability to hold a straight line and navigate bends securely.

The caster wheels and caster forks have been chosen by the qualified personnel according to the needs of the users.

6.9.1 Approach in case of stiffness

In case of stiffness, the caster wheel axles should be cleaned and oiled.

Oiling the caster axle

- 1) Remove dirt (such as hairs) from the caster axle between the caster wheel and caster fork.
- 2) Lubricate the caster axle between the caster wheel and caster fork with a few drops of thin, resin-free oil (sewing machine oil).

6.10 Wheel locks

The wheel locks secure the parked wheelchair against rolling away.

The drum brakes allow the attendant to slow the wheelchair easily and safely by activating the wheel lock lever.

6.10.1 Using the wheel locks

⚠ WARNING

Improper use of the wheel lock

Falling due to abrupt braking, rolling away of the wheelchair, crushing of hands

- ▶ Do not use the wheel lock as a driving brake.
- ▶ Always engage the wheel lock on both sides.
- ▶ Apply the wheel lock to prevent the wheelchair from moving on uneven ground or during transfers (e.g. into a car).
- ▶ Do not reach between the rear wheel and the wheel lock when driving the wheelchair.
- ▶ Ensure that the knee lever wheel lock is properly adjusted (approx. **5 mm** gap to the tyres).
- ▶ Please contact the qualified personnel who adjusted your product for readjustment of the wheel lock.

Activating/deactivating the knee lever wheel lock

- 1) Push the handle of the knee lever wheel lock forward (see fig. 24).
→ The wheel lock bolt secures the wheel.
- 2) Pull the handle of the knee lever wheel lock up.
→ The wheel lock bolt releases the wheel.



Activating/deactivating the scissor wheel lock (Outfront scissor wheel lock)

- 1) Reach under the seat and pull the handle of the scissor wheel lock rearwards from the side (see fig. 25).
→ The wheel lock bolt secures the wheel.
- 2) Pull the handle of the scissor wheel lock forwards to unfold (see fig. 26).
→ The wheel lock lever releases the wheel.



6.10.2 Using the knee lever wheel lock for user and attendant

This wheel lock type can be used by both the user and an attendant.

- 1) Pull the wheel lock lever (see fig. 27, item 1).
- 2) If necessary, secure the wheel lock lever by additionally actuating the locking slide (see fig. 27, item 2).
→ The wheelchair remains securely braked.
- 3) Deactivate the wheel lock by pressing the locking slide.
→ The wheelchair can be pushed again.

The rear wheels can still be removed via the quick-release axles when the wheel lock lever is released.

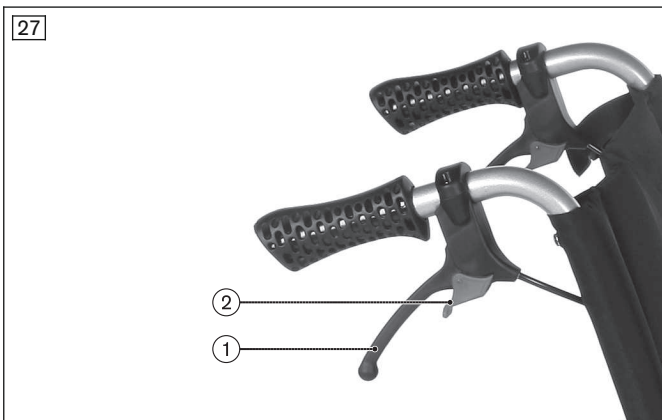

6.11 Anti-tipper/tip-assist

⚠ WARNING

Anti-tipper not activated

Tipping over, falling of the user due to improper operation of a safety device

- ▶ Ensure that an installed anti-tipper is activated before travelling over obstacles and on inclines.
- ▶ The anti-tipper has to engage audibly prior to use. Proper engagement must be checked by the user or an accompanying person.
- ▶ For transfemoral amputees, the use of an anti-tipper is highly recommended.

⚠ WARNING**Incorrectly adjusted anti-tipper**

Tipping over, falling of the user due to errors in handling the product

- ▶ If only 1 accompanying person helps in overcoming steps, the accompanying person must first adjust the anti-tipper so that it cannot collide with the steps during transport.
- ▶ The accompanying person must adjust the anti-tipper again correctly after overcoming the steps.

⚠ WARNING**Incorrectly adjusted anti-tipper**

Risk of falling as a result of incorrectly adjusted anti-tipper.

- ▶ The anti-tipper may only be adjusted by qualified personnel.

The anti-tipper prevents the wheelchair from tipping backwards when overcoming obstacles and going uphill. It is set for a maximum ground clearance of **50 mm** and so that the anti-tipper rollers, as a minimum, project fully beyond the largest diameter of the rear wheels.

The tip-assist makes overcoming obstacles easier for the attendant.

6.11.1 Activating and deactivating the anti-tipper

A mounted anti-tipper must always be active.

When overcoming obstacles (such as steps and curbs that are not lowered) **upwards**, the anti-tipper rollers contact the ground.

When overcoming obstacles (such as steps and curbs that are not lowered) **downwards**, the anti-tipper has to be deactivated by the user or attendant to avoid damaging the anti-tipper.

Activation

- 1) The anti-tipper is pressed down with the hand or foot (see fig. 28, item 1; see fig. 29, item 1).
- 2) Swing the anti-tipper back and allow it to engage (see fig. 28, item 2; see fig. 29, item 2).

Deactivation

- 1) From above, press on the anti-tipper with the hand or foot until it disengages (see fig. 30, item 1; see fig. 31, item 1).
- 2) Rotate the anti-tipper forward by **180°** and release it (see fig. 30, Pos. 1; see fig. 31, Pos. 1).

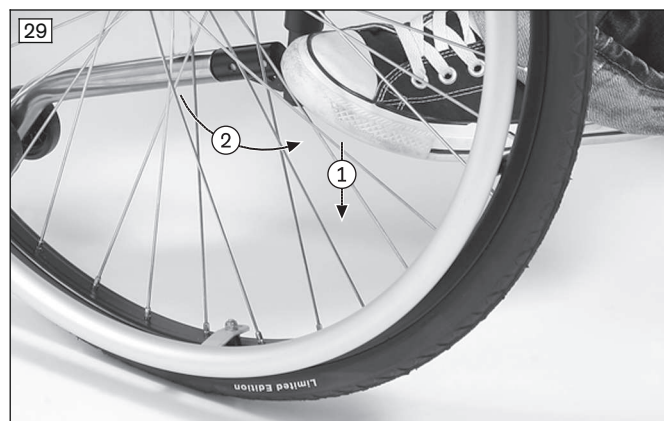
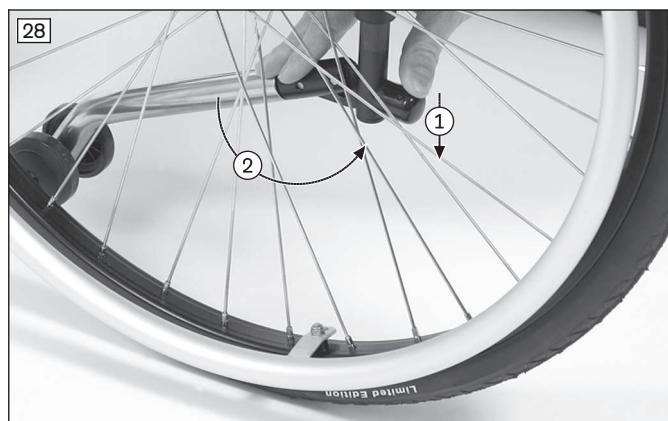

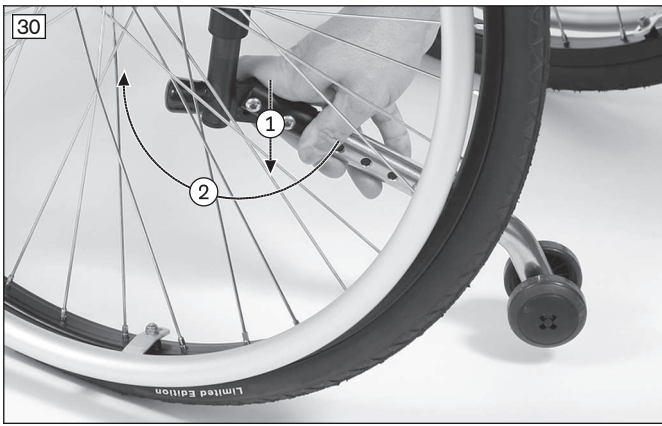

6.11.2 Using the tip-assist

- 1) At an obstacle, place one foot on the tip-assist and push down.
- 2) The wheelchair can then be easily tipped by pressing down on the push handles at the same time.

6.12 Transport wheels

⚠ CAUTION

Knee lever wheel lock when the rear wheels are removed

Risk of accident, falling due to loss of functionality of the knee lever wheel lock

- ▶ Note that a wheelchair with transport wheels can only be braked by an attendant.

⚠ CAUTION

Incorrect height setting

Risk of tipping or falling due to the sloped product setting

- ▶ Always adjust the height equally on both sides.

The transport wheels permit movement through very narrow passages (e.g. in trains or aircraft).

Transport wheels take the place of the rear wheels. In order to move, an attendant is required to push the wheelchair.

6.12.1 Using the transport wheels

- 1) Press in the locking pin and adjust the height equally on both sides. The locking pin must engage audibly.
 - 2) Pull off the rear wheels.
Whenever possible, this should be done when the user is not sitting in the wheelchair. If the user is sitting in the wheelchair, proceed as follows:
 - 3) The first attendant holds the wheelchair in a stable position so that the rear wheels are relieved in turn.
 - 4) The second attendant carefully removes the first and second rear wheel one after the other.
- The wheelchair can now be pushed on the transport wheels.



6.13 Lap belt

⚠ CAUTION

Incorrectly adjusted lap belt

Incorrect user posture, illness, falling of the user due to installation/adjustment errors

- ▶ Do not modify the settings established by the qualified personnel. In case of problems with the adjustments (unsatisfactory sitting position) please contact the qualified personnel who fitted the product.
- ▶ The lap belt has to fit closely but not too tightly so the user is not injured. It should be possible to slide two fingers comfortably between the belt and thigh.
- ▶ Have the settings of the belt system checked regularly. Adjustments may be required due to the growth of the user or because of changes in the course of the disease or different clothing.

The lap belt prevents the user from slipping and supports positioning.

It is installed on the product by qualified personnel if needed and adapted to the requirements of the user.

Information about subsequent acquisition and mounting is provided by the qualified personnel that handed over the product.

Using the lap belt

- 1) Open the belt using the metal snap / buckle.
- 2) Place the user in an upright, 90° seated position (if physiologically possible). Ensure that the back is up against the backrest padding (if physiologically possible).
- 3) Fasten the belt by means of the metal snap or buckle.
- 4) The lap belt should be at an angle of about **60°** to the seat surface. The belt strap should run across the thighs in front of the pelvic bones (see fig. 34).

Possible errors

- The lap belt is positioned above the pelvis of the user in the area of the soft part of the stomach.
- The user does not sit upright in the seat.
- If the lap belt is too loose, the user can shift/slide out to the front.
- During the installation/adjustment, the safety belt is led over parts of the seating system (e.g. over armrests or seat pads). This causes the lap belt to lose its retaining function.

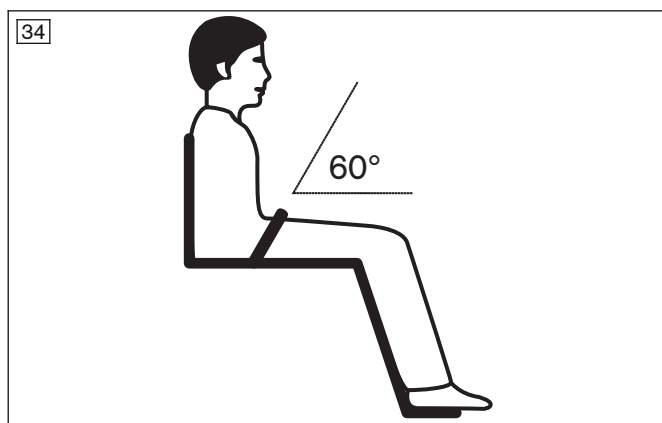

6.14 Additional options

The product may be equipped with additional options.

The options are firmly mounted to the product by qualified personnel or the manufacturer and are pre-adjusted by qualified personnel at delivery.

6.15 Disassembly and transport

NOTICE

Deformation when folded

Damage to the product, problems unfolding due to unallowable loads

- ▶ Never place heavy objects on the folded product.

The wheelchair must be prepared for transport in a passenger vehicle.

- 1) Single-panel footplate: Fold up and swing away to the side (see fig. 6, see fig. 17).
Segmented footplate: Fold up both sections (see fig. 14).
INFORMATION: For the Avantgarde DV the legrests can also be removed, thus further reducing the packing size (see Page 16).
 - 2) Remove the seat cushion.
 - 3) Pull up the seat upholstery until the wheelchair folds together (see fig. 35).
 - 4) Fasten the safety strap (see fig. 36).
 - 5) Insert four fingers between the spokes of the rear wheel and press the knob of the quick-release axle with your thumb. Pull off the rear wheel outwards (see fig. 3).
- INFORMATION: For the "lock-release assist" option, see the section "Rear wheels".**



6.16 Use in vehicles for transporting persons with reduced mobility

6.16.1 Avantgarde DV/DS without CLT option

⚠ WARNING

Use in vehicles for transporting persons with reduced mobility

Serious injuries in case of accidents due to user error

- ▶ Always use the seats and personal restraint systems in the vehicle for transporting persons with reduced mobility first. This is the only way to ensure optimum protection of passengers in the event of an accident.
- ▶ If the product is to be used as a seat in a vehicle for transporting persons with reduced mobility, the safety elements offered by the manufacturer and appropriate personal restraint systems must be used. For more information please refer to our brochure with the order number 646D158.

⚠ WARNING

Use of the belt system as a passenger restraint system in vehicles for transporting persons with reduced mobility is forbidden

Serious injuries due to improper handling of the product

- ▶ Under no circumstances may the belts and positioning aids offered with the product be used as part of a passenger restraint system in vehicles for transporting persons with reduced mobility.
- ▶ Note that the belts and positioning aids offered with the product are only intended to help support the user sitting in the product.

⚠ WARNING

Prohibited transportation of the passenger with activated back angle adjustment

Loss of safe restraint in the product due to user error

- ▶ Ensure the passenger is seated in a nearly upright position during transport.
- ▶ If a back angle adjustment mechanism is installed, move the backrest to a nearly upright position prior to travel.
- ▶ Check the locking mechanism on both sides.

The product may be used as a seat in vehicles for transporting persons with reduced mobility.

During transport in vehicles for transporting persons with reduced mobility, the product must be sufficiently secured with attachment straps.

The transport weight of the person to be transported in a vehicle for transporting persons with reduced mobility corresponds to the maximum permissible user weight (see the "Technical data" section).

6.16.1.1 Required accessories

To use the product as a seat in a vehicle for transporting persons with reduced mobility, additional accessories have to be mounted:

- Avantgarde DS/DV: 4 belt loops (crash-tested according to ISO 7176-19)

The qualified personnel who fitted the wheelchair can provide more information about accessories.

6.16.1.2 Installation

Required materials

- 4 belt loops (e.g. from Unwin Safety Systems, Q'Straint)
- 1) Attach one belt loop around the frame tube on the left and right of the front frame, respectively, wrapping around the frame tube once or twice depending on the length (Avantgarde DS: see fig. 37, item 1; Avantgarde DV: see fig. 38, item 1).
 - 2) Attach the hooks of the safety belt system to the belt loops (Avantgarde DS: see fig. 37, item 2; Avantgarde DV: see fig. 38, item 2).
 - 3) Insert 1 belt loop at the left and right, respectively, between the upper frame section and seat tube (see fig. 39, item 1).
 - 4) Attach the hooks of the safety belt system to the belt loops (see fig. 39, item 2).
 - 5) Before tightening the safety belt system, verify the correct position of the belt loops.
 - Avantgarde DS: The belt loops are installed (see fig. 37; see fig. 39).
 - Avantgarde DV: The belt loops are installed (see fig. 38; see fig. 39).

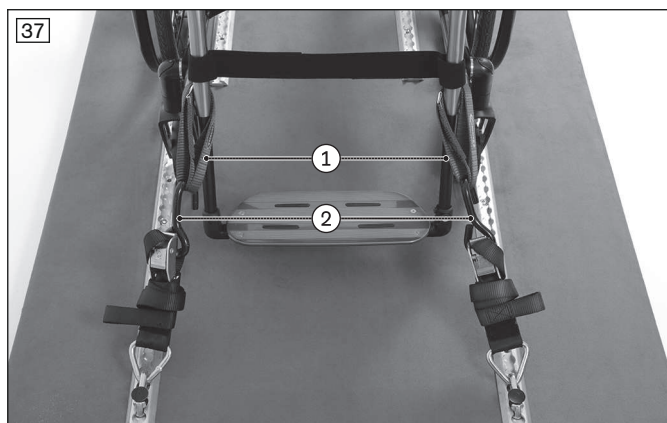

Using the product in the vehicle

The product has been tested according to ISO 7176-19.

6.16.1.3.1 Use with belt loops

Securing the product in the vehicle for transporting persons with reduced mobility

- 1) Position the product in the vehicle for transporting persons with reduced mobility. For more information please refer to section 5 of the brochure with order number 646D158.

- 2) Engage the attachment straps in the belt loops at the front and rear, and then tighten them.
 - Avantgarde DS: The product showing the correct positioning of the attachment straps (see fig. 40).
 - Avantgarde DV: The product showing the correct positioning of the attachment straps (see fig. 41).



Placement of the restraint lap belt

- 1) Pull each end of the restraint lap belt from the inner side of the seat through to the outside (see fig. 42).
- 2) Hook the end of the restraint lap belt onto the pin (see fig. 43).
 - The restraint lap belt is pulled through and fastened.



Restrictions for use

⚠ WARNING

Risk of accidents and injury due to using the product with certain settings and/or installed options

Severe injury in case of accidents due to options coming loose

- ▶ Before using the product as a seat in a vehicle for transporting persons with reduced mobility, remove options that need to be taken off for safe transportation. Please observe the following table.
- ▶ Stow all dismantled components securely in the vehicle for transporting persons with reduced mobility.
- ▶ Please note that certain settings on the product exclude the use of the product in a vehicle for transporting persons with reduced mobility.

Option ¹⁾	Transportation in a vehicle for transporting persons with reduced mobility not possible	Option must be removed	Secure option on product
Add-on drive	X		
Crutch holder with tip-assist right/left (Avantgarde DS) Crutch holder (Avantgarde DV)	X		
Wheelbase extension	X		

Option ¹⁾	Transportation in a vehicle for transporting persons with reduced mobility not possible	Option must be removed	Secure option on product
Angle-adjustable back	X		
Back height < 400 mm	X		
Shock absorber	X		
Transport wheel			X ²⁾
Tray		X	
Lap belt			X ³⁾

¹⁾ Not all of the options named are installed on all products.

²⁾ Transport wheels can remain on the wheelchair with installed rear wheels during transportation in a vehicle for transporting persons with reduced mobility.

³⁾ The lap belt can be used to position the passenger during transport. Using the personal restraint system is nevertheless required.

6.16.2 CLT option

WARNING

Improper use in vehicles for transporting persons with reduced mobility

Risk of serious injury when using the product as a seat

- ▶ The product has **not** been approved by the manufacturer for use as a seat in vehicles for transporting persons with reduced mobility. Please refer to the prohibition symbol on the nameplate (see below).
- ▶ In vehicles for transporting persons with reduced mobility, only use the seats installed in the vehicle with the corresponding personal restraint systems.
- ▶ Information on the current status of our measures is available from your specialist dealer.



If the adjacent symbol appears on the nameplate, this indicates the following:
The power wheelchair may **not** be used as a seat in vehicles for transporting persons with reduced mobility.

6.17 Care

6.17.1 Cleaning

- 1) Clean the padding and upholstery with warm water and a mild detergent.
- 2) Remove any spots with a sponge or a soft brush.
- 3) Rinse with clear water and let the components dry.

Important information on cleaning

- Do not use any aggressive cleaners, solvents or hard brushes etc.
- Clean plastic parts, frame parts and the chassis and wheels with a mild cleaner and a damp cloth. Dry thoroughly afterwards.

6.17.1.1 Cleaning Seat Cushions

Standard seat cushion

- ▶ Clean the seat cushion according to the attached care label.

Seat cushion with foam core

- 1) Open the zipper and remove the foam core (see fig. 44).
- 2) Clean the cover according to the attached care label.
- 3) Wash all foam parts by hand at **40°C** using a mild, environmentally friendly detergent. Allow to air dry.
- 4) Reinsert the foam core with proper alignment. Close the zipper.



6.17.1.2 Cleaning belts

Cleaning a belt system with metal buckle

INFORMATION

Observe the washing recommendations on the product and the information in the corresponding instructions for use provided for the product.

- Belts with metal snaps may **not be washed in washing machines** as the penetration of water could cause corrosion and subsequent malfunctions.
- Clean the belt straps by gently dabbing them with warm soapy water (with some disinfectant) or carefully wiped with a dry, clean, absorbent cloth.

Cleaning a belt system with plastic buckle

- Depending on the model, straps with plastic buckles can be washed in the washing machine between **40 °C** and **60 °C**.
- Recommendation: Use a laundry bag or net and mild detergent.

INFORMATION

Alternatively, the belt straps can be cleaned by gently dabbing them with warm soapy water (with some disinfectant) or carefully wiped with a dry, clean, absorbent cloth.

Additional cleaning instructions

- Allow the belts to air dry. Ensure that the belts and pads are completely dry before installation.
- Do not expose the belts to direct heat (e.g. sunshine, stove or radiator).
- Do not iron or bleach the belts.

6.17.2 Disinfection

- 1) Thoroughly clean the pads and handles before disinfecting.
- 2) Wipe all parts of the wheelchair with a disinfectant.

Important information about disinfecting

- If the product is used by more than one person, using a conventional disinfectant is required.
- Only use colourless water-based disinfectants. Observe the instructions for use provided by the manufacturer.

7 Maintenance and repair

7.1 Maintenance

- The function of the product should be checked before each use.
- The product should not be used if defects are noted. This applies in particular in case of instability of the product or altered driving characteristics as well as problems with the user's seating position or the stability of the seat. Inform the qualified personnel promptly for the rectification of defects.
- This also applies if loose, worn, bent or damaged components, cracks in the frame or broken frame components are identified.

- Some maintenance tasks can be carried out to a certain extent by the user at home (see the sections "Maintenance intervals" and "Maintenance tasks").
- The manufacturer also recommends regular maintenance **every 12 months** by authorised, qualified personnel.
- Failure to maintain the product can lead to serious or life-threatening injury to the user of the product.
- Service and repairs may only be carried out by authorised, qualified personnel or the manufacturer. This will ensure that only Ottobock spare parts are used for repairs.

7.1.1 Maintenance intervals

The functions described below must be checked by the user or an attendant at the specified intervals:

Inspection task	Before each use	Monthly	Quarterly
Functional test of the wheel locks	X		
Sagging of the seat or back upholstery		X	
Stability of the legrests		X	
Visual inspection of wear parts (e.g. tyres, bearings)		X	
Soiling of bearings		X	
Damage to the push ring		X	
Air pressure (information see tyre sidewall)		X	
Wear and tear of the folding device		X	
Check of the spoke tension on the rear wheels			X
Check of all bolted connections			X

7.1.2 Maintenance tasks

To ensure smooth operation at all times, users or attendants with some technical skills can maintain some parts of the product:

- Bolted connections must be periodically checked for tightness, especially during the initial period of use or after adjustments have been made to the wheelchair. If a screw connection loosens repeatedly, contact the specialist dealer promptly.
- Hair and dirt particles generally accumulate between the caster wheel and fork. This can restrict the caster wheels from rotating smoothly. For this purpose, lubricate the caster axle between the caster wheel and caster fork with a few drops of thin, resin-free oil (sewing machine oil).
CAUTION: Do not remove the caster wheel yourself. If the caster wheel continues to not rotate smoothly, please contact the qualified personnel.
- The rear wheels are equipped with a quick-release axle system as standard equipment. To keep this system operational, ensure that no dirt adheres to the quick-release axle or receiver bushing. Periodically lubricate the quick-release axle very lightly with thin, resin-free oil (sewing machine oil).
- If the wheelchair becomes wet, it should be rubbed dry again.

7.2 Repair

7.2.1 Inner tube, rim tape and tyre replacement

⚠ CAUTION

Improper tyre replacement

Injuries to the user due to incorrect installation, product damage

- ▶ No person is permitted to sit in the wheelchair during tyre replacement
- ▶ Before removing a wheel, support the product so it cannot tip over.
- ▶ Always replace the tyres in pairs. Two differently worn tyres affect the directional stability of the wheelchair.

INFORMATION

When driving outdoors, always carry a repair kit and tyre pump (when using pneumatic tyres) in case of emergency.

Suitable tyre pumps are listed on the order form and are supplied with the product. An alternative is tyre foam, which fills your tyre and then hardens (available from bicycle shops, etc.).

Repairing flat tyres requires only the necessary tools and users may change tyres themselves if they wish:

Removal and preparing for installation

- 1) Carefully remove the tyre from the rim using appropriate tools.
INFORMATION: Take care not to damage the rim or the inner tube.
- 2) Unscrew the valve nut from the valve and remove the tube.
- 3) Repair the tube according to the directions in the repair kit or replace it with a new tube.
- 4) Before fitting the tyre again, inspect the rim bed and tyre inner wall for foreign objects. This could have caused the puncture.
- 5) Before installing the tube, check that the rim band is in proper condition. The rim band protects the tube from being damaged by the ends of the spokes.



Replacing the rim band (only when necessary)

- 1) If the rim band needs to be replaced, remove it from the rim.
- 2) Install the new rim band on the inside of the rim, making sure the valve opening is in the right position.
- 3) Glue the rim band in place if this is intended. Ensure that all spoke ends are covered.

Installing the tube and tyre

- 1) Behind the valve, push one side of the tyre over the edge of the rim.
- 2) Slightly inflate the tube until it starts to assume its round shape.
- 3) Unscrew the valve nut from the tube and push the valve through the valve opening in the rim.
- 4) Insert the tube into the tyre.
- 5) Mount the other side of the tyre on the rim, starting from the position across the valve. Ensure that the tube is not pinched between the tyre and rim during this process.



Inflating the tube

- 1) Ensure that the valve is positioned perpendicularly for proper positioning of the tube and tyre in the region of the valve.
- 2) Firmly screw on the valve nut.
- 3) Inflate the tube so that the tyre can still be pressed in easily with your thumb.
INFORMATION: If the circumferential lines on the two sides of the tyre are both at an even distance from the rim, the tyre is centred. If not, let some air out and realign the tyre.

- 4) Inflate the tube to the maximum pressure specified by the tyre manufacturer (see information printed on the tyre sidewall).
- 5) Firmly screw the valve cap onto the valve.

8 Disposal

8.1 Disposal Information

Return the product to the specialist dealer for disposal.

All components of the product must be disposed of properly in accordance with the respective national environmental regulations.

9 Legal information

All legal conditions are subject to the respective national laws of the country of use and may vary accordingly.

9.1 Liability

The manufacturer will only assume liability if the product is used in accordance with the descriptions and instructions provided in this document. The manufacturer will not assume liability for damage caused by disregard of this document, particularly due to improper use or unauthorised modification of the product.

9.2 CE Conformity

This product meets the requirements of the European Directive 93/42/EEC for medical devices. This product has been classified as a class I device according to the classification criteria outlined in Annex IX of the directive. The declaration of conformity was therefore created by the manufacturer with sole responsibility according to Annex VII of the directive.

9.3 Warranty

Further information on the warranty terms and conditions can be obtained from the qualified personnel that has fitted this product or the manufacturer's service (see inside back cover for addresses).

9.4 Service Life

Expected service life: **4 years**.

The design, manufacturing and requirements for the intended use of the product are based on the expected service life. These also include the requirements for maintenance, ensuring effectiveness and the safety of the product.

Using the product beyond the specified expected service life leads to increased residual risk and should only take place subject to the due diligence and deliberations of qualified personnel.

If the service life is reached, the user or a responsible attendant should contact the qualified personnel who fitted the product or the manufacturer's servicing department (see inside rear cover or back page for address). Here the user can obtain information about known risks and the current options for refurbishing the product.

9.5 Trademarks

All product names mentioned in this document are subject without restriction to the respective applicable trademark laws and are the property of the respective owners.

All brands, trade names or company names may be registered trademarks and are the property of the respective owners.

Should trademarks used in this document fail to be explicitly identified as such, this does not justify the conclusion that the denotation in question is free of third-party rights.

10 Technical data

INFORMATION

- ▶ Much of the technical data below is given in mm. Please note that product settings – unless otherwise specified – cannot be adjusted in the mm range but only in increments of approx. **0.5 cm** or **1 cm**.
- ▶ Note that the values achieved during adjustment may deviate from the values specified below. The deviation can be **±10 mm** and **±2°**.

Avantgarde DS/DV – general information

	DS	DV
Maximum load capacity [kg]	140 ¹⁾	140 ¹⁾
Weight [kg]	From 8.7 ²⁾	From 9.7 ²⁾
Transport weights [kg]	Frame: from 6.1 ²⁾ 24" rear wheel: from 1.3 (incl. quick-release axle) ²⁾	Frame: from 5.6 ²⁾ Legrest: from 0.75 ²⁾ 24" rear wheel: from 1.3 (incl. quick-release axle) ²⁾
Seat width [mm]	320–500	320–500
Anterior seat height [mm]	380–540	380–540
Rear seat height [mm]	360–510	360–510
Seat depth [mm]	360–520	360–520
Overall length [mm]	720–1040 ⁴⁾	720–1040 ⁴⁾
Overall width [mm]	490–725	490–725
Overall height	580–1100	580–1100
Folding size from	260	260
Back height	250–500	250–500
Lower leg length	160–510	160–510
Front frame angle	70°/80°	75°
Min. tyre pressure [bar]	7 ³⁾	7 ³⁾

¹⁾ With CLT option: 100 kg

²⁾ The specified weights vary according to the selected options and model.

³⁾ Varies according to tyre option; see the print on the tyre wall

⁴⁾ + 95 mm with wheelbase extension

11 Appendices

11.1 Threshold values for wheelchairs transportable by train

INFORMATION

- ▶ The products in this series fully satisfy the minimum technical requirements of regulation (EU) No. 1300/2014 regarding train accessibility for people with disabilities. However, not all versions can comply with all threshold values due to different settings.
- ▶ With the help of the table that follows, you or the qualified personnel can take measurements and verify whether the specific product in question meets the threshold values.

Feature	Threshold value (according to Directive (EU) No. 1300/2014)
Length [mm]	1200 (plus 50 mm for the feet)
Width [mm]	700 (plus 50 mm on each side for the hands when moving)
Smallest wheels ["]	approx. 3 or greater (according to the directive, the smallest wheel must be able to overcome a gap measuring 75 mm horizontally and 50 mm vertically)
Height [mm]	max. 1375; including a 1.84 m large male wheelchair user (95th percentile)
Turning radius [mm]	1500
Maximum weight [kg]	200 (for wheelchair and user, including any baggage)
Maximum obstacle height that can be overcome [mm]	50
Ground clearance [mm]	60 (at an upward slope angle of 10°, ground clearance must measure at least 60 mm under the footrest for going forward at the end of the slope)
Maximum inclination angle on which the wheelchair will remain stable [°]	6 (dynamic stability in all directions)

Feature	Threshold value (according to Directive (EU) No. 1300/2014)
	9 (static stability in all directions, also when wheel lock engaged)

Kundenservice/Customer Service

Europe

Otto Bock HealthCare Deutschland GmbH
Max-Näder-Str. 15 · 37115 Duderstadt · Germany
T +49 5527 848-3433 · F +49 5527 848-1460
healthcare@ottobock.de · www.ottobock.de

Otto Bock Healthcare Products GmbH
Brehmstraße 16 · 1110 Wien · Austria
F +43 1 5267985
service-admin.vienna@ottobock.com · www.ottobock.at

Otto Bock Adria d.o.o. Sarajevo
Ramiza Salčina 85
71000 Sarajevo · Bosnia-Herzegovina
T +387 33 255-405 · F +387 33 255-401
obadria@bih.net.ba · www.ottobockadria.com.ba

Otto Bock Bulgaria Ltd.
41 Tzar Boris III Blvd. · 1612 Sofia · Bulgaria
T +359 2 80 57 980 · F +359 2 80 57 982
info@ottobock.bg · www.ottobock.bg

Otto Bock Suisse AG
Luzerner Kantonsspital 10 · 6000 Luzern 16 · Suisse
T +41 41 455 61 71 · F +41 41 455 61 70
suisse@ottobock.com · www.ottobock.ch

Otto Bock ČR s.r.o.
Protetická 460 · 33008 Zruč-Senec · Czech Republic
T +420 377825044 · F +420 377825036
email@ottobock.cz · www.ottobock.cz

Otto Bock Iberica S.A.
C/Majada, 1 · 28760 Tres Cantos (Madrid) · Spain
T +34 91 8063000 · F +34 91 8060415
info@ottobock.es · www.ottobock.es

Otto Bock France SNC
4 rue de la Réunion · CS 90011
91978 Courtaboeuf Cedex · France
T +33 1 69188830 · F +33 1 69071802
information@ottobock.fr · www.ottobock.fr

Otto Bock Healthcare plc
32, Parsonage Road · Englefield Green
Egham, Surrey TW20 0LD · United Kingdom
T +44 1784 744900 · F +44 1784 744901
bockuk@ottobock.com · www.ottobock.co.uk

Otto Bock Hungária Kft.
Tatai út 74. · 1135 Budapest · Hungary
T +36 1 4511020 · F +36 1 4511021
info@ottobock.hu · www.ottobock.hu

Otto Bock Adria d.o.o.
Dr. Franje Tuđmana 14 · 10431 Sveta Nedelja · Croatia
T +385 1 3361 544 · F +385 1 3365 986
ottobockadria@ottobock.hr · www.ottobock.hr

Otto Bock Italia Srl Us
Via Filippo Turati 5/7 · 40054 Budrio (BO) · Italy
T +39 051 692-4711 · F +39 051 692-4720
info.italia@ottobock.com · www.ottobock.it

Otto Bock Benelux B.V.
Mandenmaker 14 · 5253 RC
Nieuwkuijk · The Netherlands
T +31 73 5186488 · F +31 73 5114960
info.benelux@ottobock.com · www.ottobock.nl

Industria Ortopédica Otto Bock Unip. Lda.
Av. Miguel Bombarda, 21 - 2º Esq.
1050-161 Lisboa · Portugal
T +351 21 3535587 · F +351 21 3535590
ottobockportugal@mail.telepac.pt

Otto Bock Polska Sp. z o. o.
Ulica Korolowa 3 · 61-029 Poznań · Poland
T +48 61 6538250 · F +48 61 6538031
ottobock@ottobock.pl · www.ottobock.pl

Otto Bock Romania srl
Șos de Centura Chitila - Mogoșoaia Nr. 3
077405 Chitila, Jud. Ilfov · Romania
T +40 21 4363110 · F +40 21 4363023
info@ottobock.ro · www.ottobock.ro

OOO Otto Bock Service
p/o Pultikovo, Business Park „Greenwood”,
Building 7, 69 km MKAD
143441 Moscow Region/Krasnogorskiy Rayon
Russian Federation
T +7 495 564 8360 · F +7 495 564 8363
info@ottobock.ru · www.ottobock.ru

Otto Bock Scandinavia AB
Koppargatan 3 · Box 623 · 60114 Norrköping · Sweden
T +46 11 280600 · F +46 11 312005
info@ottobock.se · www.ottobock.se

Otto Bock Slovakia s.r.o.
Röntgenova 26 · 851 01 Bratislava 5 · Slovak Republic
T +421 2 32 78 20 70 · F +421 2 32 78 20 89
info@ottobock.sk · www.ottobock.sk

Otto Bock Sava d.o.o.
Industrijska bb · 34000 Kragujevac · Republika Srbija
T +381 34 351 671 · F +381 34 351 671
info@ottobock.rs · www.ottobock.rs

Otto Bock Ortopedi ve
Rehabilitasyon Tekniği Ltd. Şti.
Mecidiyeköy Mah. Lati Lokum Sok.
Meriç Sitesi B Blok No: 30/B
34387 Mecidiyeköy-Istanbul · Turkey
T +90 212 3565040 · F +90 212 3566688
info@ottobock.com.tr · www.ottobock.com.tr

Africa

Otto Bock Algérie E.U.R.L.
32, rue Ahcène Outaleb - Coopérative les Mimosas
Mackle-Ben Aknoun · Alger · DZ Algérie
T +213 21 913863 · F +213 21 913863
information@ottobock.fr · www.ottobock.fr

Otto Bock Egypt S.A.E.
28 Soliman Abaza St. Mohandessein · Giza · Egypt
T +20 2 37606818 · F +20 2 37605734
info@ottobock.com.eg · www.ottobock.com.eg

Otto Bock South Africa (Pty) Ltd
Building 3 Thornhill Office Park · 94 Bekker Road
Midrand · Johannesburg · South Africa
T +27 11 564 9360
info-southafrica@ottobock.co.za
www.ottobock.co.za

Americas

Otto Bock Argentina S.A.
Av. Belgrano 1477 · CP 1093
Ciudad Autónoma de Buenos Aires · Argentina
T +54 11 5032-8201 / 5032-8202
atencionclientes@ottobock.com.ar
www.ottobock.com.ar

Otto Bock do Brasil Tecnica Ortopédica Ltda.
Alameda Maria Tereza, 4036, Bairro Dois Córregos
CEP: 13.278-181, Valinhos-São Paulo · Brasil
T +55 19 3729 3500 · F +55 19 3269 6061
ottobock@ottobock.com.br · www.ottobock.com.br

Otto Bock HealthCare Canada
5470 Harvester Road
Burlington, Ontario, L7L 5N5, Canada
T +1 800 665 3327 · F +1 800 463 3659
CACustomerService@ottobock.com ·
www.ottobock.ca

Oficina Ottobock Habana
Calle 3ra entre 78 y 80.
Edificio Jerusalem · Oficina 112 · Calle 3ra.
Playa, La Habana. Cuba
T +53 720 430 69 · +53 720 430 81
hector.corcho@ottobock.com.br
www.ottobock.com.br

Otto Bock HealthCare Andina Ltda.
Calle 138 No 53-38 · Bogotá · Colombia
T +57 1 8619988 · F +57 1 8619977
info@ottobock.com.co · www.ottobock.com.co

Otto Bock de Mexico S.A. de C.V.
Prolongación Calle 18 No. 178-A
Col. San Pedro de los Pinos
C.P. 01180 México, D.F. · Mexico
T +52 55 5575 0290 · F +52 55 5575 0234
info@ottobock.com.mx · www.ottobock.com.mx

Otto Bock HealthCare LP
11501 Alterra Parkway Suite 600
Austin, TX 78758 · USA
T +1 800 328 4058 · F +1 800 962 2549
USCustomerService@ottobock.com
www.ottobockus.com

Asia/Pacific

Otto Bock Australia Pty. Ltd.
Suite 1.01, Century Corporate Centre
62 Norwest Boulevard
Baulkham Hills NSW 2153 · Australia
T +61 2 8818 2800 · F +61 2 8814 4500
healthcare@ottobock.com.au · www.ottobock.com.au

Beijing Otto Bock Orthopaedic Industries Co., Ltd.
B12E, Universal Business Park
10 Jiuxianqiao Road, Chao Yang District
Beijing, 100015, P.R. China
T +8610 8598 6880 · F +8610 8598 0040
news-service@ottobock.com.cn
www.ottobock.com.cn

Otto Bock Asia Pacific Ltd.
Unit 1004, 10/F, Greenfield Tower, Concordia Plaza
1 Science Museum Road, Tsim Sha Tsui
Kowloon, Hong Kong · China
T +852 2598 9772 · F +852 2598 7886
info@ottobock.com.hk · www.ottobock.com

Otto Bock HealthCare India Pvt. Ltd.
20th Floor, Express Towers
Nariman Point, Mumbai 400 021 · India
T +91 22 2274 5500 / 5501 / 5502
information@indiaottobock.com · www.ottobock.in

Otto Bock Japan K. K.
Yokogawa Building 8F, 4-4-44 Shibaura
Minato-ku, Tokyo, 108-0023 · Japan
T +81 3 3798-2111 · F +81 3 3798-2112
ottobock@ottobock.co.jp · www.ottobock.co.jp

Otto Bock Korea HealthCare Inc.
4F Agaworld Building · 1357-74, Seocho-dong
Seocho-ku, 137-070 Seoul · Korea
T +82 2 577-3831 · F +82 2 577-3828
info@ottobockkorea.com · www.ottobockkorea.com

Otto Bock South East Asia Co., Ltd.
1741 Phaholyothin Road
Kwaeng Chatuchark · Khet Chatuchark
Bangkok 10900 · Thailand
T +66 2 930 3030 · F +66 2 930 3311
obsea@ottobock.co.th · www.ottobock.co.th

Other countries

Otto Bock HealthCare GmbH
Max-Näder-Straße 15 · 37115 Duderstadt · Germany
T +49 5527 848-1590 · F +49 5527 848-1676
reha-export@ottobock.de · www.ottobock.com

Ihr Fachhändler | Your specialist dealer



Otto Bock Mobility Solutions GmbH
Lindenstraße 13 · 07426 Königsee-Rottenbach/Germany
www.ottobock.com

