



Juvo

EN Instructions for use (user) 3

Table of contents

EN

1	Foreword	7
2	Product description	8
2.1	Function	8
2.2	Product Overview	8
3	Safety	9
3.1	Explanation of warning symbols	9
3.2	General safety instructions	10
3.3	Effects of electromagnetic interference on the product and on the user	11
3.4	Nameplate and warning labels	12
3.4.1	Signage on the product	12
3.4.2	Nameplate	12
3.4.3	Warning labels	13
4	Delivery	13
4.1	Scope of delivery	13
4.2	Accessories	13
4.2.1	Accessories from other manufacturers	13
4.3	Storage	14
4.3.1	Storage during daily use	14
4.3.2	Storage during extended disuse	14
5	Preparation for use	15
5.1	Safety instructions	15
5.2	Initial operation	15
5.3	Settings	15
5.3.1	Changing control unit parameters	15
6	Use	16
6.1	Circuit breaker	16
6.2	Side panels	16
6.2.1	Removing/installing the side panels	16
6.2.2	Adjusting the Side Panels	17
6.2.3	Adjusting the control panel position	18
6.3	Legrests	19
6.3.1	Removing/installing the legrests	19
6.3.2	Adjusting the legrests	20
6.4	Backrest	20
6.4.1	Folding the backrest up/down	20
6.4.2	Adjusting the Back Angle	21
6.5	Getting in and transferring	21
6.6	Control unit	22
6.6.1	VR2 control unit	22
6.6.1.1	Control panel	22
6.6.1.1.1	Buttons and display functions	23
6.6.1.2	Control panel	23
6.6.1.2.1	Buttons and display functions	24
6.6.2	R-Net control unit	25
6.6.2.1	TEN° control panel	25
6.6.2.2	Buttons and display functions	26
6.6.2.3	Adjustment possibilities	31
6.6.2.4	Environmental control via Bluetooth	32
6.6.2.4.1	Activating devices	32
6.6.2.4.2	Pairing	33
6.6.2.4.3	Selecting the connected devices	35
6.6.2.4.4	Deactivating devices	35
6.6.2.4.5	Operating mouse functions on a PC	35

6.6.2.4.6	Operating iOS device functions	36
6.6.2.4.7	Operating Android device functions	36
6.6.2.5	Environmental control via infrared (IR)	36
6.6.2.5.1	Operating IR devices.....	36
6.6.2.5.2	Learning and assigning IR codes	37
6.6.2.5.3	Activating and deactivating IR codes	38
6.7	Driving functions	39
6.7.1	Safety instructions.....	39
6.7.2	Driving notes	40
6.7.3	Switching on and off.....	41
6.7.4	Selecting the speed levels.....	42
6.7.5	Driving.....	42
6.7.6	Range.....	43
6.7.7	Anti-tipper	43
6.7.8	Drive-away lock.....	44
6.7.8.1	VR2 control unit	44
6.7.8.2	R-Net control unit.....	44
6.7.9	Adjusting the driving characteristics	45
6.8	Enabling/disabling the brakes.....	45
6.9	Batteries/charging process	47
6.9.1	Safety instructions.....	47
6.9.2	General	47
6.9.3	Battery charging information.....	47
6.9.4	Battery charger.....	48
6.9.5	Charging the battery.....	48
6.10	Seat	50
6.10.1	Safety instructions.....	50
6.10.2	Seat type	50
6.10.3	Contoured pads.....	51
6.10.3.1	Taking off and putting on the covers	51
6.10.3.2	Cleaning the covers	52
6.10.4	Back upholstery	52
6.10.5	ADI back (Baxx line)	52
6.10.6	Seat cushion	53
6.10.7	Recaro® seat	53
6.10.7.1	Settings	53
6.10.7.2	Use	54
6.10.8	Mounting kit for head/neckrests	54
6.10.9	Headrest.....	54
6.11	Power seat functions	55
6.11.1	Safety instructions.....	55
6.11.2	Power seat height adjustment	56
6.11.3	Power seat tilt.....	57
6.11.4	Power back angle adjustment	57
6.11.5	Power legrests.....	58
6.11.6	Controlling power seat functions.....	58
6.11.6.1	VR2 control unit	58
6.11.6.2	R-Net control unit.....	59
6.11.7	Joystick functions	59
6.12	Manual seat functions	60
6.12.1	Safety instructions.....	60
6.12.2	Manually elevating legrests.....	60
6.13	Lap belt	61
6.13.1	Adaptation	61
6.13.2	Use	62
6.14	Control unit accessories	63
6.14.1	Separate LCD monitor.....	63

6.14.2	Control panel for attendant.....	64
6.14.3	Attendant control.....	64
6.14.3.1	VR2 attendant control.....	64
6.14.3.2	R-Net attendant control.....	65
6.14.4	Wireless environmental control.....	67
6.14.5	Special controls.....	67
6.14.6	Push-button control.....	68
6.14.7	Adapter cable for Piko button.....	68
6.14.8	Joystick top.....	68
6.15	Additional options.....	69
6.15.1	Control panel holder.....	69
6.15.2	Lighting.....	69
6.15.2.1	Lighting for road traffic.....	69
6.15.2.2	Lighting (not intended for road traffic).....	70
6.15.3	Belts/belt systems.....	70
6.15.3.1	Adaptation.....	70
6.15.3.2	Use.....	71
6.15.4	Caster wheel swivel lock.....	72
6.15.5	Spring-mounted caster wheel swing arm.....	73
6.15.6	Mechanical track stabiliser.....	73
6.15.7	Electronic track stabiliser.....	73
6.15.8	Luggage carrier.....	74
6.15.9	Curb climbing assist.....	74
6.15.10	External power supply.....	75
6.15.11	Hand heater.....	75
6.15.12	Overview of other options.....	75
6.16	Disassembly and transport.....	76
6.16.1	Safety instructions.....	76
6.16.2	Reducing the transportation size.....	76
6.16.3	Preparing for transport.....	77
6.17	Use in vehicles for transporting persons with reduced mobility.....	77
6.17.2	Prohibited use.....	80
6.18	Care.....	80
6.18.1	Safety instructions.....	80
6.18.2	Cleaning.....	80
6.18.3	Disinfection.....	80
7	Maintenance and repair.....	81
7.1	Safety instructions.....	81
7.2	Maintenance.....	81
7.2.1	Maintenance intervals.....	81
7.3	Repair.....	82
7.3.1	Replacing a defective bulb.....	82
7.3.2	Replacing a battery.....	82
7.4	Troubleshooting.....	83
7.4.1	Types of notifications.....	83
7.4.2	Procedure for warnings and error messages.....	83
7.4.3	Wheelchair control unit error overview.....	83
7.4.4	Attendant control error overview.....	87
8	Disposal.....	88
8.1	Safety instructions.....	88
8.2	Disposal Information.....	88
9	Legal information.....	88
9.1	Liability.....	88
9.2	CE Conformity.....	88
9.3	Warranty.....	88
9.4	Service Life.....	88

10	Technical data	89
11	Appendices	95
11.1	Threshold values for wheelchairs transportable by train	95

1 Foreword

INFORMATION

Last update: 2016-12-19

- ▶ Please read this document carefully before using the product.
- ▶ Follow the safety instructions to avoid injuries and damage to the product.
- ▶ Have yourself instructed by qualified personnel in the proper and safe use of the product.
- ▶ Please keep this document in a safe place.

INFORMATION

- ▶ New information regarding product safety and product recalls can be obtained from the Customer Care Center (CCC) at oa@ottobock.com or from the manufacturer's service department (see inside back cover or back page for addresses).
- ▶ You can request this document as a PDF file from the Customer Care Center (CCC) at oa@ottobock.com or from the manufacturer's service department (see inside back cover or back page for addresses). It is possible to increase the display size of the PDF document.
- ▶ For further questions about the instructions for use, please contact the qualified personnel who issued the product to you.

You have purchased a high-quality product which can be put to versatile, daily use at home and outdoors.

In order to exclude injuries of any type, familiarise yourself with the handling, functions and use of the product before using it. These instructions for use provide the necessary information.

Please note the following in particular:

- All users and/or their attendants must be trained by qualified personnel in the use of the product with the aid of the instructions for use (user). In particular, the user(s) and/or attendant(s) must be informed of the residual risk using the safety instructions in the instructions for use (user).
- The product has been adapted to the needs of the user. Further changes may be made only by qualified personnel. We recommend checking the product settings regularly in order to assure an optimum fit over the long term. For growing children and youths in particular, fitting should be performed every six months.
- In case of questions or problems, please consult the qualified personnel that adapted the product or the manufacturer's service (see inside back cover or back page for addresses).
- The operational safety of the product can only be ensured if it is used properly in accordance with the information contained in these instructions for use. The user is ultimately responsible for accident-free operation.
- Service and repairs to the product may only be carried out by qualified personnel. If you have any problems, please contact your specialist dealer. This ensures that any necessary repairs will be made exclusively with Ottobock spare parts.
- Your product may differ from the models shown.
- The manufacturer reserves the right to make technical changes to the model described in these instructions for use.

2 Product description

2.1 Function

The wheelchair is designed solely for individual use by persons who are unable to walk or who have a walking impediment, and can be operated either by the patient or by another person.

The wheelchair can be used on solid ground both indoors and outdoors.

2.2 Product Overview



- | | | | |
|---|--|----|---------------------------|
| 1 | Backrest | 9 | Caster wheel |
| 2 | Module carrier for control electronics | 10 | Caster wheel splash guard |
| 3 | Side panel with armrest | 11 | Motor with brake release |
| 4 | Back angle adjustment (power adjustment) | 12 | Suspension |
| 5 | Rear lights | 13 | Front light |
| 6 | Drive wheel splash guard | 14 | Legrest |
| 7 | Drive wheel | 15 | Seat cushion |
| 8 | Anti-tipper | 16 | Control panel |

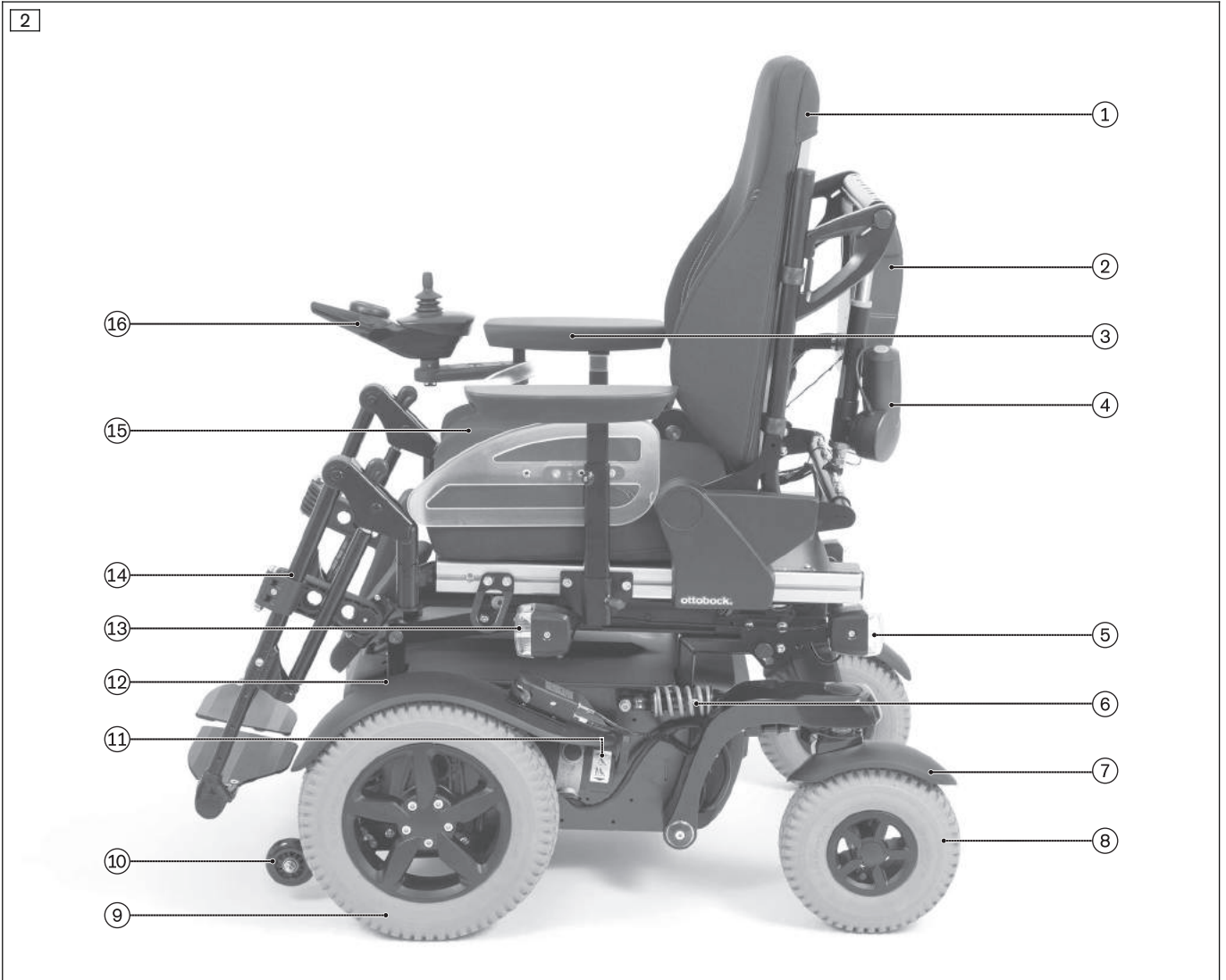

- | | | | |
|---|--|----|--------------------------|
| 1 | Backrest | 9 | Drive wheel |
| 2 | Module carrier for control electronics | 10 | Anti-tipper |
| 3 | Side panel with armrest | 11 | Motor with brake release |
| 4 | Back angle adjustment (power adjustment) | 12 | Drive wheel splash guard |
| 5 | Rear lights | 13 | Front light |
| 6 | Suspension | 14 | Legrest |
| 7 | Caster wheel splash guard | 15 | Seat cushion |
| 8 | Caster wheel | 16 | Control panel |

3 Safety

3.1 Explanation of warning symbols

⚠ WARNING	Warning regarding possible serious risks of accident or injury.
⚠ CAUTION	Warning regarding possible risks of accident or injury.
ℹ NOTICE	Warning regarding possible technical damage.

3.2 General safety instructions

Hazards due to improper use of the product

⚠ WARNING

Improper product operation

Falling, tipping over, collision due to user error

- ▶ The product may only be used by a qualified user.
- ▶ As a user or attendant, you must be trained in the use of the product by qualified personnel instructed by the manufacturer.
- ▶ Read the entire instructions for use.
- ▶ The product may not be used in case of exhaustion or under the influence of alcohol, medications or drugs.
- ▶ The product may **not** be used in road traffic by users who have any mental limitations which can temporarily or permanently limit attentiveness and judgement.
- ▶ You must observe road traffic regulations when driving in road traffic.

⚠ WARNING

Impermissible use

Risk of pinching, crushing, being pulled in, tipping, falling due to improper handling

- ▶ Only use this product for its original intended purpose.
- ▶ Only one person may be transported with the product at any one time.

⚠ WARNING

Overloading

Severe injuries if the wheelchair tips over due to overloading, damage to the product

- ▶ Do not exceed the maximum load capacity (see the nameplate and section "Technical data").
- ▶ Please note that certain options and add-on components will reduce the remaining load capacity.

⚠ WARNING

Exceeding the service life

Serious injuries due to failure to observe the manufacturer's requirements

- ▶ Using the product beyond the specified expected service life (see Page 88) leads to increased residual risk and should only take place subject to the due diligence and deliberations of qualified personnel.
- ▶ If the service life is reached, the user or a responsible attendant should contact the qualified personnel who fitted the product or the manufacturer's servicing department (see inside rear cover or back page for address). Here the user can obtain information about known risks and the current options for refurbishing the product.

⚠ CAUTION

Extreme temperatures

Hypothermia or burns through contact with components, failure of components

- ▶ Do not expose the product to any extreme temperatures (e.g. direct sunlight, sauna, extreme cold).

NOTICE

Use under incorrect environmental conditions

Damage to the product due to excessively high or low temperatures

- ▶ Only use the product within a temperature range of **-15 °C to +40 °C (5 °F to +104 °F)**.

3.3 Effects of electromagnetic interference on the product and on the user

⚠ CAUTION**Use of mobile devices with electromagnetic emissions (e.g., mobile phones)**

Falling, collision with persons or objects due to interference with the control signals

- ▶ Turn all mobile devices off while driving, since the driving characteristics of the product are affected by electromagnetic fields.
- ▶ Turn the control unit off when it is not required, since the product may generate electromagnetic fields that can cause interference with other devices. The product has been tested according to EMC regulations.
- ▶ Notwithstanding compliance with all applicable EMC directives and standards, the product can be affected by interference from other electric devices (e.g., department store EAS systems) or cause interference with such devices. If this occurs, move your product outside the interference range.

- Powered wheelchairs may be susceptible to electromagnetic interference (EMI), which is interfering electromagnetic energy (EM) emitted from sources such as radio stations, TV stations, amateur radio (HAM) transmitters, two-way radios, and cellular phones.
- The interference (from radio wave sources) can cause the powered wheelchair to release its brakes, move by itself, or move in unintended directions.
- It can also permanently damage the powered wheelchairs control system.
- Because EM energy rapidly becomes more intense as one move closer to the transmitting antenna (source), the EM fields from hand-held radio wave sources (transceivers) are of special concern. It is possible to unintentionally bring high levels of EM energy very close to the powered wheelchair's control system while using these devices. This can affect powered wheelchair movement and braking.
- Other types of hand-held devices, such as cordless phones, laptop computers, AM/FM radios, TV sets, CD players, and cassette players, and small appliances, such as electric shavers and hair dryers, so far as we know, are not likely to cause EMI problems to your powered wheelchair.

3.4 Nameplate and warning labels

3.4.1 Signage on the product

The warning signs and nameplates are attached at the following mounting points to the power wheelchair:

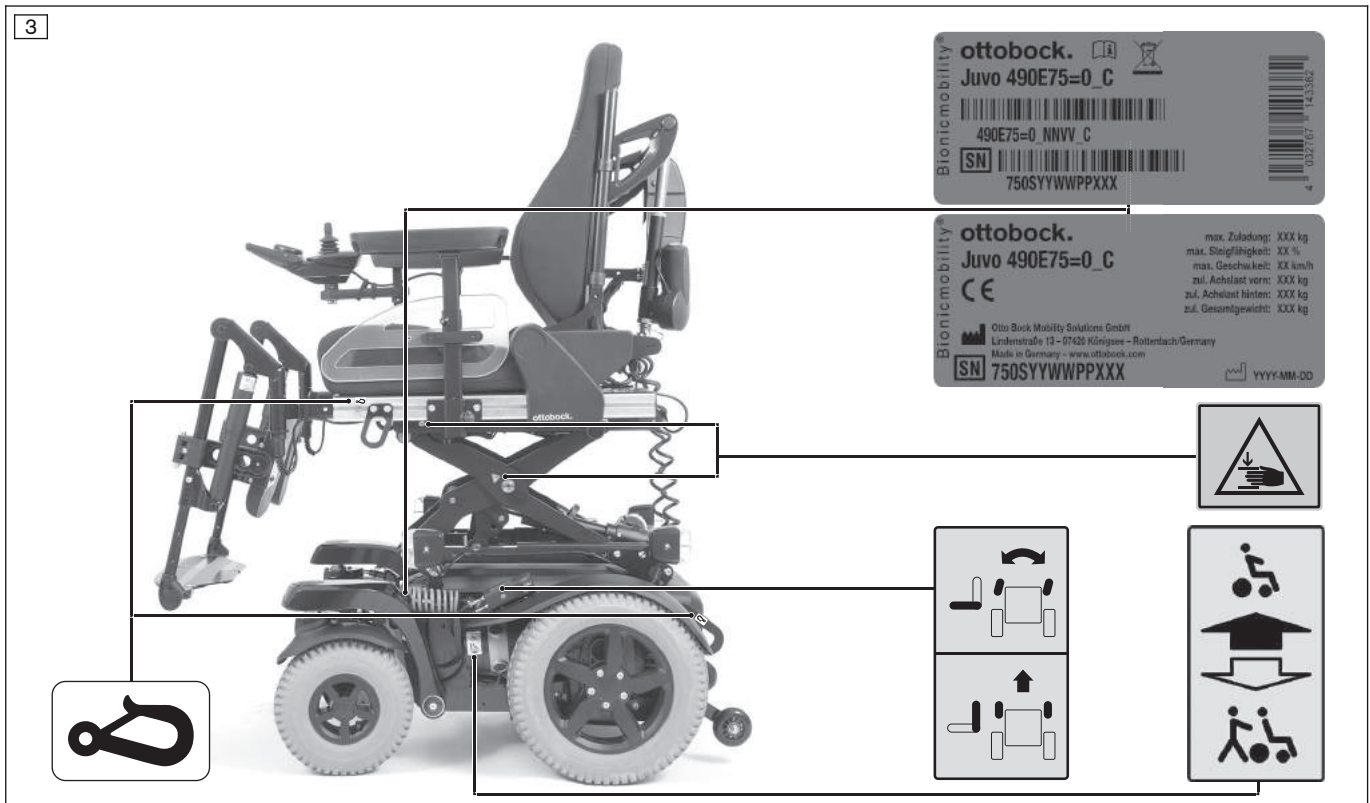

3.4.2 Nameplate

Label	Meaning
A Juvo 490E75=0_C	A Product; product reference number
B [Read manual icon]	B Read the instructions for use before using the product. Observe safety information in the instructions for use.
C [Waste disposal icon]	C Symbol for separate collection of electrical and electronic devices. Components of the power wheelchair and batteries may not be disposed of in household waste.
D 4 032767 143382	D European article number (EAN)
E 490E75=0_NNVV_C	E Product version*
F SN 750SYWPPXXX	F Serial number**
G max. Zuladung: XXX kg	G Maximum load capacity (see section "Technical data")
H max. Steigfähigkeit: XX %	H Maximum climbing ability (see section "Technical data")
I max. Geschwindigkeit: XX km/h	I Maximum speed (see section "Technical data")
J zul. Achslast vorn: XXX kg	J Allowable axle load, front
K zul. Achslast hinten: XXX kg	K Allowable axle load, rear
L zul. Gesamtgewicht: XXX kg	L Maximum gross weight
M Otto Bock Mobility Solutions GmbH Lindenstraße 13 - 07426 Königsee - Rottenbach/Germany Made in Germany - www.ottobock.com	M Manufacturer information/address
N [CE marking]	N CE marking – product safety in accordance with EU directives
O SN 750SYWPPXXX YYY-MM-DD	O Manufacturing date***

The nameplates are found on the mobility base.

* NN = country code; VV = country-specific version; C = configuration

** S = speed code; YY = year of manufacture; WW = week of manufacture; PP = production site; XXX = sequential production number

*** YYY = year of manufacture; MM = month of manufacture; DD = day of manufacture



If the adjacent symbol appears on the nameplate, this indicates the following:
The power wheelchair may **not** be used as a seat in vehicles for transporting persons with reduced mobility.

3.4.3 Warning labels

Label	Meaning
	A Power driving mode: motor brake locked (see Page 45)
	B Manual driving mode: motor brake released (see Page 45)
	A Caster wheel swivel lock: the caster wheels are unlocked and can swivel freely (when ordered)
	B Caster wheel swivel lock: the caster wheels are locked for driving straight ahead (when ordered)
	Risk of pinching. Do not reach into the danger area.
Label	Meaning
	(Only for installation of ISO sets according to ISO 7176) Fixation point/eyebolt to attach the product in vehicles for transporting persons with reduced mobility

4 Delivery

4.1 Scope of delivery

The power wheelchair is normally shipped fully assembled and fitted to the personal requirements of the respective user.

The scope of delivery includes:

- Fitted power wheelchair with main components
- Installed options
- Battery charger
- Instructions for use (user)

4.2 Accessories

The standard model can be fitted to the user's personal requirements thanks to a large range of options.

A full list of the available modules and accessories is shown on the order form and in the accessories catalogue.

For use of the options: see Page et seq.

Please note that retrofitting options further reduces the maximum load capacity (user weight + luggage).

The maximum load capacity (see print on the nameplate; see Page 12) is thereby respectively reduced by the weight of the retrofitted options.

4.2.1 Accessories from other manufacturers

As per the order for the power wheelchair, some components from third-party manufacturers have been installed prior to delivery. Please observe the following instructions in this regard:

- Accessories from other manufacturers must be intended for use on wheelchairs and must fulfil all currently applicable legal requirements under the Medical Devices Act as well as further applicable standards.
- When using the accessories from other manufacturers, the instructions for use / manufacturer's instructions for the relevant accessories must be strictly observed. These are included with the instructions for use.
- Ottobock assumes no liability for combinations with medical devices and/or accessories from other manufacturers not included in Ottobock's modular system.
- In case of questions or problems with accessories from other manufacturers, please contact the qualified personnel who adjusted this product.

4.3 Storage

4.3.1 Storage during daily use

The power wheelchair should always be protected against external influences.

The control unit must be turned off.

4.3.2 Storage during extended disuse

NOTICE

Deep discharge

Battery damage due to standby current

- ▶ Deactivate the circuit breaker if the wheelchair is not used for more than 3 days.
- ▶ To deactivate the circuit breaker: see Page 16

Please observe the following if the power wheelchair is not used for more than **3 days**:

Storage conditions

- Maintain an ambient temperature between **-15 °C and +40 °C (5 °F and +104 °F)** and relative humidity between **45 % and 85 %**.
- Store the power wheelchair in a dry, enclosed room with sufficient air circulation and protection from external influences.
- Protect the wheels against ground frost, e.g. by relieving them completely through assembly blocks or wooden boards.
- Maintain sufficient clearance from sources of heat. If the product is parked for an extended period of time or the tyres overheat (e.g. in the vicinity of radiators or in case of exposure to strong sunlight behind glass), the tyres may become permanently deformed.
- Fill pneumatic tyres with slight overpressure.
- Rotate the wheels weekly to prevent flat tyres from extended standing.
- For extended storage, store the power wheelchair so the wheels are not in contact with the ground.

Note regarding the tyres

- If the power wheelchair is not moved for several days, permanent colour changes may occur where the wheelchair comes into contact with the surface it is standing on. Therefore a suitable mat should be used when parking it for extended periods of time.
- Tyres contain chemical substances that can react with other chemical substances (such as cleaning agents, acids, etc.).
- Black tyres contain soot particles. They may leave black marks where they come into contact with the ground. Therefore the manufacturer recommends grey tyres if the wheelchair is primarily used indoors.
- Avoid unnecessary parking outdoors. Direct exposure to sunlight/UV radiation causes the tyres to age more quickly. As a result, the tread surface hardens and corner pieces break out of the tread.
- The tyres must be changed when the tread is less than **1 mm (0.04")** to ensure safe driving behaviour.
- The tyres should be replaced every **2 years** regardless of wear and tear.
- When power wheelchairs with PU tyres are parked for long periods, the tyres may become deformed (flat spots). This deformation will go away on its own over time while driving.

5 Preparation for use

5.1 Safety instructions

⚠ WARNING

Improper handling of packaging materials

Risk of suffocation due to neglect of the duty to supervise

- ▶ Packaging materials must be kept out of the reach of children.

⚠ WARNING

Independent modification of settings

Serious injuries to the user due to unallowable changes to the product

- ▶ Do not modify the settings established by the qualified personnel.
- ▶ In case of problems with the settings (unsatisfactory seating position, caster wheel wobble, etc.) please contact the qualified personnel who adjusted your product.

⚠ CAUTION

Screw connections not tightened

Pinching, crushing, tipping over, falling of user due to assembly errors

- ▶ After all adjusting/readjusting work authorised by the manufacturer, retighten the mounting screws/nuts firmly. Observe any torque settings which may be specified.

⚠ CAUTION

Uncontrolled movement of components when making adjustments

Crushing, pinching, blows due to non-observance of the maintenance and repair instructions

- ▶ Ensure that body parts, such as hands or head, are never in the danger zone.
- ▶ Perform the work with the aid of a helper for support.

5.2 Initial operation

The specialist dealer ships the power wheelchair fully assembled and ready to use.

The following additional tasks may be required:

- Activating the circuit breaker (see Page 16)
- Folding up the backrest (see Page 20)
- Charging the battery (see Page 48)

5.3 Settings

The user may only perform the fine-tuning adjustments described in the following.

This fine-tuning should be carried out by attendants and only in the presence of the user. The user should sit upright in the power wheelchair while adjustments are made.

- Adjusting the back angle (see Page 21)
- Adjusting the armrests (see Page 17)
- Adjusting the position of the control panel (see Page 18)
- Adjusting the lower leg length (see Page 20)
- Adjusting the lap belt (see Page 61)
- Adjusting the belt lengths (see Page 70)

Further adjustments may be made only by qualified personnel

All parts of the product should be cleaned thoroughly before adjustments are made.

5.3.1 Changing control unit parameters

⚠ WARNING

Incorrect configuration settings

Falling, tipping over, collision due to programming errors

- ▶ Programming may only be performed by qualified personnel trained by the manufacturer. The manufacturer of the product and the control unit manufacturer are not liable in case of damage caused by programming which was not performed properly and/or which was not adjusted properly according to the user's abilities.

If necessary, the qualified personnel can adapt the preprogrammed wheelchair control unit and options to the concrete requirements of the user.

6 Use

6.1 Circuit breaker

INFORMATION

- ▶ Should the automatic circuit breaker deactivate repeatedly after activation for no discernible reason, contact the qualified personnel.
- ▶ For shipping or when the power wheelchair is not being used for an extended period of time, the automatic circuit breaker should be deactivated.

The automatic circuit breaker has to be activated before the power wheelchair can be switched on. It is located under the seat between the drive wheels.

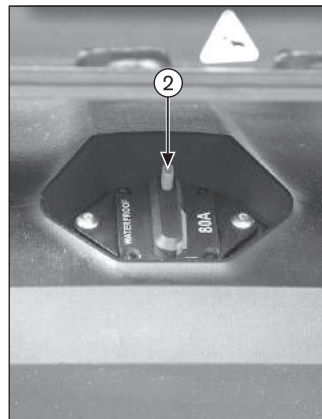
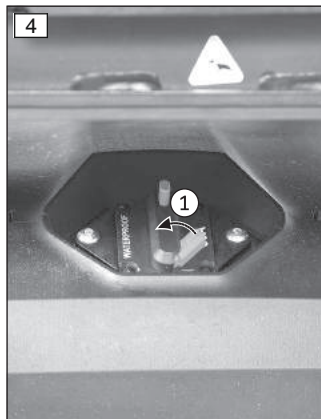

Activating the circuit breaker

- ▶ Close the reset lever, which is at an angle (see fig. 4, item 1).
- The reset lever engages and the circuit breaker is activated.

Deactivating the circuit breaker

- ▶ Press the pushbutton until the reset lever flips up at an angle (see fig. 4, item 2).
- The circuit breaker is deactivated.



Activating the circuit breaker

- ▶ Close the reset lever, which is at an angle (see fig. 5, item 1).
- The reset lever engages and the circuit breaker is activated.

Deactivating the circuit breaker

- ▶ Press the pushbutton until the reset lever flips up at an angle (see fig. 5, item 2).
- The circuit breaker is deactivated.

6.2 Side panels

The side panels protect the user and his/her clothing from getting dirty. The installed armrests offer the user additional support for the forearms.

6.2.1 Removing/installing the side panels

To make getting in from the side easier or for transportation, the side panels can be removed if needed.

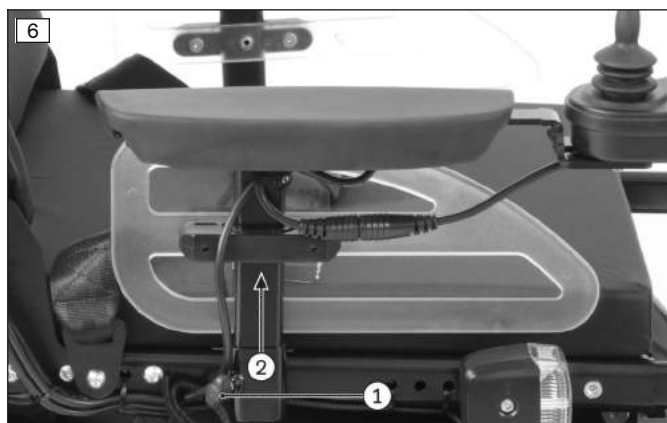

Removing the side panel

- 1) Loosen the thumb screw on the side panel holder (see fig. 6, item 1).
- 2) Pull the side panel out from the side panel holder and set it aside (see fig. 6, item 2).
- 3) Only for side panel with control panel:
 - Turn the control unit off (see Page 22).
 - Carefully let the side panel with the control panel hang down while getting in.
 - For transporting the power wheelchair, place the side panel on the seat.

Installing the side panel

- 1) Insert the side panel into the side panel holder.
- 2) Re-tighten the thumb screw on the side panel holder (see fig. 6, item 1).

To make getting in from the side easier or for transportation, the side panels can be removed if needed.



Removing the side panel

- 1) Loosen the thumb screw on the side panel holder (see fig. 7, item 1).
- 2) Pull the side panel out from the side panel holder and set it aside (see fig. 7, item 2).
- 3) Only for side panel with control panel:
 - Turn the control unit off (see Page 22).
 - Carefully let the side panel with the control panel hang down while getting in.
 - For transporting the power wheelchair, place the side panel on the seat.

Installing the side panel

- 1) Insert the side panel into the side panel holder.
- 2) Re-tighten the thumb screw on the side panel holder (see fig. 7, item 1).

To make getting in from the side easier or for transportation, the side panels can be removed if needed.

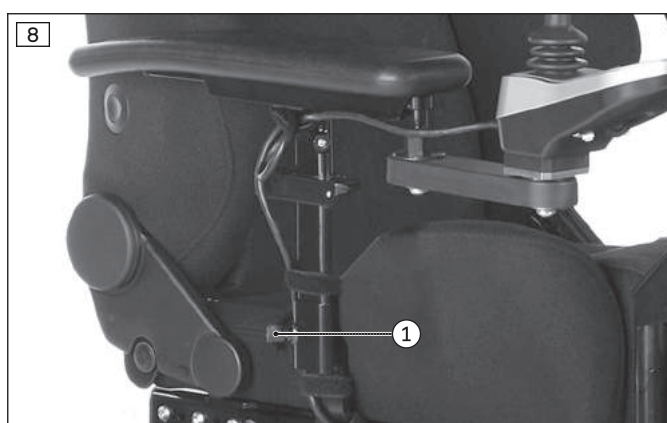

Removing the side panel

- 1) Loosen the thumb screw on the side panel holder (see fig. 8, item 1).
- 2) Pull the side panel out from the side panel holder and set it aside.
- 3) Only for side panel with control panel:
 - Turn the control unit off (see Page 22).
 - Carefully let the side panel with the control panel hang down while getting in.
 - For transporting the power wheelchair, place the side panel on the seat.

Installing the side panel

- 1) Insert the side panel into the side panel holder.
- 2) Re-tighten the thumb screw on the side panel holder (see fig. 8, item 1).

6.2.2 Adjusting the Side Panels

The height of the armrests, the forearm length and the clothing protector can be subsequently adapted.

The height of the armrests, the forearm length and the depth position of the side panel can be subsequently adapted.



Adjusting the armrest height

- 1) Loosen the Allen head screw on the side panel mounting (see fig. 9, item 1).
- 2) Slide the armrests up or down to the desired position.
- 3) Re-tighten the Allen head screw.

Adjusting the armrest to the forearm length

- 1) Loosen the 2 Allen head screws on the underside of the armrest (see fig. 9, item 2).
- 2) Push the armrest to the front or back into the desired position.
- 3) Tighten the 2 Allen head screws.

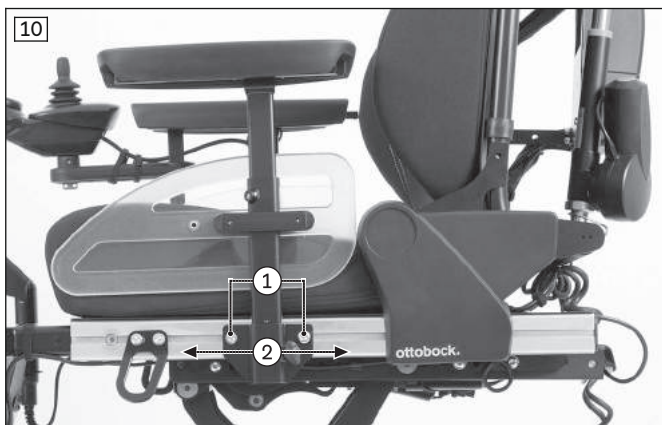

Adjusting the side panel depth

- 1) Loosen the 2 Allen head screws on the side panel mounting (see fig. 10, item 1).
- 2) Slide the side panels on the seat profiles as needed (see fig. 10, item 2).
- 3) Firmly re-tighten the 2 Allen head screws to **6 Nm**.

6.2.3 Adjusting the control panel position

INFORMATION

By default, the control panel is mounted on the side specified in the order. It can also be mounted on the other side of the power wheelchair later on if the user so desires. Please contact the qualified personnel who delivered the product to you.

The depth and height of the control panel position is subsequently adjustable.

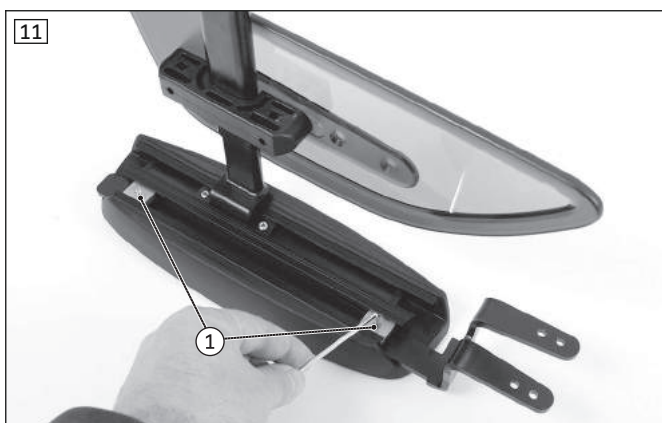

Adjusting the depth of the control panel position

- 1) Loosen the set screws on the bottom of the armrest (see fig. 11, item 1).
- 2) Slide the rail with the control panel forwards or backwards.

INFORMATION: If the control panel rail is too long it can be shortened. Please contact the qualified personnel who adjusted your product.

- 3) Tighten the set screws on the bottom of the armrest.

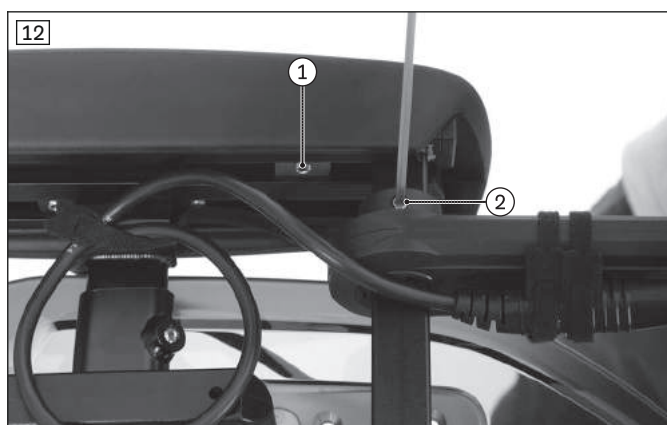

Adjusting the depth of the control panel position

- 1) Loosen the set screws on the bottom of the armrest (see fig. 12, item 1).
- 2) Slide the rail with the control panel forwards or backwards.

INFORMATION: If the control panel rail is too long it can be shortened. Please contact the qualified personnel who adjusted your product.

- 3) Tighten the set screws on the bottom of the armrest.

Adjusting the height of the control panel position

- 1) Loosen the set screw on the height adjustment (see fig. 12, item 2).
- 2) Adjust the height.
- 3) Tighten the set screw on the height adjustment.

6.3 Legrests

INFORMATION

- ▶ Please note that Ottobock has delivered this power wheelchair without legrests as per the order.
- ▶ Prior to using the legrests from another manufacturer, please read and observe the instructions for use / manufacturer's instructions from the other manufacturer. These are included with the instructions for use.
- ▶ In case of questions or problems with these accessories, please contact the qualified personnel who adjusted this product.
- ▶ Ottobock assumes no liability for combinations with accessories from other manufacturers not included in Ottobock's modular system.

The legrests support the user's feet.

The height of the legrests has been adjusted by qualified personnel to the length of the user's lower leg.

The angle of the footrest has been set by the qualified personnel so that it allows the ankles to rest in a comfortable position.

6.3.1 Removing/installing the legrests

⚠ CAUTION

Incorrect handling when getting in

Crushing, pinching, impacts due to incorrect handling

- ▶ Do not reach into the danger area with your fingers when folding the legrest or footplates up or down.
- ▶ Never step on the footplates when getting in and out.
- ▶ Note projecting edges.

INFORMATION

For detaching/attaching the power legrests: see Page 58.

To make getting in easier or for transportation, the legrests can be removed if needed.

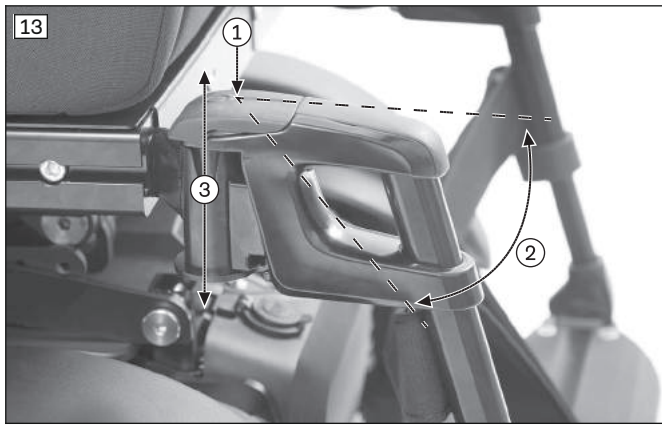

Removing the legrests

- 1) Fold up the footplate.
- 2) Push the legrest locking mechanism back and down (see fig. 13, item 1).
- 3) Swing out the legrest (see fig. 13, item 2).
- 4) Pull the legrest up and remove it (see fig. 13, item 3).

Installing the legrests

- 1) Engage the legrest in the holder straight from above (see fig. 13, item 3).
- 2) Push the legrest to the inside (see fig. 13, item 2) until the locking mechanism engages (see fig. 13, item 1).
- 3) Fold down the footplate.

6.3.2 Adjusting the legrests

⚠ CAUTION

Exposed pinch points

Crushing, pinching due to incorrect handling

- ▶ Do not reach into the danger area with your fingers when folding the legrest or footplates up or down.

The legrests can be subsequently adjusted to the user's lower leg length.



Adjusting the lower leg length

- 1) **If present:** Remove the calf strap (not illustrated).
- 2) Loosen the set screw on the inside of the footplate bar (see fig. 14, item 1).
- 3) Adjust the footplate bar to match the user's lower leg length.
INFORMATION: Ensure that the footplate bar is inserted into the swivel segment up to at least the marking (= 50 mm).
- 4) Retighten the set screw on the footplate bar.
INFORMATION: Always adjust both legrests.
- 5) Hook the calf strap in again.



Adjusting the footplate angle

- 1) Loosen the Allen head screws on the footplate.
- 2) Turn the footplate to the desired angle.
- 3) Tighten the Allen head screws.

6.4 Backrest

The backrest provides pressure redistribution and support for the upper body.

6.4.1 Folding the backrest up/down

The wheelchair may be delivered with the backrest folded down. It has to be folded up and secured prior to use.



Folding up the backrest

- 1) Pull on the strap until the locking bolts are free (see fig. 16, item 1).
- 2) Lift the backrest and move it to the desired position.
- 3) Allow the locking bolts to engage.
- 4) Check to ensure the lock is securely engaged by pulling on the backrest.

Folding down the backrest

- 1) Pull on the strap until the locking bolts are free (see fig. 16, item 1).
- 2) Lay the backrest down on the seat.



Folding up the backrest

- 1) **If needed:** Remove the side panels.
- 2) Fold the backrest up.
- 3) Insert the cotter pin (see fig. 17, item 1).
- 4) Lock the cotter pin (see fig. 17, item 2).
- 5) Check to ensure the lock is securely engaged by pulling on the backrest.
- 6) **If needed:** Reinstall the side panels.

Folding down the backrest

- 1) **If needed:** Remove the side panels.
- 2) Unlock the cotter pin (see fig. 17, item 2).
- 3) Pull out the cotter pin (see fig. 17, item 1).
- 4) Lay the backrest down on the seat.
- 5) **If needed:** Reinstall the side panels.

6.4.2 Adjusting the Back Angle

The back angle can be adapted to the particular needs of the user.

Adjusting the back angle using the strap

- 1) Pull on the strap until the locking bolts are free (see fig. 16, item 1).
- 2) Move the backrest to the desired position.
- 3) Allow the locking bolts to engage.
- 4) Check to ensure the lock is securely engaged.

Power back angle adjustment

The back angle is adjusted as needed by using this seat function (see Page 57).

Recaro® seat

The back angle is adjusted using a knob (see Page 53).

6.5 Getting in and transferring

⚠ CAUTION

Incorrect handling when getting in

Falling, tipping over due to incorrect handling

- ▶ Turn the control unit off while getting in and out, in order to avoid accidental driving.
- ▶ Always place the seat in a horizontal position.
- ▶ Note that the armrests are not capable of bearing full body weight, and therefore must not be used for getting into or out of the wheelchair.
- ▶ Always put on a lap belt when driving.

CAUTION

Incorrect handling when getting in

Crushing, pinching, impacts due to incorrect handling

- ▶ Do not reach into the danger area with your fingers when folding the legrest or footplates up or down.
- ▶ Never step on the footplates when getting in and out.
- ▶ Note projecting edges.

The modular design of the power wheelchair and the ease with which you can remove the side panels and legrests make it easy to get into and out of the wheelchair from the side or from the front.

Users can choose the method for getting into and out of the wheelchair which is most suitable for them.

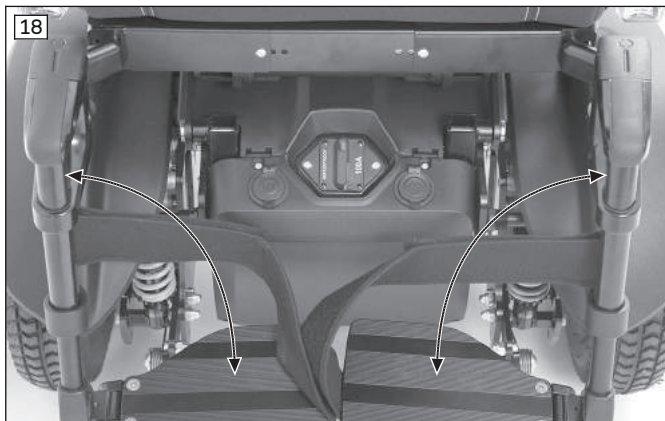

Getting in from the front

- 1) Fold up the footplates (see fig. 18) or remove the legrests (see Page 19).
- 2) Have an attendant assist you or use a transfer lifter to get into and out of the power wheelchair.
- 3) Install the legrests. Fold down the footplates.

Getting in from the side (alternative option)

- 1) Remove or fold up the side panel (see Page 16).
- 2) **If needed:** Remove the corresponding legrest.
- 3) Get into or out of the power wheelchair from the side. A ramp makes this easier.
- 4) Reinstall the legrest and side panel and fold down the footplate.

6.6 Control unit

6.6.1 VR2 control unit

CAUTION

Risk of uncontrolled driving behaviour

Falling, tipping, collision with persons or nearby objects due to interference from electromagnetic fields

- ▶ Switch all mobile devices off while driving.
- ▶ Turn the control unit off when it is not needed.

The power wheelchair is controlled by a VR2 control unit.

Because the control unit is programmable, it can be adapted to the personal requirements of the user; e.g. the speed, acceleration and deceleration values can all be adapted.

6.6.1.1 Control panel

The power wheelchair is operated using the control panel.

The control panel is divided into the keypad, two LED displays and the joystick. The charging/programming receptacle is on the underside.

The control panel is used to switch the power wheelchair on and off, enter driving commands and display the current status of certain functions and components.

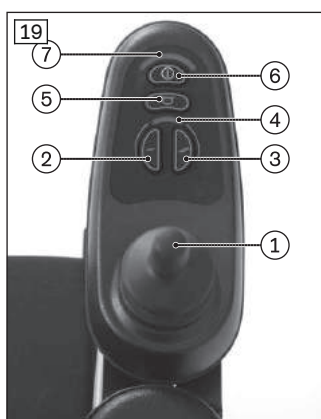

- 1 Joystick
- 2 [Decrease speed] button
- 3 [Increase speed] button
- 4 [Selected speed level] LED display
- 5 [Horn] button
- 6 [On/off] button
- 7 [Charge level] LED display
- 8 Charging/programming receptacle

6.6.1.1.1 Buttons and display functions

Joystick

The speed and driving direction are controlled with the joystick (see Page 42).

[On/off] button

Pressing this button turns the power wheelchair on or off (see Page 41). In combination with additional operating steps, it also activates/deactivates the drive-away lock (see Page 44).

[Decrease speed] and [Increase speed] buttons

Pressing the button briefly increases/decreases the speed level (see Page 42). The acoustic signal changes when the maximum speed level is reached.

[Horn] button

The horn will sound as long as the button is pressed.

[Selected speed level] LED display





The LED display shows the currently selected speed level (1–5).

[Charge level] LED display

The [Charge level] LCD screen is divided into 10 segments and shows the current charge level:

- After brief operation, the battery indicator shows the exact battery status.
- A charge of 100% corresponds to 10 segments on the battery symbol.
- As the remaining battery charge decreases, the LED segments turn off one by one.
- If only one segment of the LED display is flashing, then the battery is in an undervoltage state. The battery must be charged immediately.
- If all 10 LED segments are flashing, this means that the battery is in an overvoltage state. Please continue to drive at low speed only.
- The charging process is indicated by sequential flashing of the LEDs. The driving function is blocked when the battery is charging.

Battery indicator on the control panel

Display	Information
	Battery is charged
	Charge battery if possible
 Sequential indicator	Battery is charging
 Flashing light	Battery undervoltage, battery charging urgently required
 Flashing light	Battery overvoltage

Further LED display functions

Further LED display symbols are described in the following sections:

- See section "Usage" > "Drive-away lock" (see Page 44)
- See section "Maintenance/repair" > "Troubleshooting" (see Page 83)

6.6.1.2 Control panel

The power wheelchair is operated using the control panel.

The control panel is divided into the keypad, two LED displays and the joystick. The charging/programming receptacle is on the underside.

The control panel is used to switch the power wheelchair on and off, enter driving commands and display the current status of certain functions and components.

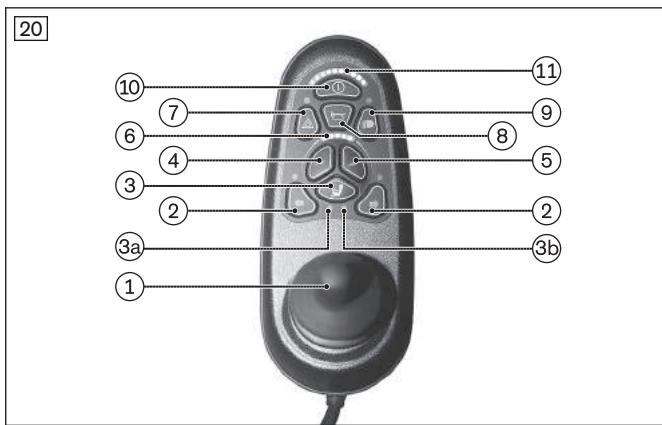

- 1 Joystick
- 2 [Direction indicator left/right] button
- 3 [Select additional power function] button
3a: [Seat function 1] LED display
3b: [Seat function 2] LED display
- 4 [Decrease speed] button
- 5 [Increase speed] button
- 6 [Selected speed level] LED display
- 7 [Warning flasher on/off] button
- 8 [Horn] button
- 9 [Lights on/off] button
- 10 [On/off] button
- 11 [Charge level] LED display
- Charging/programming receptacle (on the back)

6.6.1.2.1 Buttons and display functions

Joystick

The speed and driving direction are controlled with the joystick (see Page 42).

When a power seat option is activated, the joystick adjusts this seat option (see Page 58).

[On/off] button

Pressing this button turns the power wheelchair on or off (see Page 41). In combination with additional operating steps, it also activates/deactivates the drive-away lock (see Page 44).

[Decrease speed] and [Increase speed] buttons

Pressing the button briefly increases/decreases the speed level (see Page 42). The acoustic signal changes when the maximum speed level is reached.

[Select additional power functions] button

Pressing this button toggles through seat function 1 – seat function 2 – no seat function. The selected seat function is indicated by the LEDs.

[Seat function 1/2] LED display

This LED display shows the currently active additional power function.

[Horn] button

The horn will sound as long as the button is pressed.

[Warning flasher on/off] button

All 4 warning flashers are activated/deactivated when this button is pressed.

If the wheelchair is not fitted with lights for road traffic, this button is deactivated (no function).

[Lights on/off] button

The front and rear lights are activated/deactivated by pressing this button.

If the wheelchair is not fitted with lights for road traffic, this button is deactivated (no function).

[Direction indicator right] and [Direction indicator left] buttons

Pressing these buttons activates/deactivates the respective front and rear direction indicators.

If the wheelchair is not fitted with lights for road traffic, this button is deactivated (no function).

[Selected speed level] LED display

The LED display shows the currently selected speed level (1–5).





[Charge level] LED display

The [Charge level] LCD screen is divided into 10 segments and shows the current charge level:

- After brief operation, the battery indicator shows the exact battery status.
- A charge of 100% corresponds to 10 segments on the battery symbol.

- As the remaining battery charge decreases, the LED segments turn off one by one.
- If only one segment of the LED display is flashing, then the battery is in an undervoltage state. The battery must be charged immediately.
- If all 10 LED segments are flashing, this means that the battery is in an overvoltage state. Please continue to drive at low speed only.
- The charging process is indicated by sequential flashing of the LEDs. The driving function is blocked when the battery is charging.

Battery indicator on the control panel

Display	Information
	Battery is charged
	Charge battery if possible
 Sequential indicator	Battery is charging
 Flashing light	Battery undervoltage, battery charging urgently required
 Flashing light	Battery overvoltage

Further LED display functions

Further LED display symbols are described in the following sections:

- Section "Drive-away lock" (see Page 44)
- Section "Power seat functions" (see Page 55)
- Section "Troubleshooting" (see Page 83)

6.6.2 R-Net control unit

CAUTION

Risk of uncontrolled driving behaviour

Falling, tipping, collision with persons or nearby objects due to interference from electromagnetic fields

- ▶ Switch all mobile devices off while driving.
- ▶ Turn the control unit off when it is not needed.

The power wheelchair is controlled by an R-Net control unit.

Because the control unit is programmable, it can be adapted to the personal requirements of the user; e.g. the speed, acceleration and deceleration values can all be adapted.

A separate LCD monitor is also installed (see Page 63).

6.6.2.1 TEN° control panel

The power wheelchair is operated using the control panel.

The control panel consists of a button section, LCD screen and joystick. The charging receptacle and two inputs for external buttons are located on the underside.

The control panel is used to switch the power wheelchair on and off, enter driving commands and display the current status of certain functions and components.

Front side – TEN° control panel

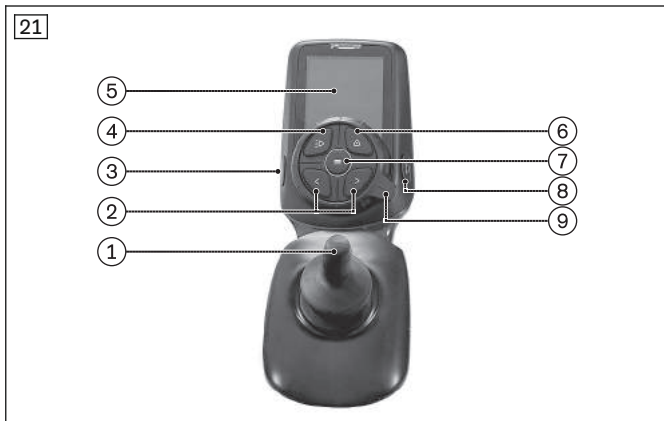

- 1 Joystick
- 2 [Direction indicator left – on/off] button
[Direction indicator right – on/off] button
- 3 [On/off] button
- 4 [Lights on/off] button
- 5 LCD screen
- 6 [Warning flashers on/off] button
- 7 [Profile/mode] button
- 8 [Horn] button
- 9 Rotary multi-selector
right: [Increase speed];
left: [Decrease speed]

Back side – TEN° control panel



- 1 Transmitter for infrared signals
- 2 Charging receptacle
- 3 Connection for external [Profile] or [Profile/mode] button (programmable)
- 4 Connection for external [on/off] button

6.6.2.2 Buttons and display functions

LCD screen

The LCD screen is the communication interface between the user and the control unit. It indicates the selected profile or the selected mode, the battery charge level and the status of power options and special functions as well as warnings and errors.

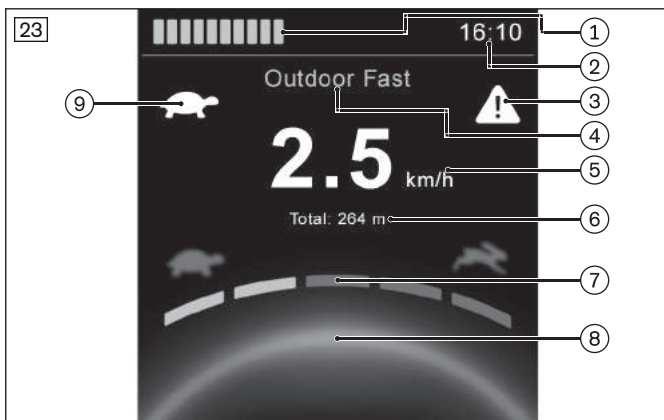





- 1 Display of the battery charge level (see next section)
- 2 Time display
- 3 Warning display (e.g. battery undervoltage)
- 4 Display of the profile name or the modes (e.g. **"Seating"**)
- 5 Display of the travel speed
- 6 Display of the distance travelled
- 7 Display of selected speed level
- 8 Display of active direction indicators (yellow) left/right [On/off]
- 8 Display of active warning flashers (red) [On/off]
- 9 Restricted speed (creep speed)

Battery indicator [Charge level]

The battery indicator [Charge level] is divided into 10 segments and shows the current charge level:

- Immediately after the power wheelchair is switched on, the battery indicator shows the battery charge level that was saved before the wheelchair was last switched off.
- After brief operation, the battery indicator shows the exact battery status.
- A charge level of 100% corresponds to 10 segments on the battery indicator (blue bars).
- As the battery charge level decreases, the segments turn off one by one.
- If the battery indicator shows just red bars, either steady or flashing slowly, the batteries should be charged immediately.
- If the battery is in an undervoltage state, the LCD screen also shows the warning signal because further use will result in battery damage (see Page 83). The battery must be charged immediately.
- If all 10 segments are flashing, this means that the battery is in an overvoltage state. Because further use will result in battery damage, the warning signal is also shown on the LCD screen. Please continue to drive at low speed only.
- The charging process is indicated by the battery segments lighting up one after the other. The driving function is blocked when the battery is charging.

Battery indicator [Charge level] – TEN° control panel

Symbol	Information
	Constant illumination – battery is charged (blue)
	Constant illumination – battery partially charged (orange)
	Slow flashing – charge battery immediately (red)
	Row of lights illuminating individually – charging in progress (red – orange – blue)

Joystick

The speed and driving direction in a driving profile (e.g. "Drive") are controlled with the joystick (see Page 42).

If the control unit is in "Seating" mode, the seat option can be adjusted by moving the joystick forwards/backwards (see Page 58) or switched to the next seat option by moving it left/right.

You can navigate within the operating modes (e.g. "Bluetooth Devices" mode) by moving the joystick forwards/backwards or right/left.

[Direction indicator left – on/off] button; [Direction indicator right – on/off] button

Pressing these buttons activates/deactivates the respective front and rear direction indicators.

If the power wheelchair is not fitted with lights for road traffic, this button is deactivated (no function).

[On/off] button

Pressing this button turns the power wheelchair on or off (see Page 41). In combination with additional operating steps, it also activates/deactivates the drive-away lock (see Page 44).

[Lights on/off] button

The front and rear lights are activated/deactivated by pressing this button.

If the power wheelchair is not fitted with lights for road traffic, this button is deactivated (no function).

[Warning flashers on/off] button

All 4 warning flashers are activated or deactivated when this button is pressed.

If the power wheelchair is not fitted with lights for road traffic, this button is deactivated (no function).





[Profile/mode] button

Pressing this button retrieves the available driving profiles and operating modes of the control system in succession (dependent on programming and connected devices).



The system first switches from one driving profile to the next driving profile (e.g. "Drive"; "Speciality Control"; ...; "No Assist"; "Attendant"). The number of driving profiles is dependent on programming. After reaching the last driving profile, you can switch to the operating modes by pressing the button again.

The programmed operating modes are now toggled through ("Seating"; "Bluetooth Devices"; "IR Menu"; "I/O Module"). The number of operating modes is dependent on programming. The joystick is used to navigate within the operating modes (see above). After reaching the last mode, you can switch back to the first driving profile, "Drive", by pressing the button again.

LCD display for profiles (selection) – TEN° control panel



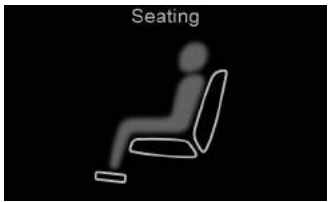



Display	Information
	<p>"Drive" profile Standard driving profile for the TEN° control panel. Among other things, the number of speed levels and the acceleration values are defined here. If there are special requirements for use, other driving profiles can be saved in the control unit.</p>
	<p>"No Assist" profile The driving profile is only enabled for control units with an electronic track stabiliser (gyro). For safety reasons, the user must activate this profile when travelling in means of transportation as the electronic track stabiliser is disrupted by the movement of means of transportation (bus; train; ship).</p>
	<p>"Attendant" profile This profile enables operation of an attendant control. The profile image appears automatically on the LCD screen when the attendant control is activated by the attendant.</p>
	<p>"Specialty Control" profile This profile enables operation of a special control (e.g. chin control, sip and puff control). The profile image appears automatically on the LCD screen when the special control is activated.</p>





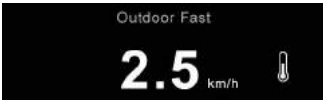
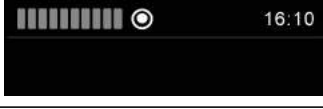

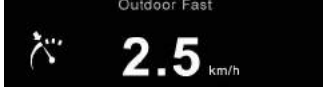

LCD display for operating modes – TEN° control panel

Display	Information
	<p>"Seating" mode This mode enables operation of the power seat functions delivered with the power wheelchair. Further information: see Page 58 ff.</p>
	<p>"Bluetooth Devices" mode This mode enables control of PCs and smartphones/tablets with a Bluetooth function. Mouse functions are operated via joystick movements. The devices being controlled must be synchronised with the control unit prior to use. Further information: see Page 32 ff.</p>
	<p>"IR Menu" mode This mode enables control of devices with infrared remote control – e.g. TV, DVD players, projectors, etc. The devices being controlled must be synchronised with the control unit prior to use. Synchronisation is performed by the qualified personnel. Further information: see Page 36 ff.</p>

Display	Information
	<p>"I/O Module 1" mode – option (designation can be individually adjusted by the qualified personnel)</p> <p>The mode enables wireless control of up to 6 receivers for building services – e.g. power outlets, light switches, blinds, etc.</p> <p>The devices being controlled must be synchronised with the control unit prior to use. Synchronisation is performed by the qualified personnel.</p> <p>The mode alternatively enables use of a push-button module.</p> <p>The mode is only displayed when the option has been ordered.</p> <p>Further information: see Page 67 ff.</p>

Important LCD symbols – TEN° control panel

Display	Information
	Start-up screen when switching on
	Restricted speed (creep speed) Turtle symbol lights up yellow: automatic speed reduction (e.g. because a seat function was activated)
	Restricted speed (creep speed) Turtle symbol flashes red: power wheelchair is prevented from driving
	Temperature warning Thermometer symbol lights up orange: e.g. overheating due to excessive load
	Connected additional input device (if any) Symbol next to the battery indicator lights up green: TEN° control panel is active
	Connected additional input device (if any) Symbol next to the battery indicator lights up red: additional input device is active
	Bluetooth device nearby Bluetooth symbol next to the clock lights up blue: a programmed Bluetooth device is nearby and can be operated with the control panel (see Page 32)
	Constant speed forward/reverse (optional programming) "Latched speed" symbol active: the power wheelchair accelerates up to the desired speed with a forward joystick movement and holds it (like cruise control); the wheelchair brakes when a brief joystick command is executed in the opposite direction; the wheelchair stops when the joystick is moved more than 50% in the opposite direction
	Constant speed forward/reverse (optional programming) Alternative meaning: "Stepped" parameter = with each brief forward joystick movement, the power wheelchair speeds up by one level (e.g. 33%, 66%, 100%) up to the maximum speed level; the wheelchair slows by one level (e.g. from 66% to 33%) when a brief joystick movement is executed in the opposite direction; the wheelchair stops when the joystick is held in the opposite direction
	Emergency stop: severe controller / handheld control unit and/or drive motor malfunction (see Page 83)

Display	Information
<p>Center Joystick</p> 	<p>Joystick not in home position when the unit is turned on (see Page 83)</p>
<p>Warning</p>  <p>FM : 2C00 L1MP FM : 2C00 L1MP</p>	<p>Error message with various information notices (see Page 83)</p>
<p>Lock</p> 	<p>Drive-away lock (see Page 44)</p>
<p>Standby</p> 	<p>The control unit has to be restarted (symbol flashing)</p>
<p>Sleep</p> 	<p>Sleep symbol (control unit shortly switches to sleep mode)</p>
	<p>This symbol is displayed during configuration procedures Procedure successful</p>
	<p>This symbol is displayed during configuration procedures Procedure unsuccessful</p>
<p>Please Wait ...</p> 	<p>This symbol is displayed during configuration procedures Procedure running; please wait</p>
	<p>"Stop button" in latched drive mode (cruise control); the wheelchair brakes when a brief joystick command is executed in the opposite direction; the wheelchair stops when the joystick is moved more than 50% in the opposite direction Alternative: display with special controls</p>

[Horn] button

The horn will sound as long as the button is pressed.

Rotary multi-selector right: [Increase speed]

Moving the rotary multi-selector to the right increases the speed level see Page 42. The acoustic signal changes when the maximum speed level is reached. Depending on the programming of the control system, additional symbols may be displayed when the rotary multi-selector is operated.

Rotary multi-selector left: [Decrease speed]

Moving the rotary multi-selector to the left decreases the speed level see Page 42. The acoustic signal changes when the minimum speed level is reached. Depending on the programming of the control system, additional symbols may be displayed when the rotary multi-selector is operated.

LCD screen

The LCD screen is the communication interface between the user and the control unit. It indicates the selected profile or the selected mode, the battery charge level and the status of power options and special functions as well as warnings and errors.

Further LCD display functions

Further LCD display symbols are described in the following sections:

- Section "Drive-away lock" (see Page 44)
- Section "Power seat functions" (see Page 55)
- Section "Troubleshooting" (see Page 83)

6.6.2.3 Adjustment possibilities

The user can change settings on the display:

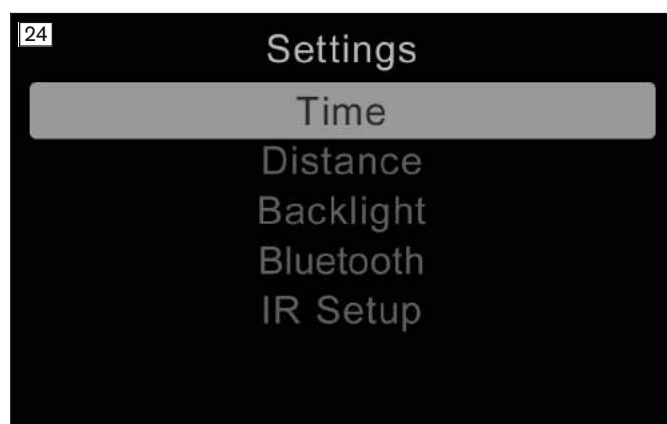

- To retrieve the "Settings" menu, the [Warning flashers on/off] button must be pressed and held.
- To navigate through the menu, move the joystick up and down.
- The desired setting function (e.g. [Time]) is selected by moving the joystick to the right.
- Concrete settings (value changes) are made by further joystick movements up/down or right/left.
- Some settings are made by turning the rotary multi-selector to the left or right (see Page 38).
- To save, select the menu item [Exit] and move the joystick to the right to confirm.

[Time] menu item >

The following submenus are displayed by moving the joystick to the right.

- [Set Time]: The displayed time can be changed with additional joystick movements here.
- [Display Time]: By moving the joystick to the left/right, the time display format can be changed or the display turned off. Adjustable options are [12hr], [24hr] or [Off].
- [Exit]: Return to the **Settings** menu by moving the joystick to the right

[Distance] menu item >

The following submenus are displayed by moving the joystick to the right.

- [Total Distance]: Display of the overall distance travelled with the control unit.
- [Trip Distance]: Display of the distance travelled since the last reset to zero.
- [Display Distance]: Moving the joystick to the left/right determines whether the total distance or trip distance appears on the display.
- [Clear Trip Distance]: The trip distance can be erased by moving the joystick to the right.
- [Exit]: Return to the **Settings** menu by moving the joystick to the right

[Backlight] menu item >

The following submenus are displayed by moving the joystick to the right.

- [Backlight]: The intensity of the LCD backlight can be adjusted by moving the joystick to the left/right. The adjustable range is 0% to 100% in steps of 10%.
- [Autobacklight]: The available options Off and On can be selected by moving the joystick to the left/right. If set to On, the display adjusts the screen brightness based on the light sensor reading. If set to Off, the screen brightness will not change with changes in light intensity.
- [Backlight Timeout]: Automatic dimming of the backlight after a defined time period can be set by moving the joystick to the left/right. The setting is 0 to 240 seconds in increments of 5 seconds. A value of 0 seconds deactivates this function.
- [Exit]: Return to the **Settings** menu by moving the joystick to the right

[Bluetooth] menu item

See the section "Environmental control via Bluetooth" (see Page 32) for further information.

[IR Menu] menu item

See the section "Environmental control via infrared (IR)" (see Page 36) for further information.

[Diagnostics] menu item

For trained, qualified personnel only.

[Exit] menu item

Exit the **Settings** menu by moving the joystick to the right. The display switches to the first driving profile.

6.6.2.4 Environmental control via Bluetooth

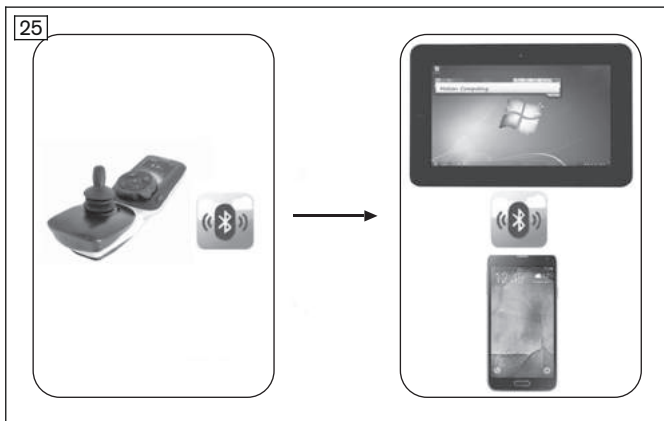

PCs (Windows) and tablets/smartphones (iDevices; Android 4.0 or higher) can be operated in "Bluetooth Devices" mode.

The joystick signals of the TEN° control panel are used to control the device functions.

Mouse functions (mouse movements, right/left click, hold, select) can be executed using brief joystick commands or external buttons.

6.6.2.4.1 Activating devices

Before connecting to a Bluetooth device, the device registration must be activated on the TEN° control panel.

INFORMATION
Only activated device registrations are displayed in Bluetooth mode.

LCD display in "Settings" menu – TEN° control panel

Display	Information
	Select the "Settings" menu by pressing and holding the [Warning flashers on/off] button on the TEN° control panel and choose the [Bluetooth] item: <ul style="list-style-type: none"> • To scroll through the list: joystick front/back • To select registration: joystick to the right
	A list of preprogrammed device names and their respective activation status [On/Off] is displayed. Standard device names are PC, phone, iPhone, iPad. The names can be adjusted by the qualified personnel as desired. <p>Select an appropriate device name for the device being activated.</p>

Display	Information
	Set the activation status to <On>. Restart the control unit afterwards.

6.6.2.4.2 Pairing

Mutual authentication is required prior to initial Bluetooth communication between devices. This procedure, which needs to be carried out once for each device, is called "pairing".

The procedure on the TEN° control panel, which can also be carried out by an attendant if necessary, is described below.

Pairing with a PC

INFORMATION

Because of the various operating system versions, some steps (searching for a Bluetooth device, adding a Bluetooth device, establishing a connection to the Bluetooth device) can only be described in very general terms. Also use the respective operating system help.

To pair with a PC, perform the following steps:

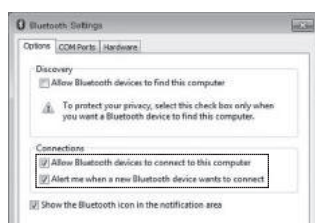

> Prerequisites:

The device registration has been activated (see Page 32).

Bluetooth devices can establish a connection to this computer. If necessary, right-click the Bluetooth symbol on the Windows interface of the PC (in the symbols at the bottom right next to the time) -> Open settings -> Tick checkbox (see Fig. at left).

- 1) Turn on the wheelchair control unit.
- 2) Select the Bluetooth mode on the TEN° control panel by pressing the [Profile/mode] button a number of times if necessary.
→ A list of the available devices is displayed.
- 3) Start the pairing process by selecting a suitable device name, e.g. **Tom's laptop** (To scroll through list: joystick front/back; to select registration: joystick to the right).
→ The laptop symbol is displayed (see Fig. at left).
- 4) Move the joystick forwards for approx. 10 seconds until an acoustic signal sounds.
- 5) Move the joystick back for approx. 10 seconds until an acoustic signal sounds.
→ The Bluetooth symbol at the top of the control panel display (next to the time) should flash. The TEN° control panel is ready to establish a connection.
- 6) Right-click the Bluetooth symbol on the PC (in the symbols at the bottom right next to the time) -> Open settings -> Add device.
- 7) Wait until the device name selected in step 3 is displayed in the "Add device" PC window and confirm. The pairing is now performed.

INFORMATION: If additional Bluetooth devices are nearby, these are also displayed.

- 8) After the device has successfully been added, the Bluetooth symbol is continually displayed in blue on the TEN° control panel and the PC can be operated using the joystick on the control panel or via the connected special control.

INFORMATION: If the connection is not established directly, retrieve the Bluetooth menu once again using the [Profile/mode] button.

Pairing with an Android device

INFORMATION

The details of the steps that follow and the menus that are shown may differ due to the variety of existing Android software versions. Also use the respective Android help.

To pair with an Android device (e.g. smartphone, tablet), complete the following steps:



- > **Prerequisite:** The device registration has been activated (see Page 32).
- 1) Turn on the wheelchair control unit.
- 2) On the Android device, open the **Settings** menu.
- 3) Under the item **Wireless & networks**, open the **Bluetooth** menu item and activate the Bluetooth function.
Alternatively, open the **Bluetooth** menu item directly and activate the Bluetooth function.
- 4) Select the Bluetooth mode on the TEN° control panel by pressing the [Profile/mode] button a number of times if necessary.
→ A list of the available devices is displayed.
- 5) Start the pairing process by selecting a suitable device name, e.g. **Tom's tablet** (To scroll through list: joystick front/back; to select registration: joystick to the right).
→ The tablet symbol is displayed (see Fig. at left).
- 6) Move the joystick forwards for approx. 10 seconds until an acoustic signal sounds.
- 7) Move the joystick back for approx. 10 seconds until an acoustic signal sounds.
→ The Bluetooth symbol at the top of the control panel display (next to the time) should flash. The TEN° control panel is ready to establish a connection.
- 8) Wait until the device name selected in step 5 is displayed on the Android device.
WARNING! If additional Bluetooth devices are nearby, these are also displayed.
- 9) Tap the device name displayed on the Android device to establish the pairing.
- 10) After the device has successfully been added, the Bluetooth symbol is continually displayed in blue on the TEN° control panel and the Android device can be operated using the joystick on the control panel or via the connected special control.

Pairing with an iDevice



To pair with an iOS device (e.g. iPhone, iPad), perform the following steps:



- > **Prerequisite:** The device registration has been activated (see Page 32).
- 1) Turn on the wheelchair control unit.
- 2) Tap **Settings > Bluetooth** on the iOS device. Remain on this screen until the steps for pairing with the TEN° control panel have been completed.
- 3) Select the Bluetooth mode on the TEN° control panel by pressing the [Profile/mode] button a number of times if necessary.
→ A list of the available devices is displayed.
- 4) Start the pairing process by selecting a suitable device name, e.g. **Tom's iPhone** (To scroll through list: joystick front/back; to select registration: joystick to the right).
→ The iPhone symbol is displayed (see Fig. at left).
- 5) Move the joystick forwards for approx. 10 seconds until an acoustic signal sounds.
- 6) Move the joystick back for approx. 10 seconds until an acoustic signal sounds.
→ The Bluetooth symbol at the top of the control panel display (next to the time) should flash. The TEN° control panel is ready to establish a connection.
- 7) Wait until the device name selected in step 4 is displayed on the iOS device.
INFORMATION: If additional Bluetooth devices are nearby, these are also displayed.
- 8) Tap the device name displayed on the iOS device to establish the pairing (see illustration to the left).
- 9) After the device has successfully been added, the Bluetooth symbol is continually displayed in blue on the TEN° control panel and the iOS device can be operated using the joystick on the control panel or via the connected special control.

6.6.2.4.3 Selecting the connected devices

LCD display in Bluetooth mode – TEN° control panel

Display	Information
	The pairing is maintained as soon as the Bluetooth connection to the devices has been established.
	The device can be selected by scrolling (joystick front/back). The selection is confirmed by moving the joystick to the right or left.
	After a few seconds, a Bluetooth symbol is continually displayed in blue on the TEN° screen. The device can now be operated using the control elements of the wheelchair control unit (e.g. joystick, special control).

The ID of the devices to which a Bluetooth pairing has been established is retained in the control panel. This means that the connection can also be reestablished automatically:

- if the wheelchair control unit is switched on again after being switched off,
- if the external device was switched off and on again,
- if the wheelchair has been outside the Bluetooth visibility of the external device and then returns to the visible range again.

6.6.2.4.4 Deactivating devices

- 1) Select the "Settings" menu by pressing and holding the warning flashers button on the TEN° control panel and choose the [Bluetooth] item within the menu.
- 2) Select the device you wish to deactivate from the list of available devices by scrolling (joystick front/back) and confirm your selection by moving the joystick to the right.
 - The device registration is now displayed with the additional information <Off>. The device can be activated again in the same manner. A new pairing is not required.

6.6.2.4.5 Operating mouse functions on a PC

Once a connection has been established to the PC, the mouse pointer can be controlled with the wheelchair control unit.

Mouse movements

The mouse pointer moves according to the movements of the input device (e.g. joystick):

- Mouse movement to the left/right: move joystick at normal speed to the left/right.
- Mouse movement up/down: move joystick at normal speed front/back.

Mouse actions

Mouse actions (such as clicking, scrolling) can be carried out in two ways depending on the equipment.

a) Mouse actions by moving the joystick quickly and briefly:

- Left mouse button function (choose selection): move joystick quickly and briefly to the left.
- Right mouse button function: move joystick quickly and briefly to the right.
- Scroll upwards: move joystick quickly and briefly to the front.
- Scroll downwards: move joystick quickly and briefly to the back.
- Double-click the left mouse button: quickly move the joystick to the left twice in quick succession.
- Double-click the right mouse button: quickly move the joystick to the right twice in quick succession.

The qualified personnel can also change assignments using individual programming so that e.g. a single joystick movement is interpreted as a double-click.

b) Mouse actions using external buttons:

- One button corresponds to the left mouse button, the other button corresponds to the right mouse button.
- Drag-and-drop is operated as with a traditional mouse: press and hold the button and drag with the joystick.

6.6.2.4.6 Operating iOS device functions

The functions of the iOS device can be controlled using short/medium/long joystick movements on the TEN° control panel or corresponding operation of the special control elements. The assignment can be programmed by the qualified personnel.

6.6.2.4.7 Operating Android device functions

As soon as the pairing has been completed, a cursor is superimposed on the display of the Android device. As with a PC, moving the joystick on the TEN° control panel or a connected special control element produces a corresponding cursor movement on the display of the Android device. Device functions such as taking phone calls, selecting contacts, accessing the internet, or sending texts are selected by moving the cursor to the corresponding function and moving the joystick quickly and briefly to the left.

6.6.2.5 Environmental control via infrared (IR)

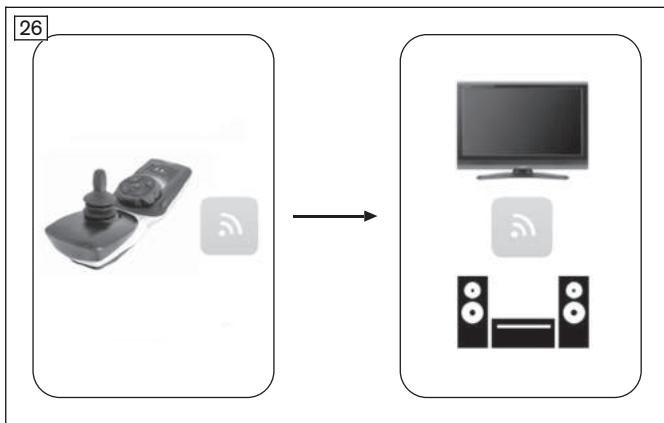

Devices with an infrared remote control (TV, audio, video, projectors, etc.) can be controlled in "IR Menu" mode.

The joystick signals of the TEN° control panel are used to control the device functions.

The device functions must be stored in the control unit using a learning mode or programmed by the qualified personnel using a programming interface.

6.6.2.5.1 Operating IR devices

Retrieving/exiting "IR Menu" mode

The environmental control mode for devices with infrared remote control is retrieved/exited as follows:

- Repeatedly pressing the [Profile/mode] button retrieves the profiles and operating modes in succession (see Page 26; dependent on programming).
- When "IR Menu" mode is reached, the programmed devices can be controlled in the home environment.
- The joystick is used to navigate within "IR Menu" mode (see below).
- Pressing the [Profile/mode] button again allows you to switch to further operating modes and back to the driving profiles again (dependent on programming).



Operating devices

The following commands are provided for navigating within the "IR Menu" using a joystick:

- Moving the joystick forwards moves the selection in the list of controllable devices up.
- Moving the joystick backwards moves the selection in the list of controllable devices down.
- Moving the joystick to the right or left displays the submenu for the corresponding device registration.
- Moving the joystick to the right or left once more triggers the selected control command.

LCD display in "IR Menu" mode – TEN° control panel

Display	Information
	<p>When "IR Menu" mode is selected on the control panel, a list of the devices which can be operated using environmental control is displayed.</p>

Display	Information
	A list of assigned control commands (IR codes) is stored for each device. Using the example of a television set (TV), the following commands are available: [On], [Off], [Volume up], [Volume down], [Mute], [HDMI].
	When the selected command is issued by the control panel, the entry is highlighted red in the list.

6.6.2.5.2 Learning and assigning IR codes

Programming devices

The "IR Menu" mode is only available if commands for controlling devices (IR codes) have been saved in the R-Net control unit. There are two methods for storing IR codes:



- "Learning" the IR code with the help of the corresponding remote control (see below),
- Programming with the PC-based IR configurator (only by qualified personnel).





Learning prerequisites

To allow an optimal learning procedure the following recommendations should be followed:

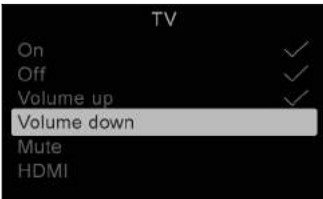
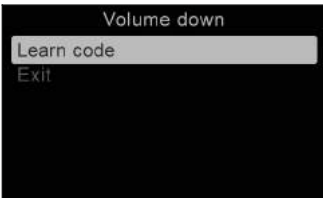
- Put new batteries in the remote control to ensure the IR signal is of good quality.
- Avoid directly exposing the IR sensor to daylight or lamps when signals are being transferred.
- Position the remote control in front of the control panel during the learning process. When pressing a button on the remote control, make sure that the remote control remains still (do not move it back and forth during learning). The ideal distance between the remote control and control panel is in the range between **40 to 100 mm** (1.57" to 3.94").

LCD display in "Settings" menu – TEN° control panel

Display	Information
	Retrieve the "Settings" menu by pressing and holding the [Warning flashers on/off] button on the TEN° control panel. Then select the [IR Setup] menu item within the menu.
	Select a device, e.g. [TV]. The commands which have been set up for the device are displayed.
	Select the command which needs to be learned, e.g. [Volume down].
	Select [Learn code].

Display	Information
	<p>Point the TV remote control towards the control panel and press the desired button (e.g. [Volume down]) twice in succession. The learning mode is displayed on the control panel.</p>
	<p>INFORMATION: Hold the remote control at a distance of 40 to 100 mm (1.57" to 3.94") away from the receiver for infrared signals. The receiver is located on the front side of the control panel above the LCD screen (see arrow).</p>
	<p>A tick mark indicates that the learning process was successful.</p>
	<p>If the learning process was not successful, an X is displayed. Repeat the learning process in this case.</p>

6.6.2.5.3 Activating and deactivating IR codes

The learned IR codes can be activated or deactivated:

- Once an IR code is deactivated, it no longer appears in the user menu. The corresponding command (e.g. [Volume down]) can no longer be transmitted or executed.
- If an IR code is activated, it appears in the user menu. The corresponding command (e.g. [Volume down]) can be transmitted and executed.

LCD display in "Settings" menu – TEN° control panel

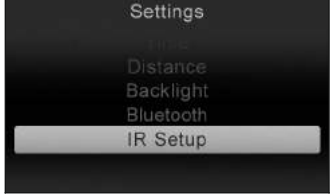
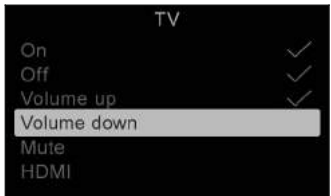
Display	Information
	<p>Retrieve the "Settings" menu by pressing and holding the [Warning flashers on/off] button on the TEN° control panel. Then select the [IR Setup] menu item within the menu.</p>
	<p>Deactivating an IR code An IR code can be deactivated by turning the rotary multi-selector on the TEN° control panel to the left. A deactivated IR code appears with an "X" next to the list entry.</p> <p>Activating an IR code An IR code can be activated by turning the rotary multi-selector on the TEN° control panel to the right. An activated IR code appears with a tick mark next to the list entry.</p>

6.7 Driving functions

6.7.1 Safety instructions

Hazards while driving

CAUTION

Lack of riding experience

Collision, falling due to errors in handling the product

- ▶ Practise using the product on level, open ground first.

CAUTION

Insufficient support of the seated person

Risk of falling out of the power wheelchair due to lack of restraint

- ▶ Always use the installed belt system when driving in public.
- ▶ Information about subsequent acquisition and mounting is provided by the qualified personnel that handed the product over to you.

CAUTION

Uncontrolled driving behaviour, unexpected sounds or odours

Falling, tipping, collision with persons or nearby objects due to defects

- ▶ If any faults, defects or other hazards that can lead to personal injury are detected, the product must be taken out of service immediately. This includes uncontrolled movements as well as sounds that are unexpected or previously not noted or odours that deviate significantly from the state of the product at the time of delivery.
- ▶ Please contact your authorised dealer.

CAUTION

Driving in the dark

Risk of collisions with other traffic participants due to lack of lighting

- ▶ Wear bright clothing or clothing with reflectors.
- ▶ Use the lights on the wheelchair.
- ▶ **If present:** Ensure that the reflectors on the rear marker plate on the product are clearly visible.

Hazards during use of public transportation, elevators, lifting platforms

CAUTION

Use of elevators, lifting platforms

Risk of tipping, collision with persons or nearby objects due to incorrect parking

- ▶ Always turn the power wheelchair control unit off when using elevators or lifting platforms.
- ▶ Make sure that the brake is engaged.

CAUTION

Safe positioning when using public transit

Crushing, pinching, impacts, collision with persons or objects, damage to the product due to human error

- ▶ Only use public transit approved for the transportation of power wheelchairs.
- ▶ Always observe the current applicable transportation guidelines of the transit company and/or the legal requirements in your country when using public transit.
- ▶ Always ensure that you are held in place securely when travelling on public transport. To do so, use the wheelchair areas, wheelchair bays and restraint systems provided. Turn the power wheelchair off before the vehicle starts to move.
- ▶ The transportation of a person sitting in a wheelchair in public transit constitutes a significant safety risk for all participants. We therefore recommend using the seats provided during transportation.
- ▶ While using public transit, you are not permitted to sit in the wheelchair without an approved personal restraint system.

INFORMATION

Only for control units with an electronic track stabiliser (gyro): The electronic track stabiliser is disrupted by the movement of the means of transportation (bus; train; ship) and therefore cannot function. If you must travel short distances in a moving means of transportation, please activate the "No assist" add-on profile. This switches off the electronic track stabiliser.

Hazards due to defective tyres**⚠ CAUTION****Defective tyres**

Accidents/falling due to poor traction, reduced braking force or lack of manoeuvrability

- ▶ Maintain sufficient tyre pressure. The correct air pressure is printed on the sidewall of the tyre.
- ▶ Ensure that the drive wheels have the same pressure.
- ▶ Ensure that the tyres have sufficient tread depth. The tyres must be changed when the tread depth is less than **1 mm**.

Additional information**INFORMATION**

During use of the power wheelchair, electrical discharges (high voltage with low current; discharge via the user) may occur which are caused by factors such as friction. However, these do not represent a health hazard.

Electrostatic discharge may also occur if the power wheelchair is equipped with puncture-proof tires. Retrofitting the wheelchair with pneumatic tires can correct this problem.

6.7.2 Driving notes**General information:**

- Beginners should always drive slowly.
- Always take curves slowly.
- Uncontrolled driving behaviour may occur on uneven ground. Therefore the speed must always be adjusted to the ground conditions.
- Driving backwards should be limited to manoeuvring or short distances on level ground.

Obstacles (steps, curbs, tracks):

- Always approach obstacles directly from the front (never at an angle with only one front wheel).
- Always reduce speed to cross over obstacles (e.g., select speed level 1 or 2).
- Note the information on the critical obstacle height (see the section "Technical data"). Crossing obstacles greater than the height difference specified there is not permitted.
- Avoid jumping down from steps.
- Do not lean out of the wheelchair while crossing obstacles.
- Only cross railway systems and railway tracks in the designated areas.
- Do not negotiate railroad crossings too close to the edge. Otherwise, the wheels could accidentally move off the railroad crossing.
- Stop before the railroad crossing and check to the left and right for safety.

Inclines and downgrades:

- Note the information on permitted inclines and downgrades (see the section "Technical data"). Driving on inclines or downgrades exceeding this percentage is not permitted. The wheelchair may otherwise tilt and not brake safely.
- The control unit and the motors have to be protected against overloading. Therefore, the continuous climbing ability depends on the overall weight (wheelchair weight + user weight + payload) as well as the ground conditions, exterior temperature, battery voltage and driving style of the user. In individual cases, the continuous climbing ability can be significantly lower than the value specified.
- In order to navigate downhill gradients safely, the speed must be reduced according to the slope (e.g. select speed level 1).
- Never drive downhill backwards.

Terrain:

- The speed must be reduced in dangerous areas (e.g. select speed level 1).
- Typical dangerous areas include:
 - Narrow paths along waterways/slopes/cliffs (e.g., quay walls, dikes, etc.)
 - Cramped rooms or areas
 - Steep downgrades (e.g., in the mountains, facing streets)
 - Unsurfaced areas (e.g., on construction sites, intersections, train crossings)
 - Snow-covered or icy areas

Using the control unit:

- The control system always has to be mounted securely and the joystick position must be correct.
- The hand or limb used to operate the joystick should be supported, for example on the side panel arm pad.
- The joystick must not be used as the sole support for the hand or limb, because wheelchair movements and bumps could cause a loss of control.
- If the power wheelchair does not drive at full speed even when the battery is fully charged, the selected speed level should be checked. Contact the qualified personnel if increasing the speed level does not solve the problem.
- The intelligent speed control system minimises the effects of slopes and different types of terrain.

Further instructions for use

- Attaching loads such as backpacks and the like can adversely affect stability. Ottobock recommends using a luggage carrier. If this is not available, backpacks should always be secured to the back frame with the shoulder straps. The maximum load capacity of **5 kg (11 lbs)** should not be exceeded.
- The recommended total width for category B power wheelchairs in an operational state is **700 mm (27.5")**. This specification should ensure unhindered use of escape routes, for example. Please note that the wheelchair dimensions may exceed the recommended value in versions with very large seat widths (for more information see the section "Technical data": see Page 89).
- The wheelchairs in this series fully satisfy the minimum technical requirements for wheelchairs transportable by train. Note however that, due to the variety of variants and settings, not every specific power wheelchair meets all minimum requirements (for more information see the section "Appendix" > "Threshold values for wheelchairs transportable by train": see Page 95).

6.7.3 Switching on and off**⚠ WARNING****Lack of brake functionality**

Falling, tipping over, collision with persons or nearby objects due to lack of inspection

- ▶ Ensure that the brake release lever is in the driving position every time before you drive (see Page 45).
- ▶ Check the control unit display to ensure that the brakes are operational and functional (see Page 83).

⚠ WARNING**Defective safety functions**

Falling, tipping over, collision with persons or nearby objects due to lack of inspection

- ▶ Before every use, ensure that the product and its safety functions are in safe and proper condition.
- ▶ Only use the product if all safety functions, e.g. the automatic brakes, are functional.

INFORMATION

In dangerous situations, the product can be turned off at any time using the on/off button. When the button is pressed, the product brakes immediately and the electrical functions cease. Malfunctions such as an insufficient supply of power to the controls are recognised by the software, triggering an emergency stop or reducing the speed of the product. A warning signal will also sound.

- Pressing the [On/off] button (see Page 22) turns the power wheelchair control unit on or off. The power wheelchair turns off automatically if the control unit has not been used for an extended period of time.
- The power wheelchair brakes automatically and comes to a stop if it is turned off with the [On/off] button while being driven.
- Each time you switch on the control unit, it will return to the previously selected speed level.

- Pressing the [On/off] button (see Page 22) turns the power wheelchair control unit on or off. The power wheelchair turns off automatically if the control unit has not been used for an extended period of time.
- The power wheelchair brakes automatically and comes to a stop if it is turned off with the [On/off] button while being driven.
- Each time you switch on the control unit, it will return by default to the last driving profile used (e.g. "Drive") or to the last mode used (e.g. "Seating").
- The specialist dealer can use the parameter settings to specify the default driving profile or mode of the power wheelchair after it is turned on according to the user's requirements (e.g. in "Drive" profile).

6.7.4 Selecting the speed levels

- The power wheelchair has a programmable number of speed levels (delivery condition = 5 speed levels).
- Pressing the [Decrease Speed] button lowers the speed level.
- Pressing the [Increase Speed] button raises the speed level.
- The pitch of the audible signal changes once the highest or lowest speed level is reached.
- The [Selected speed level] LED display shows the speed level selected.

Display	Information
	Selected speed level = 3

- The power wheelchair has a programmable number of speed levels (delivery condition = 5 speed levels).
- Turning the rotary multi-selector to the right [Increase speed] increases the speed level.
- Turning the rotary multi-selector to the left [Decrease speed] reduces the speed level.
- The pitch of the audible signal changes once the highest or lowest speed level is reached.
- The LCD screen indicates the selected speed level in the driving profile "Drive":

Display	Information
	Selected speed level = 2 (TEN° control panel)

6.7.5 Driving

⚠ WARNING

Driving on unsuitable surfaces

Risk of falling or tipping over due to operator error

- ▶ Do not operate the power wheelchair on very smooth surfaces (e.g. icy surfaces) or very rough surfaces (e.g. gravel or rubble).

⚠ WARNING

Driving on slopes, over obstacles

Falling, tipping over due to user error

- ▶ Only cross obstacles or negotiate ascents or descents that are within the permitted maximums. For more information, see the section "Technical data" (see Page 89).
- ▶ Do not cross over any obstacles while ascending or descending inclines.
- ▶ Avoid embarking and disembarking on inclines and slopes.
- ▶ Do not drive over stairs.

⚠ WARNING

Longer braking distance

Risk of falling, tipping over or collision due to operator error

- ▶ Note that the braking distance is much longer on downgrades than on the level.
- ▶ Also reduce speed when driving downhill (e.g. select speed level 1).

INFORMATION

The control unit of the product switches to a safe mode at elevated temperatures and after driving uphill for extended periods of time, limiting the performance of the product.

The user is able to drive the product out of a hazardous situation at any time. After a short time, the product is fully operational again.

The power wheelchair is controlled by moving the joystick:

- The further the joystick is deflected from the centre position, the faster the power wheelchair will drive in this direction.
- The maximum speed at full deflection of the joystick depends on the selected speed level.
- Releasing the joystick automatically activates the brake function, bringing the power wheelchair to a halt.

The mechanical brakes are activated automatically when the power wheelchair comes to a stop so that it cannot roll.

6.7.6 Range

The following factors influence the range of the product:

- Battery capacity
- Battery age (batteries reach their full capacity only after **approx. 20** charge cycles, and the product can achieve the stated range only then)
- Ambient temperature
- Driving conditions (e.g. terrain profile, condition of surface)
- Charging method
- Type and number of power options
- Overall weight of the wheelchair with selected equipment
- Use of power options
- Body weight of user
- Tyres (air pressure, tyre tread depth)

6.7.7 Anti-tipper

The anti-tipper makes driving safer (see fig. 27). With rear-wheel drive, it prevents the wheelchair from tipping too far backward.

The anti-tipper is mounted so that the ground clearance is at least **50 mm**.



The swing-away, spring-loaded anti-tipper rollers stabilise the front-wheel drive power wheelchair when braking while driving downhill.

They swing back when driving against a curb, for example.

The anti-tipper is mounted so that the ground clearance is at least **50 mm**.

6.7.8 Drive-away lock

6.7.8.1 VR2 control unit

INFORMATION

This function is currently not enabled.

For questions related to enabling it, please consult the qualified personnel that adapted the product or the manufacturer's service (see inside back cover or back page for addresses).

The power wheelchair control unit features an electronic drive-away lock, which is disabled by default.

If the function has been ordered and enabled, the drive-away lock can be activated or deactivated as follows using the control panel:

Activating the drive-away lock

- 1) Press and hold the [On/off] switch while the control unit is turned on.
 - 2) Release the [On/off] button after a beep sounds (approx. 1 second).
 - 3) Push the joystick all the way forward until a beep sounds.
 - 4) Push the joystick all the way back until a beep sounds.
- A long beep confirms that the drive-away lock was activated.
 → The control unit turns itself off.
 → A sequential indicator on the [Selected speed level] LED display indicates that the drive-away lock is active:

Display	Information
Sequential indicator on the "Speed levels" LED display	Drive-away lock

Deactivating the drive-away lock

When the unit is turned on, the [Charge level] LED display is off and the [Selected speed level] LED indicator is in sequential indicator mode.

- 1) Push the joystick all the way forward until a beep sounds.
 - 2) Push the joystick all the way back until a beep sounds.
 - 3) Release the joystick.
- A long beep confirms that the driving function is enabled.
 → The [Charge level] LED indicator is lit.
 → The drive-away lock is deactivated and driving is enabled.

Troubleshooting

The drive-away lock remains active if the joystick is not moved correctly.

- 1) Turn the control unit off in order to deactivate the drive-away lock again.
- 2) Turn the power wheelchair on.
- 3) Deactivate the drive-away lock again.

6.7.8.2 R-Net control unit

INFORMATION

This function is currently not enabled.

For questions related to enabling it, please consult the qualified personnel that adapted the product or the manufacturer's service (see inside back cover or back page for addresses).

The power wheelchair control unit features an electronic drive-away lock. This function is activated/deactivated via the control panel.

Activating the drive-away lock

- 1) Press and hold the [On/off] button while the control unit is turned on.
 - 2) Release the [On/off] button after a beep sounds (approx. 1 second).
 - 3) Push the joystick all the way forward until a beep sounds.
 - 4) Push the joystick all the way back until a beep sounds.
- A long beep confirms that the drive-away lock was activated.
 → The control unit turns itself off.
 → The key symbol on the LCD screen indicates that the drive-away lock is activated:

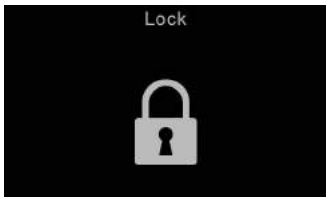
Symbol	Information
	Drive-away lock

Deactivating the drive-away lock

- 1) Push the [On/off] button on the control panel.
 - The control unit is turned on. The LCD screen indicates that the drive-away lock is activated.
- 2) Push the joystick all the way forward until a beep sounds.
- 3) Push the joystick all the way back until a beep sounds.
- 4) Release the joystick.
 - A long beep confirms that the driving function is enabled.
 - The battery indicator and speed level are shown on the LCD screen.
 - The drive-away lock is deactivated and driving is enabled.

Troubleshooting

The drive-away lock remains active if the joystick is not moved correctly.

- 1) Turn the control unit off in order to deactivate the drive-away lock again.
- 2) Turn the power wheelchair on.
- 3) Deactivate the drive-away lock again.

6.7.9 Adjusting the driving characteristics

⚠ WARNING

Incorrect configuration settings

Falling, tipping over, collision due to programming errors

- ▶ Programming may only be performed by qualified personnel trained by the manufacturer. The manufacturer of the product and the control unit manufacturer are not liable in case of damage caused by programming which was not performed properly and/or which was not adjusted properly according to the user's abilities.

Adjusting and setting the speed, acceleration and deceleration values to the individual user requirements is performed exclusively by qualified personnel trained by the manufacturer.

6.8 Enabling/disabling the brakes

⚠ WARNING

Uncontrolled rolling

Risk of collision with persons or nearby objects due to unlocked brake

- ▶ Note the lack of brake functionality when the brake is deactivated. The brake function may only be released in the presence of an attendant.
- ▶ Should the user be unable to release the brake himself, the brake can be released by the attendant.
- ▶ Note that when the power wheelchair is moved on an incline, the attendant must provide the required brake force.
- ▶ Ensure that the wheel lock is engaged each time when parking the power wheelchair.

⚠ WARNING

Improper maintenance, repair, or adjustment work on the brake

Falling, tipping, collision with persons or nearby objects due to improper operation

- ▶ Repairs and adjustments to the brake may only be made by qualified personnel trained by the manufacturer. Incorrect settings can lead to a loss of braking power.

CAUTION

Exposed pinch points

Crushing, pinching due to incorrect handling

- ▶ Grasp the brake release levers as close to the outer end as possible to avoid pinching your fingers between the splash guard and brake release lever.

INFORMATION

When the joystick is activated while the brakes are unlocked, the control unit emits an error signal on the control panel. If this is not the case, something has malfunctioned and the problem must be eliminated immediately by a specialist dealer.

It is possible to push the power wheelchair in case of control unit failure or insufficient battery charge level.

To do so, the brake is deactivated via the mechanical release. The brake releases are located on the right and left of the driving motors.

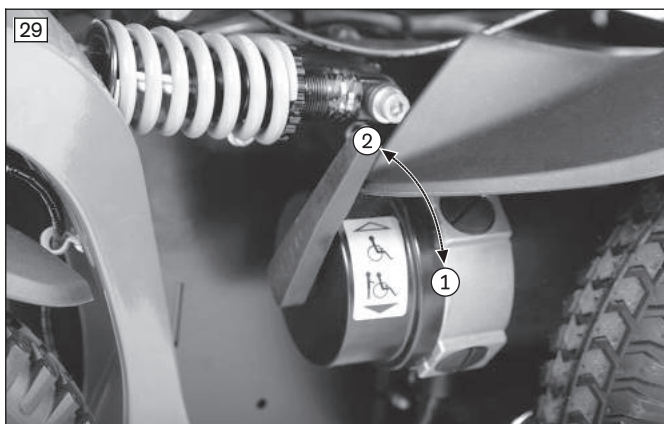

Releasing/deactivating the brake

- 1) If needed: Turn the control unit off.
- 2) Push the brake release levers down (see fig. 29, item 1).
 - The drive motors are released and the power wheelchair has no braking function.
 - After switching the control unit on: The control unit recognises that the brake has been released and deactivates the driving function.
 - A warning appears on the control panel.

Enabling/activating the brake

- 1) If needed: Turn the control unit off.
- 2) Push the brake release lever up (see fig. 29, item 2).
- 3) Switch on the control unit.
 - The driving function is activated.

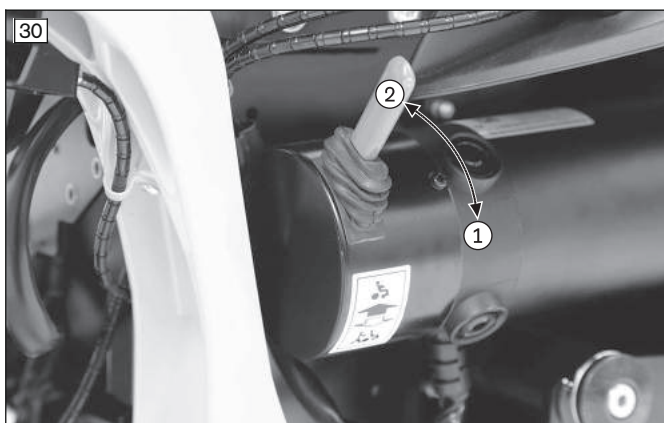

Releasing/deactivating the brake

- 1) If needed: Turn the control unit off.
- 2) Push the brake release levers down (see fig. 30, item 1).
 - The drive motors are released and the power wheelchair has no braking function.
 - After switching the control unit on: The control unit recognises that the brake has been released and deactivates the driving function.
 - A warning appears on the control panel.

Enabling/activating the brake

- 1) If needed: Turn the control unit off.
- 2) Push the brake release lever up (see fig. 30, item 2).
- 3) Switch on the control unit.
 - The driving function is activated.

Brake deactivated: warning on control panel

Display	Information
 Flashing light	Brake released

Brake deactivated: warning on control panel

Display	Information
	Brake released

6.9 Batteries/charging process**6.9.1 Safety instructions****NOTICE****Unauthorised battery replacement**

Battery damage due to unauthorised changes to the product

- ▶ Battery replacement may only be performed by qualified personnel trained by the manufacturer.
- ▶ The charging profile of the battery charger established at the factory matches the batteries included in the scope of delivery and may not be altered independently.

6.9.2 General**INFORMATION**

- ▶ Please note that Ottobock has delivered this power wheelchair without batteries as per the order.
- ▶ Please note that batteries have been installed in your power wheelchair which are not included in Ottobock's modular system. Ottobock assumes no liability for combinations with accessories from other manufacturers not included in Ottobock's modular system.
- ▶ Prior to using this accessory, please read and observe the instructions for use / manufacturer's instructions from the other manufacturer. These are included with the instructions for use.
- ▶ In case of questions or problems with these accessories, please contact the qualified personnel who adjusted this product.

The power wheelchair is equipped with maintenance-free batteries. See the section "Technical data" for the battery capacity.

The batteries are located under the seat of the power wheelchair, below the battery cover.

Prolonged driving when the battery is low results in deep discharge and battery damage. If the power wheelchair is being driven when the battery is low the control unit switches to creep speed to save power.

6.9.3 Battery charging information

The range of the power wheelchair is determined by the battery capacity. The battery capacity is influenced by many factors. In addition to the temperature, battery age and driving conditions, the charging cycle also has a pronounced effect on the capacity and therefore on the range.

Batteries reach their full capacity only after **approx. 20** charge cycles. Only if the full capacity of the batteries has been reached can the power wheelchair achieve the stated range.

At temperatures of **< 0 °C/32 °F** the battery capacity drops by up to **35%** in relation to the capacity for an outside temperature of **20 °C/68 °F**. This shortens the range of the power wheelchair accordingly. Moreover the charge level displayed on the control panel can differ more significantly from the actual battery capacity.

The following information should be observed for an optimal charging cycle:

- The batteries can be charged at any time, regardless of the remaining charge level.
- It takes about **10 hours** until a discharged battery (only 1 flashing segment) is completely charged. When the charging process is complete, the battery charger can remain connected with no risk of overcharging or damaging the battery. The battery charger features a programmed recharging phase that will maintain the battery capacity at the previously reached level.
- If the power wheelchair is used every day, the battery should be charged every night.
- Never discharge the batteries completely (deep discharge).
- The batteries will gradually discharge if the wheelchair is not used for extended periods of time. If the power wheelchair is not used for an extended period, the batteries should be charged **1 x per week** to maintain their capacity.
- After charging the batteries, the circuit breaker should be deactivated if the wheelchair is not used for more than 3 days.
- The power wheelchair control unit must be switched off while the batteries are charging to allow all of the charging current to be fed into the battery.

6.9.4 Battery charger

INFORMATION

- ▶ Please note that Ottobock has delivered this power wheelchair without a battery charger as per the order.
- ▶ Please note that you have received a battery charger which is not included in Ottobock's modular system. Ottobock assumes no liability for combinations with accessories from other manufacturers not included in Ottobock's modular system.
- ▶ Prior to using this battery charger, please read and observe the instructions for use / manufacturer's instructions from the other manufacturer. These are included with the instructions for use.
- ▶ In case of questions or problems with this accessory, please contact the qualified personnel who adjusted this product.

NOTICE

Improper use of the battery charger

Damage to the battery charger, damage to the battery due to user error

- ▶ Only use battery chargers which have been verified and approved for use with the respective batteries.
- ▶ Ensure that the information on the battery charger nameplate matches the country-specific voltage of the respective mains grid.
- ▶ Only use the battery charger within the specified temperature and humidity limits.
- ▶ Place the battery charger on a level surface.
- ▶ If you locate the battery charger near a window, protect it from direct sunlight.
- ▶ Avoid overheating of the battery charger. Do not cover the ventilation slits in the case.
- ▶ Switch the control unit off during the charging process so that all of the charging current is fed into the battery.
- ▶ Avoid dust, dirt and moisture.
- ▶ Only clean the battery charger with a dry cloth.

The battery charger is designed for maintenance-free and low-maintenance batteries.

Please see the instructions for use supplied with the battery charger for further details on use and on the LED displays.

6.9.5 Charging the battery

⚠ WARNING

Discharge of explosive gases during battery charging

Burns due to explosion after a user error

- ▶ Ensure sufficient ventilation in enclosed spaces.
- ▶ Do not smoke or light fires.
- ▶ Sparks must be avoided. Switch the battery charger off and disconnect the mains plug before you disconnect the battery.
- ▶ Do not cover the ventilation slits in the case.
- ▶ Only use battery chargers which have been verified and approved by the manufacturer for use with the respective batteries (observe information on the battery charger). Non-observance may result in explosion of the battery, resulting in a health hazard.

NOTICE

Improper charging

Damage to the battery due to user error

- ▶ Please note the manufacturer's instructions for the batteries being used. Follow the battery manufacturer safety instructions.
- ▶ Avoid deep discharge of the battery. The manufacturer does not assume any liability for damage due to deep discharge.
- ▶ Charge the battery immediately when the control panel indicates a deep discharge (see section "Buttons and display functions").
- ▶ Charge the batteries weekly if the power wheelchair is not used for an extended period of time.



Charging process via the control panel

- 1) Turn the control unit on the power wheelchair off.
- 2) Plug the battery charger plug into the charging receptacle on the power wheelchair control panel.
INFORMATION: Please note that charging via the charging receptacle on the control panel may only be carried out at a current of maximum 10 A.
- 3) Connect the battery charger to the mains socket.
→ The charging process starts automatically, and the battery charge condition is indicated by the LED indicator on the control panel and on the battery charger.
- 4) Turn the battery charger off and pull the plug out of the mains socket when the charging process is complete.
- 5) Disconnect the charging plug from the control panel.
- 6) Turn the power wheelchair control unit on. The power wheelchair is ready to use.



Charging process via the control panel

- 1) Turn the control unit on the power wheelchair off.
- 2) Plug the battery charger plug into the charging receptacle on the power wheelchair control panel.
INFORMATION: Please note that charging via the charging receptacle on the control panel may only be carried out at a current of maximum 10 A.
- 3) Connect the battery charger to the mains socket.
→ The charging process starts automatically and the battery charge level is indicated by the LCD screen on the control panel and on the battery charger.
- 4) Turn the battery charger off and pull the plug out of the mains socket when the charging process is complete.
- 5) Disconnect the battery charger plug from the control panel.
- 6) Turn the power wheelchair control unit on. The power wheelchair is ready to use.



Charging process via the external charging receptacle

- 1) Turn the control unit on the power wheelchair off.
- 2) Open the charging receptacle (see fig. 33).
- 3) Plug the battery charger plug into the charging receptacle.
INFORMATION: Please note that charging via the external charging receptacle may be carried out at a current of up to 12 A.
- 4) Connect the battery charger to the mains socket.
→ The charging process starts automatically and the battery charge level is indicated by the LCD screen on the control panel and on the battery charger.

- 5) Turn the battery charger off and pull the plug out of the mains socket when the charging process is complete.
- 6) Disconnect the battery charger plug from the charging receptacle.
- 7) Close the charging receptacle (see fig. 33).
- 8) Turn the power wheelchair control unit on. The power wheelchair is ready to use.

6.10 Seat

6.10.1 Safety instructions

⚠ WARNING

Seat cushion and back padding may ignite

Burns due to user error

- ▶ The seat and backrest upholstery as well as padding fulfil the requirements for flame resistance according to the norms ISO 8191-2 or DIN EN 1021-2. However, they may still ignite if fire is handled improperly or negligently.
- ▶ Keep away from all ignition sources, especially lit cigarettes.

⚠ CAUTION

Skin damage

Risk of skin reddening during long-term use

- ▶ Do not use the seat until it has been adjusted by a suitably qualified or experienced person.
- ▶ Examine the skin for redness on a regular basis. Skin reddening is a clinical indicator of tissue damage.
- ▶ If redness of the skin or other problems occur during use, stop using the seat immediately. Only start using the seat again after consulting the prescribing doctor or therapist.

⚠ CAUTION

Failure to observe care instructions

Soreness due to user error

- ▶ No seat can completely eliminate sitting pressure or possible soreness.
- ▶ When using the seat, always ensure good skin care and regular pressure relief.

NOTICE

Improper use

Damage to the seat surface due to user error

- ▶ Do not allow the seat to come into contact with sharp objects. This also applies to animals such as pet cats with sharp claws.
- ▶ If the seat is expected to come into contact with liquid, such as spilt drinks or episodes of incontinence, always use it in conjunction with a liquid-repellent cover.
- ▶ Only use the Ottobock incontinence covers for this product. Contact the qualified personnel to obtain a spare Ottobock cover.

6.10.2 Seat type

The product is equipped with a standard seat.



The product is equipped with a VAS seat (Variable Adjust Seat).

This seat type allows the technician to quickly vary the seat depth, seat and back width, and centre of gravity settings.

6.10.3 Contoured pads

The contoured pads provide the user with good lateral support.



The contoured pads are offered in the flat contoured and deep contoured versions. The pads can also be covered in either cloth or artificial leather.

An incontinence cover is available in addition.

Illustrated: Contoured pads in the version with cloth cover, deep contoured.

6.10.3.1 Taking off and putting on the covers

Cloth/artificial leather cover

Before putting on the incontinence cover, the cloth and artificial leather covers have to be taken off the seat pad. In addition, the cloth cover can be taken off the seat and back pads for general cleaning.



Taking off/putting on the cover

- 1) Pull the seat or back pad off the hook-and-loop strap.
- 2) Open the zipper of the cover and remove the foam pad.
- 3) Now the cover can be taken off.
- 4) To put on the cover, insert the foam pad into the cover again with proper alignment.
- 5) Close the zipper and secure the seat or back pad again on the hook-and-loop strap.

Incontinence cover

INFORMATION

Since the artificial leather cover is relatively tight, the incontinence cover is used with the cloth cover as a rule. Nevertheless, you should take the artificial leather cover off from time to time and check whether liquid has gotten into the foam pad through the seams. You should clean the foam pad if this is the case.

The incontinence cover is positioned under the seat cover. It protects the foam pad against wetness.



Putting on the cover

- 1) Remove the cover.
- 2) Slide the foam pad into the incontinence cover (top left).
- 3) Pull the open end of the incontinence cover up and lay it onto the foam pad (top right).
- 4) Pull the overhanging end of the incontinence cover down and close it on the underside of the foam pad (bottom).
- 5) Put on the cover.

6.10.3.2 Cleaning the covers

Cleaning the cloth cover

INFORMATION

- ▶ Replace the cover when it shows signs of advanced wear.
- ▶ Should it be necessary to disinfect the cover, add a standard hygiene detergent during washing (e.g. Sagrotan® laundry hygiene detergent).
- ▶ In case of heavy incontinence, an additional incontinence barrier should be used. Please observe the care and cleaning instructions for each incontinence barrier used.

- 1) Close the zipper on the cover before washing.
- 2) Wash the cover at 60 °C [140 °F] using a mild, environmentally friendly detergent.
Recommendation: Wash the cover using the delicate cycle at **40 °C [104 °F]** to prevent excessive wear.
- 3) Allow to air dry. Do not use a clothes drier.

Cleaning the artificial leather cover

The artificial leather cover does not have to be removed for cleaning.

- 1) Wipe the artificial leather cover by hand using a damp cloth and mild, environmentally friendly detergent. Do not wash in the washing machine.
- 2) Allow to air dry. Do not use a clothes drier.
- 3) **As needed:** For disinfection, wipe damp with a water-based disinfectant.

Cleaning the foam pads

- 1) Hand wash all foam components in warm water at **40 °C [104 °F]** using a standard mild detergent. Do not use fabric softener. Rinse thoroughly.
- 2) Allow to air dry. Do not expose to direct heat sources (e.g. sunlight, stove or radiator).

6.10.4 Back upholstery

INFORMATION

- ▶ Please note that Ottobock has delivered this power wheelchair without back upholstery as per the order.
- ▶ Please note that you have received a back system or back upholstery which are not included in Ottobock's modular system. Ottobock assumes no liability for combinations with accessories from other manufacturers not included in Ottobock's modular system.
- ▶ Prior to using the backrest / back upholstery, please read and observe the instructions for use / manufacturer's instructions from the other manufacturer. These are included with the instructions for use.
- ▶ In case of questions or problems with these accessories, please contact the qualified personnel who adjusted this product.

The backrest is equipped with back upholstery.

The qualified personnel can adjust the backrest upholstery in segments to the needs of the user.

6.10.5 ADI back (Baxx line)

The power wheelchair is equipped with an ADI aluminium flat top back (Baxx line).



With an anatomically shaped rigid back plate made of aluminium, the back system enables the best possible positioning.

Large openings in the back shells provide for a low weight and easy handling.

Detailed information regarding use, cleaning and maintenance can be found in the included instructions for use.

6.10.6 Seat cushion

This power wheelchair was ordered and delivered with a seat cushion.

Wheelchair seat cushions are used for pressure redistribution while sitting. Depending on the version, the seat cushion contains a resilient foam base and, if applicable, additional gel or air-filled inserts. The foam base is anatomically shaped in some cases.

The covers and breathable materials reduce shear forces and ensure a high level of seating comfort for the user.

The seat cushion can be removed for cleaning. Following cleaning, the seat cushion is secured to the seat by a hook-and-loop fastener to prevent sliding.

Detailed information regarding use, cleaning and maintenance can be found in the included instructions for use for the seat cushion.

6.10.7 Recaro® seat

The Recaro® seat provides individually adjustable, comprehensive seating comfort.

6.10.7.1 Settings



Adjusting the back angle

- 1) Turn the knob on the right or left side of the backrest (see fig. 39, item 2).
- 2) Change the backrest angle to the desired position.
CAUTION! Note that the maximum backrest angle is 30° while standing and 20° while driving.

Adjusting the lateral supports in the lumbar region

INFORMATION

This information only applies to the Recaro® LT model.

- 1) Turn the dial on the side of the backrest towards the front.
→ The two lateral supports are moved closer together.
- 2) Turn the dial on the side of the backrest towards the rear.
→ The two lateral supports are moved further apart.

Adjusting the pads

The seat surfaces X and W are equipped with a pull-out pad at the front of the seat bottom. The adjustment lever for the pad is located below the seat bottom.

- 1) Pull the pad adjustment lever up and hold it there.
- 2) Move the pad to the desired position.

- 3) Release the adjustment lever and let it engage. The adjustment lever is in a safe position if it engages audibly and has returned to its initial position.

Adjusting the headrest

The height and tilt angle of the headrest are adjustable.

6.10.7.2 Use



Folding down the backrest (reducing the transport size)

- 1) Pull the release lever up (see fig. 40, item 1).
- 2) Fold the backrest forward or back.
- 3) Let go of the release lever.



Remove the headrest

Two persons are required to remove the headrest.

- 1) 1st person: Find the release points on the Recaro® seat below the cover and push on them both at the same time.
- 2) 2nd person: Pull the headrest up and remove.

6.10.8 Mounting kit for head/neckrests



The mounting kit is used to install head/neckrests. It is mounted to the back frame by means of an adapter.

Detailed information regarding use, maintenance and repair can be found in the included instructions for use.

6.10.9 Headrest

The headrest or head/neckrest stabilises and guides the user's head. It has been mounted to the mounting kit for head/neckrests by qualified personnel.

6.11 Power seat functions

6.11.1 Safety instructions

⚠ WARNING

Driving with power seat functions

Risk of falling or tipping over due to operator error

- ▶ Only drive in road traffic and on inclines and downgrades with the seat tilt and seat height adjustments lowered and with a vertical backrest. Always use a belt system.
- ▶ Slightly tilt the seat to the rear when driving down obstacles in a forward direction (e.g. curbs) and reduce the speed.
- ▶ Drive with the seat raised or with the seat tilt/back angle adjustment activated only for short distances at home. Always use the speed level 1 for this. Note that the field of vision is limited when driving. Always use a belt system.
- ▶ Use the seat height adjustment and the seat tilt only on firm, level ground.

⚠ WARNING

Overloading

Risk of falling, tipping over due to non-compliance with technical data

- ▶ Note that the maximum permitted load of the power wheelchair may be reduced when using power seat functions (see the section "Technical data").

⚠ CAUTION

Exposed pinch points

Pinching, crushing of limbs (e.g. fingers) due to lack of caution in danger areas, damage to the product

- ▶ Note that when seat functions are used, inherent pinch and shear points are located between the seat frame and the power wheelchair frame.
- ▶ Ensure that no body parts, such as hands or feet, are in the danger area while the seat functions are used.
- ▶ Ensure that no interfering objects, such as clothing or other obstacles, are in the danger area while the seat functions are used.

⚠ CAUTION

Overloading of the actuators

Risk of falling, tipping, pinching, crushing of limbs due to improper handling

- ▶ Avoid overloading the actuators. Overloading may cause components to break, leading to uncontrolled dropping of the seat or causing the backrest to flip back.

⚠ CAUTION

Lack of maintenance

Risk of injuries due to maintenance errors, damage to the product

- ▶ Check the adjustment functions for visible signs of damage at least **1 x per month** and ensure all screw connections are tight.

NOTICE

Improper use of electric seat options

Damage to the product through user error

- ▶ When using electric seat options, note that the seat function actuators are not designed for continuous use, only for short-term use under limited loads (10% load, 90% idle time).
- ▶ Observe the following guidelines: at maximum load capacity, 10 seconds of activation time must be followed by approx. 90 seconds of idle time. The power seat functions are considered independently of the driving function for this purpose.
- ▶ Only activate the power seat functions if no fault or error is present.

6.11.2 Power seat height adjustment

⚠ WARNING

Improper use of the seat height adjustment feature

Falling, tipping over due to user error

- ▶ Use the seat height adjustment feature only with the backrest in the upright position.
- ▶ Drive in street traffic only with the seat height adjustment lowered.
- ▶ Even when driving indoors, fasten the belts and do not lean out beyond the seat surface when the seat height adjustment feature is raised.
- ▶ Ensure that creep speed is activated when the seat height adjustment function is used. If this is not the case, contact a specialist dealer immediately. Only use the power wheelchair with the seat height adjustment in its lowest position until the fault is rectified.

NOTICE

Risk of transportation damage

Damage to the product through user error

- ▶ Always lower the seat height adjustment feature fully for loading or transportation.

INFORMATION

- ▶ Also observe the safety instructions in the section "Power seat functions" (see Page 55).
- ▶ Observe the instructions for use in the sections "Controlling power seat functions" (see Page 58) and "Joystick functions" (see Page 59).



The power seat height adjustment feature raises the seat bottom by **350 mm (13.8")** using a motor drive.

The seat can be moved up continuously to the height specified.

The driving function can be used indoors even when the seat is raised. The speed is decreased when the seat is raised.

This is indicated on the control panel as follows:

VR 2 control unit

Display	Information
	Restricted speed (creep speed) INFORMATION: The [Selected speed level] LED display flashes.

R-Net control unit – TEN° control panel

Symbol	Information
	Restricted speed (creep speed) Turtle symbol lights up yellow: automatic speed reduction (e.g. because a seat function was activated)

6.11.3 Power seat tilt

⚠ CAUTION

Incorrect seat tilt handling

Falling, tipping over due to user error

- ▶ Use the seat tilt feature only with the backrest in the upright position.
- ▶ Drive in street traffic only with the seat tilt lowered.
- ▶ When driving with the seat tilt activated, even at home, fasten the belts and do not lean out beyond the seat surface.

INFORMATION

- ▶ Also observe the safety instructions in the section "Power seat functions" (see Page 55).
- ▶ Observe the instructions for use in the sections "Controlling power seat functions" (see Page 58) and "Joystick functions" (see Page 59).

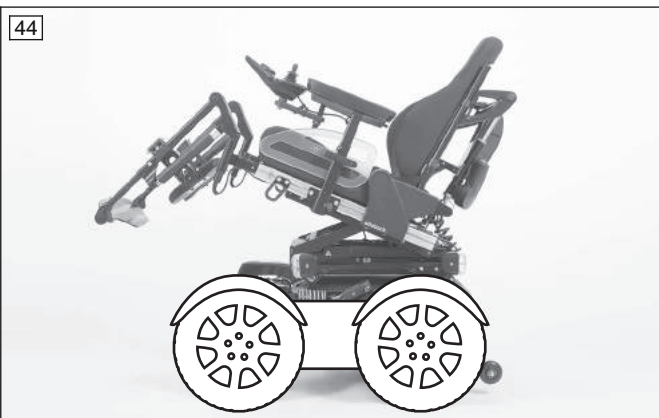

The power seat tilt function allows the seat to be tilted by up to **45°**, for example to relieve pressure (with centre of gravity shift).

The seat can be tilted back continuously to the specified angle.

6.11.4 Power back angle adjustment

⚠ CAUTION

Incorrect use of back angle adjustment

Falling, tipping over due to user error

- ▶ Drive in street traffic only with a vertical backrest.
- ▶ When driving with the back angle adjustment activated, even at home, fasten the belts and do not lean out beyond the seat surface.

INFORMATION

- ▶ Also observe the safety instructions in the section "Power seat functions" (see Page 55).
- ▶ Observe the instructions for use in the sections "Controlling power seat functions" (see Page 58) and "Joystick functions" (see Page 59).

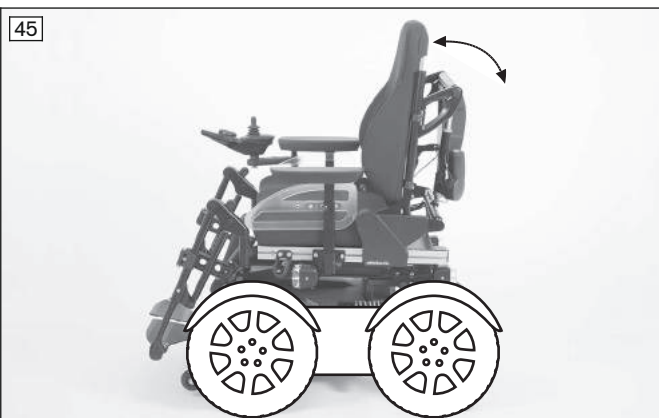

The power back angle adjustment feature enables the backrest to be tilted up to **30°**.

The backrest can be tilted back continuously to the angle specified.

6.11.5 Power legrests

⚠ CAUTION

Incorrect use of the power legrests

Falling, tipping over due to user error

- ▶ Drive in street traffic only with the legrests lowered.

INFORMATION

- ▶ Also observe the safety instructions in the section "Power seat functions" (see Page 55).
- ▶ Observe the instructions for use in the sections "Controlling power seat functions" (see Page 58) and "Joystick functions" (see Page 59).

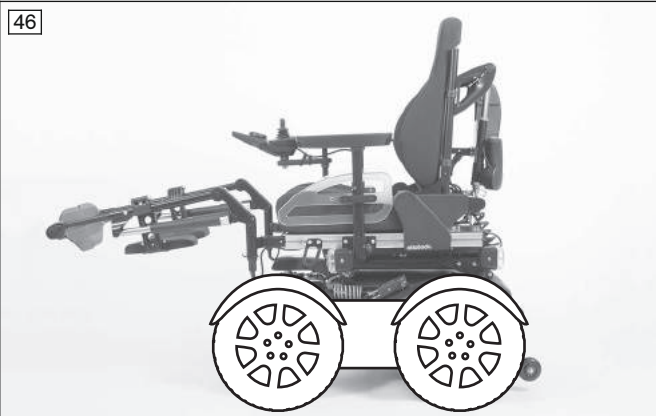

The legrests prevent a constant pressure load or provide anti-shock support.

The legrests can be operated individually or at the same time, depending on the configuration.

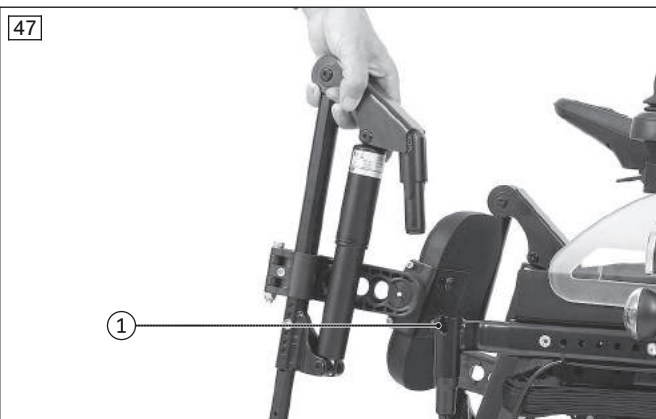

The footrests can be flipped up to increase the entry and exit area.

In addition, the electrically adjustable legrests can be lifted up and out of their brackets (item 1).

6.11.6 Controlling power seat functions

INFORMATION

If your power wheelchair is equipped with an LCD monitor, please also read the section "Separate LCD monitor" (see Page 63).

6.11.6.1 VR2 control unit

- Power seat functions are activated and controlled via the control panel (see Page 23 et seq.).
- The driving function is not available during the activation of a seat function, and the [Selected speed level] LED display turns off.
- A seat function is activated by pressing the [Select additional power options] button. This button toggles through the functions in the order 'Seat function 1' > 'Seat function 2' > 'No seat function'.
- The LED display for the activated seat function lights up when that function is activated. The driving function is not available at this time, and the [Selected speed level] LED display turns off.
- Once a seat function is selected, it is operated by moving the joystick forward or backward.

- The electric motor moves the seat according to the seat function as long as the joystick is deflected and stops at the end positions.
- Press the [Select additional power options] button again to deactivate the seat function after adjusting it. The driving function is available again, and the [Selected speed level] LED display is lit again.

6.11.6.2 R-Net control unit

- Power seat functions are activated and controlled via the control panel (see Page ff.).
- The "Seating" mode is accessed by pressing the [Profile/mode] button. The LCD screen indicates the selected mode (see the following section "Joystick functions"). Depending on programming, the [Profile/mode] button may need to be pressed a number of times.
- Moving the joystick to the left/right switches between the seat functions in "Seating" mode. The LCD screen indicates the currently selected seat function (see the following section "Joystick functions"). The driving function is not available at this time and the speed level indicator switches off.
- Once a seat function is selected, it is adjusted by moving the joystick forward or backward.
- The electric motor adjusts the seat function as long as the joystick is deflected, and stops at the end positions.
- Exit the "Seating" mode by pressing the [Profile/mode] button again. You can now toggle through the driving function or other modes (e.g. Bluetooth mode).

6.11.7 Joystick functions



The following power seat functions can be controlled with the joystick:

VR2 control unit

Function	Joystick deflection (standard setting) ¹⁾
Seat height adjustment	Back: Seat surface moves up Forward: Seat surface moves down
Seat tilt	Back: Seat slowly tips back Forward: Seat slowly tips forward to a horizontal position
Back angle adjustment	Back: Backrest tilts backward Forward: Backrest tilts forward
Legrests	Back: Both legrests move up Forward: Both legrests move down

¹⁾ Direction of movement can be modified by the specialist dealer.

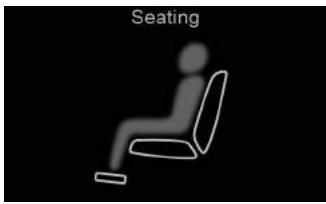
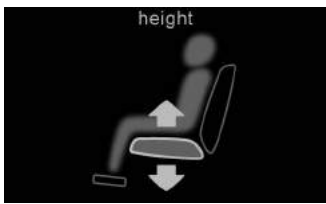
"Seating" mode – TEN° control panel

Display	Function	Joystick deflection (standard setting) ¹⁾
	"Seating" mode start screen This mode enables operation of the power seat functions delivered with the power wheelchair.	Right: Calls up a power seat function* Left: Calls up a power seat function* * consecutively, depending on order
	Power seat height adjustment	Back: Seat surface moves up Forward: Seat surface moves down
	Power seat tilt	Back: Seat slowly tips back Forward: Seat slowly tips forward to a horizontal position

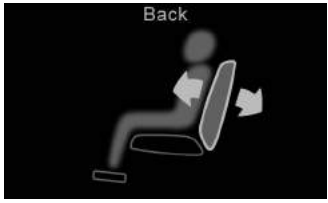
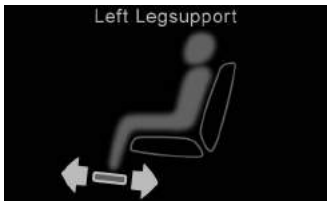
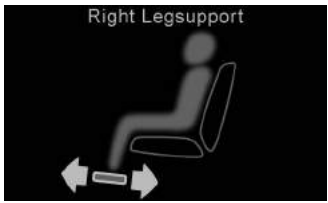
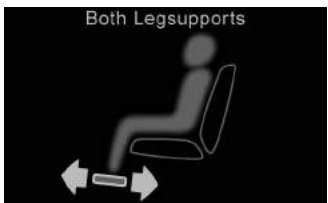
Display	Function	Joystick deflection (standard setting) ¹⁾
	Power back angle adjustment	Back: Backrest tilts backward Forward: Backrest tilts forward
	Power legrest left	Back: The left legrest moves up Forward: The left legrest moves down
	Power legrest right	Back: The right legrest moves up Forward: The right legrest moves down
	Power legrests, coupled	Back: Both legrests move up Forward: Both legrests move down

6.12 Manual seat functions

6.12.1 Safety instructions

⚠ CAUTION

Lack of maintenance

Risk of injuries due to maintenance errors, damage to the product

- ▶ Check the adjustment functions for visible signs of damage at least **1 x per month** and ensure all screw connections are tight.

6.12.2 Manually elevating legrests

INFORMATION

- ▶ Please also observe the safety instructions in the section "Manual seat functions": see Page 60.

The mechanically elevating legrests with a gas compression spring let the user change the angle independently to prevent a constant pressure load or to provide anti-shock support.

48



Pivoting the legrest

- 1) Activate the release lever on the legrest (see arrow).
 - 2) Move the legrest to the desired position.
 - 3) Let go of the release lever.
- The legrest is adjusted.

6.13 Lap belt

The lap belt provides additional stabilisation and prevents the user from sliding out of the seat.

6.13.1 Adaptation

⚠ CAUTION

Improper adjustments

Injuries, malpositions, illness of the user due to adjustment changes

- ▶ The belt system is an important part of an individual seating unit/seating solution. Do not modify the installation position and basic settings established by the qualified personnel.
- ▶ In case of problems with these adjustments (such as an unsatisfactory sitting position), promptly contact the qualified personnel who fitted the product.
- ▶ **Immediately** consult the qualified personnel if you detect signs of discomfort or fear when using the product.
- ▶ Have the basic settings of the belt system checked regularly. Adjustments may be required due to the growth of the user or because of changes in the course of the disease.

Small length adjustments of the belt by the user or an attendant (e.g. for clothing of different thickness) are possible.

The belt length can be adjusted on both sides. Excess belt length is taken up by the plastic slider.

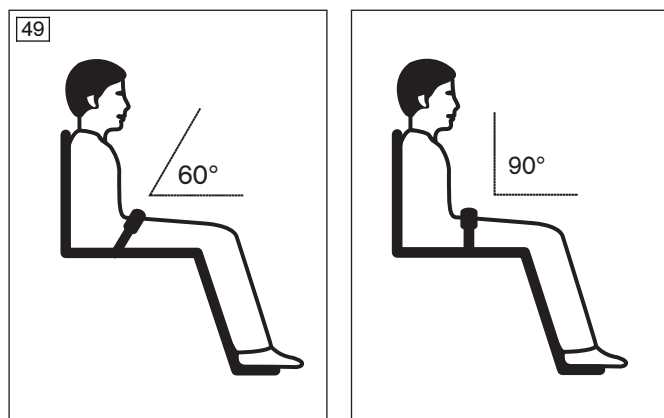

Positioning the user in the seat

- Place the user in an upright, 90° seated position (if physiologically possible).
- Ensure that the back is up against the backrest padding (if physiologically possible).
- The lap belt should be at an angle of about 60° to 90° to the seat surface and run in front of the pelvic bone.

Possible positioning errors

- The lap belt is positioned above the pelvis of the user in the area of the soft part of the stomach.
- The user does not sit upright in the seat.
- If the lap belt is too loose, the user can shift/slide out to the front.
- During the installation/adjustment, the lap belt is routed over parts of the seating system (e.g. over armrests or seat pads). This causes the lap belt to lose its retaining function.

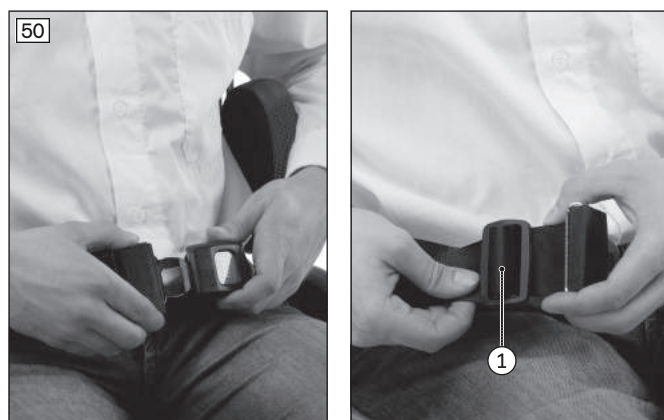

Adjusting the belt length

- 1) Position the user in the seat. Follow the positioning instructions in the previous section to do so.
- 2) Close the belt.
- 3) Position the 2 halves of the buckle in front of the upper body, centred over the thighs.
- 4) Position the respective half of the buckle at a right angle (see fig. 50, item 1).
- 5) Slide the 2 halves of the closure to the desired position.
- 6) Release the respective half of the buckle.
- 7) Verify the adjustment.

WARNING! The lap belt has to fit closely but not too tightly so the user is not injured. It should be possible to slide two fingers comfortably between the strap and thigh.

6.13.2 Use

⚠ WARNING

Incorrect application

Throttling, suffocation or strangulation due to sliding forward in the product

- ▶ The lap belt must be put on when getting into the product and used at all times while using the product.
- ▶ Ensure that the buckle lies in the middle of the body.
- ▶ Remove any objects or clothing which get caught.

⚠ CAUTION

Improper use

Falls, user falling out due to improper use

- ▶ Only open the lap belt when the user is ready to get out of the product.
- ▶ Do not leave the user unsupervised if the cognitive abilities of the user could lead to unintentional opening of the belt system.
- ▶ Information about subsequent acquisition and mounting is provided by the qualified personnel that handed the product over to you.

⚠ CAUTION

Medical risks

Injuries, pressure sores due to application errors

- ▶ Regular measures for pressure redistribution and skin examinations are required. Should skin irritation and/or skin reddening occur, consult the qualified personnel who adapted and adjusted the product. Do not continue using the product without consultation.



Applying the lap belt

> **Prerequisite:** Note the positioning instructions in the previous section.

- 1) Push the 2 halves together until the buckle engages with an audible click.

WARNING! The lap belt has to fit closely but not too tightly so the user is not injured. It should be possible to slide two fingers comfortably between the strap and thigh.

- 2) Pull to check that it is secure.

Opening the lap belt

- 1) Press the release button.
- 2) Open the belt buckle and lay the belt to the side.

Cleaning the belt system

INFORMATION

Observe the washing recommendations on the product and the information in the corresponding instructions for use provided for the product.

- Belts with metal snaps may **not be washed in washing machines** as the penetration of water could cause corrosion and subsequent malfunctions.
- Clean the belt straps by gently dabbing them with warm soapy water (with some disinfectant) or carefully wiped with a dry, clean, absorbent cloth.

Additional cleaning instructions

- Allow the belts to air dry. Ensure that the belts and pads are completely dry before installation.
- Do not expose the belts to direct heat (e.g. sunshine, stove or radiator).
- Do not iron or bleach the belts.

6.14 Control unit accessories

6.14.1 Separate LCD monitor

INFORMATION

More detailed information and operating instructions are contained in a separate manual. Please contact the qualified personnel who adjusted your product.

The power wheelchair is equipped with a separate LCD monitor (omni-module).

- The LCD monitor allows the control functions to be displayed separately. The LCD monitor displays the current statuses of all power functions and electrical components, as well as faults and malfunctions.

LCD monitor with menu

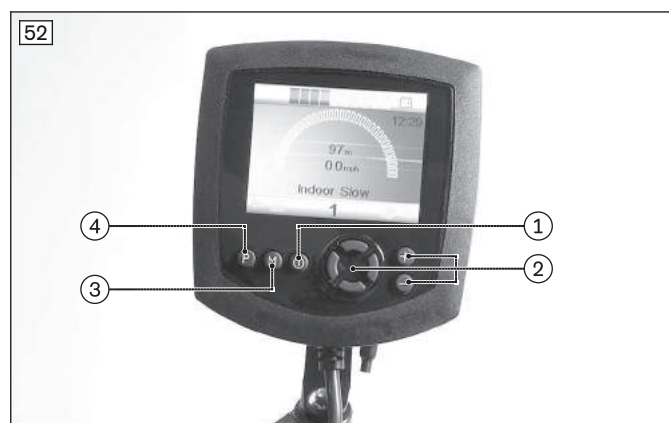





- 1 [On/off] button
- 2 Navigation buttons
- 3 [Mode] button
- 4 [Profiles] button

Functions of the monitor buttons

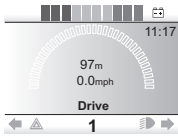
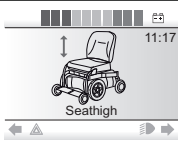
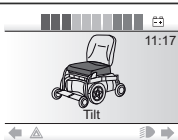
- [On/off] button:** Pressing this button turns the power wheelchair on or off and activates/deactivates the drive-away lock. After powering up, the LCD monitor displays the menu (see below).
- Only with installed special control:**
 - Navigation buttons:** The qualified personnel can make changes in the settings with these buttons.
 - [Mode] button:** Pressing this button toggles through the programmed operating modes ("Drive" > "Power seat functions" > "Bluetooth" ...). After reaching the last mode, you can switch back to the first mode by pressing the button again. The joystick is used to navigate within the operating modes (see there).
 - [Profiles] button:** Briefly pressing the button switches from one profile to the next profile (e.g. "Standard"; "Specialty Control"; ... ; "No Assist"; "Attendant" -> dependent on programming). After reaching the last profile, you can switch back to the first profile by pressing the button again.

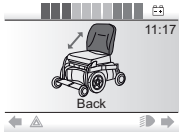
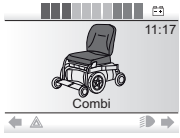
Important displays on the LCD monitor

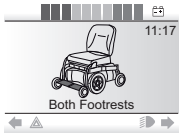
Display	Information
	Programmed driving profile (e.g. driving profile 1: "Drive")
	Power seat height adjustment (optional)
	Power seat tilt (optional)

Display	Information
	Power back angle adjustment (optional)
	Special functions (optional; here combined seat height adjustment and seat tilt)
	Power legrest left (optional)
	Power legrest right (optional)
	Power legrests coupled (optional)
	Creep speed: When adjusting the seat height and when the seat is tilted at a large angle, the control unit switches to creep speed

Further LCD screen functions

Further information on the LCD monitor is covered in the following sections:

- Section "Use" > "Control unit" > "Control panel": see Page
- Section "Use" > "Power seat functions": see Page 59
- Section "Maintenance/repair" > "Troubleshooting": see Page 83

6.14.2 Control panel for attendant

If the power wheelchair control panel is mounted behind the seat, the attendant instead of the user can carry out all control functions (see Page 22).

6.14.3 Attendant control

6.14.3.1 VR2 attendant control

The power wheelchair has been equipped with a separate control panel for attendant operation. The separate control panel is height-adjustable and removable.

Functional overview

The attendant uses the attendant control to operate the driving function and the power seat functions. The module is connected in conjunction with the control panel or as a separate input device.

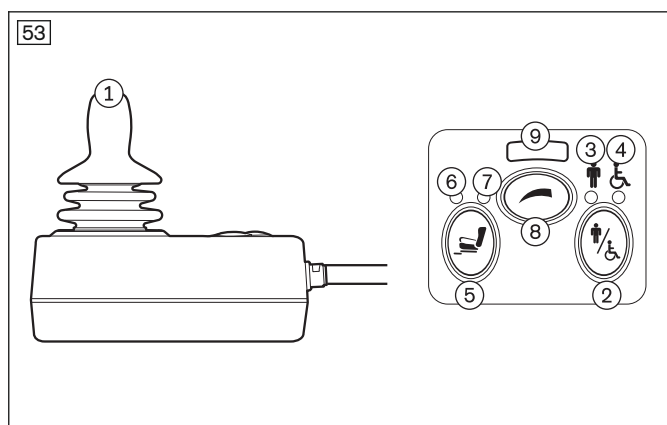

- 1 Joystick
- 2 [Activate/deactivate attendant control] button
- 3 [Attendant control active] LED display (green LED display)
- 4 [Primary control active] LED display (red LED display)
- 5 [Select additional power function] button
- 6 [Seat function 1] LED display
- 7 [Seat function 2] LED display
- 8 [Select speed level] button
- 9 [Selected speed level] LED display

Joystick

The attendant uses the joystick to control the speed and driving direction. When a seat option is activated, the joystick operates this seat option.

[Activate/deactivate attendant control] button

The attendant uses this button to assume the control functions from the control panel or to return them to the control panel. The current state is shown by an LED indicator.

[Attendant control active] LED display

The green LED lights up when the attendant control is activated and the power wheelchair control panel is deactivated.

[Primary control active] LED display

The red LED lights up when the attendant control is deactivated and the power wheelchair control panel is activated.

[Select additional power function] button

Pressing this button selects seat function 1, then seat function 2. The selected seat function is indicated by the LEDs.

Pressing the button one more time returns to driving mode (seat function LED display is not lit).

[Seat function 1/2] LED display

This LED display shows the currently active additional power function.

[Select speed level] button

Pressing the button increases/decreases the speed level. The acoustic signal changes when the maximum speed level is reached.

[Selected speed level] LED display

The LEDs show the currently selected speed level (1-5).

6.14.3.2 R-Net attendant control

The power wheelchair has been equipped with a separate control panel for attendant operation. The separate control panel is height-adjustable and removable.

Functional overview

The attendant uses the attendant control to operate the driving function and the power seat functions.

The module is connected in conjunction with the control panel or as a separate input device.

The module is connected in combination with the separate LCD monitor and special control (if any).

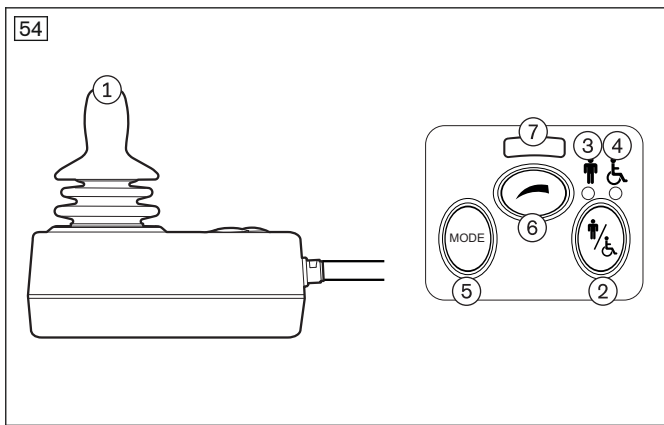

- 1 Joystick
- 2 [Activate/deactivate attendant control] button
- 3 [Attendant control active] LED display (green LED display)
- 4 [Primary control active] LED display (red LED display)
- 5 [Mode] button
- 6 [Select speed level] button
- 7 [Selected speed level] LED display

Joystick

The speed and driving direction are controlled in "Drive" mode with the joystick (see Page 42).

If the control unit is in a seat mode, the seat option can be operated by moving the joystick forwards/backwards (see Page 58) or switched to the next seat option by moving it left/right.

You can navigate within the operating modes (e.g. "Bluetooth") by moving the joystick forwards/backwards or right/left.

[Activate/deactivate attendant control] button

The attendant uses this button to assume the control functions from the control panel or special control (if installed). By pressing the button again, the attendant returns the control functions to the control panel or special control. The respective state is shown by an LED indicator.

After the attendant control has been switched on, the LCD screen on the control panel shows the following information:

Symbol	Information
	Attendant control active

[Attendant control active] LED display

The green LED lights up when the attendant control is activated and the power wheelchair control panel is deactivated.

[Primary control active] LED display

The red LED lights up when the attendant control is deactivated and the power wheelchair control panel is activated.

[Mode] button

Pressing this button toggles through the programmed operating modes ("Power seat functions" > "Bluetooth" >.... > "Drive"). The joystick is used to navigate within the operating modes (see above).

[Select speed level] button

Pressing the button increases/decreases the speed level. The acoustic signal changes when the maximum speed level is reached.

[Selected speed level] LED display

The LEDs show the currently selected speed level (1–5).

6.14.4 Wireless environmental control

NOTICE

Use of devices with electromagnetic emissions

Restriction of function due to electromagnetic fields

- The performance of the product can be affected by electromagnetic fields (highly radiating devices such as amateur radio or superimposed frequencies). If necessary, switch such devices off while using this product.

INFORMATION

Please note: The name of the mode for controlling household devices has been designated "I/O Module 1" at delivery. The name can be individually modified by the qualified personnel prior to handover to the user.

The "I/O Module 1" mode provides the opportunity to control up to 6 household devices (e.g. power outlets, light switches, blinds, etc.) wirelessly via the control panel.

Operating in the background, the EasyWave wireless module is a transmitter (frequency 868.30 MHz), which uses the Easywave protocol especially developed for building services. This protocol is used in numerous building services products available in the market.

The maximum tested range is **20 m**.

The devices being controlled must be synchronised with the control unit prior to use. Synchronisation is performed by the qualified personnel.

Retrieving/exiting "I/O Module 1"

The environmental control mode for devices with infrared remote control is retrieved/exited as follows:

- Repeatedly pressing the [Profile/mode] button retrieves the profiles and operating modes in succession (see Page 26; dependent on programming).
- When "I/O Module 1" mode is reached, the programmed building services devices can be wirelessly controlled (see below).
- Pressing the [Profile/mode] button again allows you to switch to further operating modes and back to the driving profiles again (dependent on programming).

LCD display in "I/O Module 1" mode – TEN° control panel

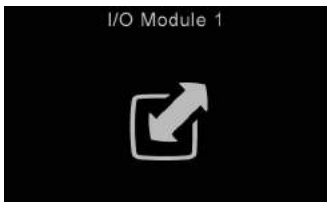
Display	Information
	<p>"I/O Module" mode active</p> <p>The devices being controlled must be synchronised with the control unit prior to use. Synchronisation is performed by the qualified personnel.</p>

Operating devices

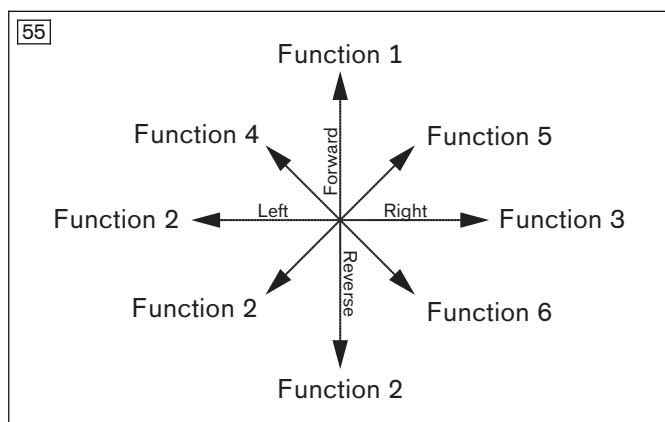

The desired function can be controlled in "I/O Module 1" mode by moving the joystick in the corresponding direction.

Example: Function 1 is started by moving the joystick forwards.

6.14.5 Special controls

Ottobock provides the option to equip the power wheelchair with special controls with various input modules.



Possible input modules

- Micro joystick
- Multi joystick
- All-round joystick
- Sip and puff control
- Chin control with swivel arm (see fig. 56)
- Push-button control
- Piko buttons

Further information can be found in the enclosed instructions for use, "R-Net special controls and environmental control".

6.14.6 Push-button control

The power wheelchair is equipped with a push-button control module.

The push-button control module lets the user select defined functions (e.g. power seat functions) directly during normal driving operation.

6.14.7 Adapter cable for Piko button

- The adapter cable makes it possible to connect Piko buttons for control functions.
- The Piko buttons, which are connected in pairs, are used to control power seat functions as well as other functions (see below). These functions are specified when the power wheelchair is ordered.
- If e.g. the chin control is connected, the chin control moves to the active position when a button is pressed. The chin control moves back to the passive position when the second button is pressed.

Available functions

The following functions can be controlled directly with the Piko buttons:

- Chin control
- Power seat height adjustment
- Power back angle adjustment
- Power seat tilt
- Combined seat height adjustment/seat tilt
- Power legrest left
- Power legrest right

6.14.8 Joystick top



The joystick top enlarges the support surface for the hand, thereby making it easier to operate the input device.

6.15 Additional options

6.15.1 Control panel holder

Swing-away control panel holder

The control panel holder makes it possible to drive the power wheelchair under a table or closer to an object. The control panel holder can be rotated up to the armrest.



Swinging away the control panel holder

- 1) Apply slight pressure to push the control panel holder to the side.
→ The pivot element is unlocked.
- 2) Swing the control panel holder away to the side.
INFORMATION: The pivot element locks in place again when the holder is rotated back to the original position.



Swinging away the control panel holder

- 1) Apply slight pressure to push the control panel holder to the side.
→ The pivot element is unlocked.
- 2) Swing the control panel holder away to the side.
INFORMATION: The pivot element locks in place again when the holder is rotated back to the original position.

6.15.2 Lighting

Information on replacing broken lamps: see Page 82.

6.15.2.1 Lighting for road traffic

The installed lighting permits driving in road traffic during hours of darkness, and is only approved for use on motorised wheelchairs.

The light, the right and left direction indicators and the warning flashers are operated via the control panel.

Front lighting



The front lighting consists of 2 front lights with integrated direction indicators (see fig. 60, left).

To prevent damage while manoeuvring in confined spaces, the front lighting is attached to the wheelchair magnetically.

If the front lighting has been disconnected from the holder, it can simply be reinserted in the prior position (see fig. 60, right).

When connecting the lights, make sure there are no foreign objects on the magnets.

The lighting angle is secured by latches.

Rear lighting



The rear lighting consists of 2 LED rear lights with integrated direction indicators.

6.15.2.2 Lighting (not intended for road traffic)

The installed lighting makes driving on footpaths easier during hours of darkness. Power wheelchairs with this equipment are not permitted for use in road traffic.

The lighting is mounted on the front right side in the driving direction. The lighting angle is secured by latches.

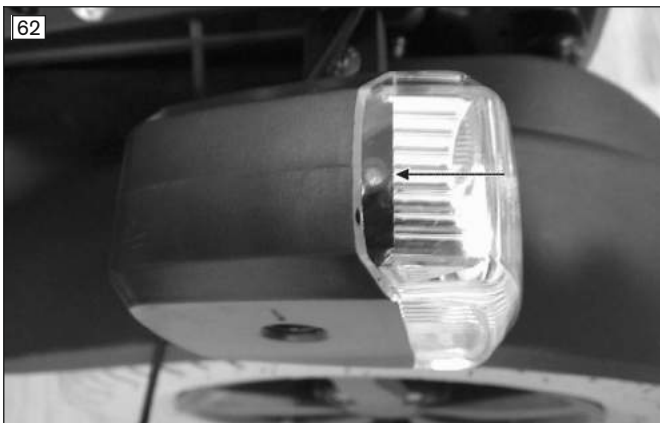

The integrated daylight sensor (see fig. 62, arrow) causes the light to turn on and off automatically depending on the outdoor light level when the control unit is on.

INFORMATION: Clean the daylight sensor regularly so the outdoor light level is detected accurately.

The lamp is attached magnetically. This can be removed for manoeuvring in confined spaces.

If the lamp has been disconnected from the holder, it can be simply reinserted in the prior position.

When connecting the lamps, make sure there are no foreign objects on the magnets.

6.15.3 Belts/belt systems

INFORMATION

Information on the lap belt: see Page 61.

The following instructions for adjustment and use apply to four-way chest straps, upper body straps and vests as well as chest/shoulder straps.

6.15.3.1 Adaptation

⚠ CAUTION

Improper adjustments

Injuries, malpositions, illness of the user due to adjustment changes

- ▶ The belt system is an important part of an individual seating unit/seating solution. Do not modify the installation position and basic settings established by the qualified personnel.
- ▶ In case of problems with these adjustments (such as an unsatisfactory sitting position), promptly contact the qualified personnel who fitted the product.
- ▶ **Immediately** consult the qualified personnel if you detect signs of discomfort or fear when using the product.
- ▶ Have the basic settings of the belt system checked regularly. Adjustments may be required due to the growth of the user or because of changes in the course of the disease.

Small length adjustments of the belt by the user or an attendant (e.g. for clothing of different thickness) are possible.

Positioning the user in the seat

- Place the user in an upright, 90° seated position (if physiologically possible).
- Ensure that the back is up against the backrest padding (if physiologically possible).
- **Applies only to upper body straps/vests, chest/shoulder straps:**
 - Ensure that the height of the backrest on the product is adjusted correctly. The top of the backrest must be at the height of the shoulders.
 - The belt system is intended to support the area of the upper body (breastbone) from the front. The upper and lower straps have to be adjusted as needed.
 - Ensure that the positioning system is not too close to the throat. Otherwise the upper straps have to be readjusted.

Possible positioning errors

- The user's hips are not secured with a separate lap belt (see Page 61).
- If the positioning system is too loose, the user can shift forward/slide down.
- The positioning system collides with devices, accessories or supply hoses during installation and adjustment, restricting their functionality.
- **Applies only to upper body straps/vests, chest/shoulder straps:**
 - The positioning system is too close to the throat, endangering the user.
 - The positioning system makes contact with the user in the area of the soft part of the stomach (too low).

Adjusting the belt length

Notes on correct adjustment are found in the instructions for use included with the belt system.

6.15.3.2 Use

WARNING

Incorrect application

Throttling, suffocation or strangulation due to sliding forward/down in the product

- ▶ The belt system must be used at all times while riding in the product. Always use the belt system in combination with a correctly applied and adapted positioning lap belt to stabilise the pelvis.
- ▶ The belt system has to fit closely but not too tightly so the user is not injured. Sliding two fingers comfortably between the positioning system and upper body should be possible.
- ▶ Ensure that the buckle lies in the middle of the body.
- ▶ Ensure that the belt system is not too close to the throat. Otherwise the upper straps have to be readjusted.
- ▶ Remove any objects or clothing which get caught.

CAUTION

Incorrect application

Risk of pressure points, constriction due to user error

- ▶ **Applies only to upper body straps/vests, chest/shoulder straps:** Follow the positioning instructions. Ensure that the belt system lies against the chest evenly on both sides and is not too tight.
- ▶ **Applies only to upper body straps/vests, chest/shoulder straps:** Ensure that the belt system supports the area of the upper body from the front. The belt system has to be applied/positioned so that the neck and area of the throat remain free at all times.

CAUTION

Improper use

Falls, user falling out due to improper use

- ▶ Only open the belt system and the applied lap belt when the user is ready to get out of the product.
- ▶ Do not leave the user unsupervised if the cognitive abilities of the user could lead to unintentional opening of the belt system.
- ▶ Information about subsequent acquisition and mounting is provided by the qualified personnel that handed the product over to you.

CAUTION**Medical risks**

Injuries, pressure sores due to application errors

- ▶ Regular measures for pressure redistribution and skin examinations are required. Should skin irritation and/or skin reddening occur, consult the qualified personnel who adapted and adjusted the product. Do not continue using the product without consultation.

The belt system can be used for additional positioning of the user in the power wheelchair.

Applying the belt system

Notes on correct application are found in the instructions for use included with the belt system.

Cleaning a belt system with metal buckle**INFORMATION**

Observe the washing recommendations on the product and the information in the corresponding instructions for use provided for the product.

- Belts with metal snaps may **not be washed in washing machines** as the penetration of water could cause corrosion and subsequent malfunctions.
- Clean the belt straps by gently dabbing them with warm soapy water (with some disinfectant) or carefully wiped with a dry, clean, absorbent cloth.

Cleaning a belt system with plastic buckle

- Depending on the model, straps with plastic buckles can be washed in the washing machine between **40 °C** and **60 °C**.
- Recommendation: Use a laundry bag or net and mild detergent.

INFORMATION

Alternatively, the belt straps can be cleaned by gently dabbing them with warm soapy water (with some disinfectant) or carefully wiped with a dry, clean, absorbent cloth.

Additional cleaning instructions

- Allow the belts to air dry. Ensure that the belts and pads are completely dry before installation.
- Do not expose the belts to direct heat (e.g. sunshine, stove or radiator).
- Do not iron or bleach the belts.

6.15.4 Caster wheel swivel lock

The caster wheel swivel lock is used to lock the caster wheels in the forward direction so turning is no longer possible. Having the power wheelchair drive in a perfectly straight line increases safety when driving on ramps or using lifts.

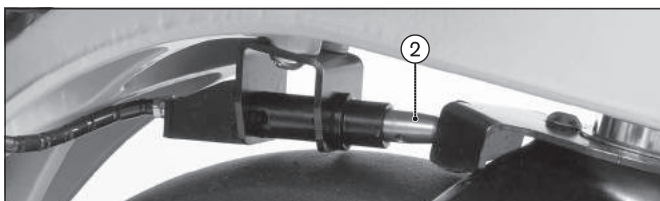
**Engaging the caster wheel swivel lock**

- 1) Push the release lever down (see fig. 63, item 1).
- 2) The caster wheel swivel lock bolt engages in the front fork (see fig. 63, item 2). The power wheelchair drives straight in both forward and reverse.

NOTICE! Please note that the caster wheel swivel lock functions by manual means and has no impact on the joystick functions. Please avoid excessive steering movements on the joystick. This could result in a high mechanical load on the caster wheel swivel lock and thereby to a defect.

INFORMATION: Clean the caster wheel swivel lock bolt if it gets dirty.

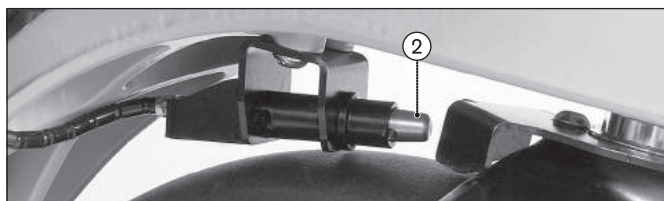

Releasing the caster wheel swivel lock

- 1) Push the release lever up (see fig. 64, item 1).
- 2) The caster wheel swivel lock bolt (see fig. 64, item 2) releases the front fork again. The caster wheels are unlocked and can swivel freely again.

6.15.5 Spring-mounted caster wheel swing arm



The spring elements on the two caster wheel swing arms increase driving comfort especially when driving on rough terrain.

They also improve traction.

6.15.6 Mechanical track stabiliser



The mechanical track stabiliser (see fig. 66, item 1) under the caster wheel swing arm stabilises the caster wheels when moving forward at high speeds.

As a result, the track is better maintained when driving straight forwards (e.g. in road traffic).

6.15.7 Electronic track stabiliser

INFORMATION

As the electronic track stabiliser feature is disrupted by the movement of public means of transportation (bus; train; ship), the user must activate the "No assist" driving profile prior to driving in public means of transportation for safety reasons (see Page 26). The electronic track stabiliser is switched off in this driving profile.

A gyro module is integrated into the R-Net control system.

The gyro module combines signals from a joystick with positional and directional information provided by a gyroscope.

The system can thereby detect whether the power wheelchair is deviating from the specified straight line and automatically correct the driving path.

6.15.8 Luggage carrier

NOTICE

Overloading the luggage carrier

Damage to product due to breakage

- ▶ The maximum load capacity for the luggage carrier is **15 kg (33 lbs)**.

The luggage carrier can be used to mount add-on medical devices or to store luggage. The luggage carrier can be removed if required.

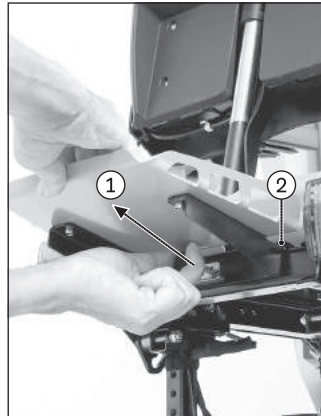
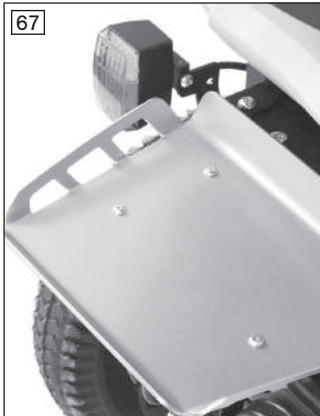

Removing the luggage carrier

- 1) Pull out the release bolt under the tray (see fig. 67, item 1).
- 2) Slightly lift the luggage carrier and take it off the support bar (see fig. 67, item 2).

Putting on the luggage carrier

- 1) Slightly lift the luggage carrier and set it onto the support bar (see fig. 67, item 2).
- 2) Push the luggage carrier down until the release bolt (see fig. 67, item 1) engages.

6.15.9 Curb climbing assist

The curb climbing assist makes it possible to overcome curbs and steps with a maximum height of **100 mm (4")**.

INFORMATION: Deviating values for other wheel combinations, see the section "Technical data".



Using the curb climbing assist

- > The curb climbing assist must protrude to the front when driving outdoors.
- 1) Drive against an obstacle (e.g. a high curb).
 - 2) The curb climbing assist lifts the power wheelchair over the obstacle.
 - 3) After crossing the obstacle, the curb climbing assist returns to the active, forward-facing position.

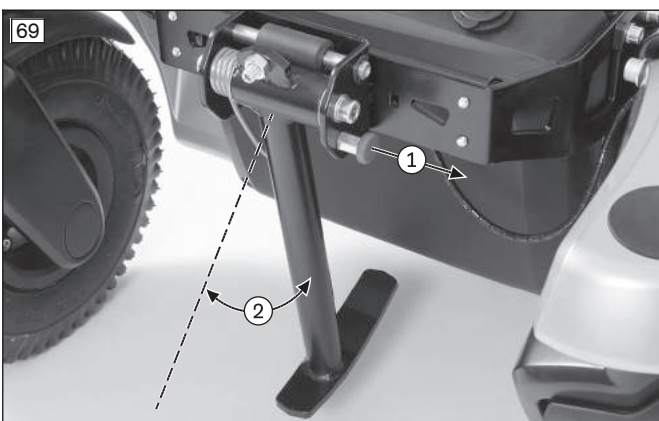

Temporarily deactivating the curb climbing assist

- > The curb climbing assist can be deactivated when driving indoors.
- 1) Pull the release button (see fig. 69, item 1).
 - 2) Swing the curb climbing assist back until the locking mechanism engages (see fig. 69, item 2).
 - 3) The curb climbing assist is deactivated.

6.15.10 External power supply

NOTICE

Overloading the connections

Power supply defect

- ▶ Avoid using all connections at full capacity at the same time.
- ▶ For example, if you are charging an oxygen unit on the 12 V connection, you should not charge a tablet PC on the USB connection at the same time.

The external power supply is used to charge or operate external devices such as mobile phones, laptops or oxygen units.

The type of power supply is embossed in the cover cap. The sides can be chosen as desired.



Possible connections:

USB: The connection can be used to charge or operate devices with a standard USB battery charger (see fig. 70, item 1). Outputs: 5 V; to 1 A; 5 V to 2.1 A.

12 V: The connection can be used to charge or operate devices with a 12 V motor vehicle power adapter ("Cigarette lighter plug"; see fig. 70, item 2). Output: up to 5 A. Power output: maximum 60 W.

24 V: The connection can be used to charge or operate devices with a 24 V motor vehicle power adapter (not illustrated). Output: up to 3 A. Power output: maximum 72 W.

6.15.11 Hand heater

The hand heater with a cover for one or two hands is an option for installation on Ottobock power wheelchairs.

The product produces a stream of warm air that increases the temperature in the area of the control panel under cold ambient conditions.

Detailed information regarding use, cleaning and maintenance can be found in the included instructions for use.

6.15.12 Overview of other options

INFORMATION

You can find these and other optional add-on components on the order form and in the accessories catalogue.

The power wheelchair is equipped with additional options:

- Splash guard for drive wheels
- Splash guard for caster wheels
- Joystick top: Tetra fork, STICK S80, softball, ball top, sponge ball
- Crutch holder
- Folding rearview mirror
- Rear marker plate
- Tray
- External horn
- Pocket for mobile phone
- Beverage holder
- Tool kit
- Airman pump

6.16 Disassembly and transport

6.16.1 Safety instructions

⚠ WARNING

Improper transportation in aircraft

Burns, explosion or damage to the battery due to failure to observe the rules for transportation

- ▶ Follow the rules of the IATA (International Air Transport Association) and the respective airline when transporting the power wheelchair in an aircraft. Before checking in the power wheelchair, the automatic circuit breaker has to be deactivated and the battery connectors must be insulated so they cannot short-circuit.
- ▶ Note that those batteries in particular which may leak or will not be transported upright must be removed and packaged so they cannot leak or short circuit.
- ▶ For more information please visit the www.iata.org website. The manufacturer recommends contacting the airline directly before every flight to obtain information regarding special transport regulations.
- ▶ Use the SSR (special service request) codes to describe the type of limited mobility if necessary. You can for example research these on the Internet.

⚠ CAUTION

Securing the power wheelchair insufficiently during transport

Crushing, pinching of body parts due to failure to observe transportation instructions

- ▶ During transportation in vehicles or aircraft, on lifting platforms or in lifts, turn the control unit of the power wheelchair off and lock the brake.
- ▶ The power wheelchair must be secured in accordance with the regulations for the transport device.
- ▶ During transport in a vehicle, the power wheelchair must be secured sufficiently with cargo straps. Only attach the cargo straps to the corresponding transportation eyelets and specified tie-down points.

NOTICE

Lifting the power wheelchair incorrectly

Damage to the power wheelchair due to failure to observe transportation instructions

- ▶ Hoisting devices used for transportation must have a sufficient capacity. For more information about weight, see the section "Technical data" (see Page 89).
- ▶ Do **not** attach the hoisting devices on moveable or adjustable components.
- ▶ Ensure that the seat is lowered all the way and the backrest is in a vertical position prior to loading and for transporting the power wheelchair.

6.16.2 Reducing the transportation size

The transportation size can be reduced in a few steps to make transporting the product easier.

71



Preparing for transport

- 1) Fold the backrest forward and onto the seat surface (see Page 20).
- 2) Remove the side panels (see Page 16). Place the side panel on the seat.
- 3) Remove the legrests (see Page 19).

72



Preparing for transport

- 1) Fold the backrest forward and onto the seat surface (see Page 20).
- 2) Remove the side panels (see Page 16). Place the side panel with control panel on the seat.
- 3) Remove the legrests (see Page 19).

6.16.3 Preparing for transport

73

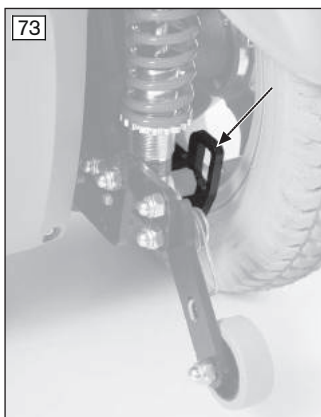

Transporting the power wheelchair

- 1) Position the power wheelchair in its transport location.
- 2) Turn the control unit off (see Page 22 ff.).
- 3) Verify brake locking. It should not be possible to push the power wheelchair.
If needed: Lock the brake (see Page 45).
- 4) Use the eyebolts and cargo straps to attach the power wheelchair to the transport vehicle (see arrows).

6.17 Use in vehicles for transporting persons with reduced mobility

⚠ WARNING

Use in vehicles for transporting persons with reduced mobility

Serious injuries in case of accidents due to user error

- ▶ Always use the seats and restraint systems in the vehicle for transporting persons with reduced mobility first. This is the only way to ensure optimum protection of passengers in the event of an accident.
- ▶ If the product is to be used as a seat in a vehicle for transporting persons with reduced mobility, the safety elements offered by the manufacturer and appropriate personal restraint systems must be used. For more information, please refer to our brochure with the order number 646D158.
- ▶ Never transport more than one person in the power wheelchair.
- ▶ Turn off the control unit after positioning the power wheelchair in the vehicle for transporting persons with reduced mobility.
- ▶ Use the power wheelchair in a vehicle for transporting persons with reduced mobility only if the seat is all the way down and the backrest is in a vertical position.
- ▶ Observe the limitations regarding installed options (see Page 79).

⚠ WARNING

Use of the belt system as a passenger restraint system in vehicles for transporting persons with reduced mobility is forbidden

Serious injuries due to improper handling of the product

- ▶ Under no circumstances may the belts and positioning aids offered with the product be used as part of a passenger restraint system in vehicles for transporting persons with reduced mobility.
- ▶ Note that the belts and positioning aids offered with the product are only intended to help support the user sitting in the product.

The product may be used as a seat in vehicles for transporting persons with reduced mobility.

During transport in vehicles for transporting persons with reduced mobility, the product must be sufficiently secured with attachment straps.

6.17.1 Required accessories

To use the power wheelchair as a seat in a vehicle for transporting persons with reduced mobility, additional options have to be mounted (491S00=* anchor point kit). The qualified personnel who fitted the wheelchair can provide more information.

Using the product in the vehicle

⚠ WARNING

Positioning in vehicles for transporting persons with reduced mobility

Serious injuries in case of accidents due to user error

- ▶ Positioning in vehicles for transporting persons with reduced mobility may only be performed by qualified personnel.
- ▶ Instruct the qualified personnel regarding the mounting points on your product described below.

The product has been tested according to ANSI/RESNA and ISO 7176-19.

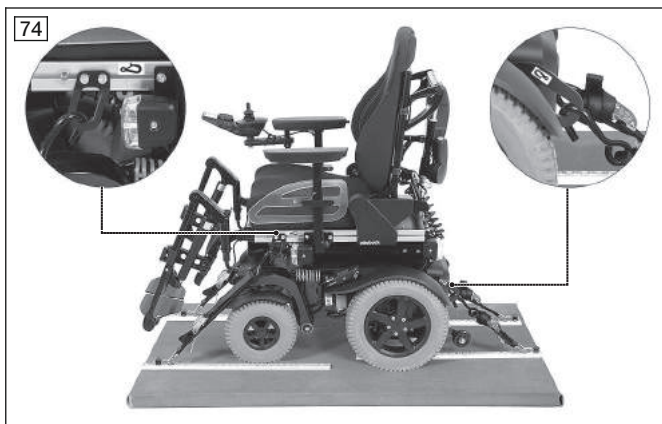

Securing the power wheelchair in the vehicle

- 1) Position the power wheelchair in the vehicle for transporting persons with reduced mobility. For more information, refer to section 5 in the brochure "Transporting persons with reduced mobility", order number 646D158.
- 2) Turn the control unit off (see Page 41).
- 3) Verify brake locking. Engage the brakes if needed (see Page 45).
- 4) Apply the attachment straps (see below).

Applying the attachment straps

- 1) Hook each of the front attachment straps into its corresponding front anchor point from the outside (see fig. 74, left).
- 2) Hook each of the rear attachment straps into its corresponding rear anchor point from the outside (see fig. 74, right).
- 3) Tighten the front and rear attachment straps.

Placement of the restraint lap belt

Fastening the restraint lap belt of the vehicle for transporting persons with reduced mobility is mandatory. The belt system of the power wheelchair can be used in addition to position the passenger during transportation.



Fastening the restraint lap belt

- 1) Thread each end of the lap restraint belt from the seat side between the seat bottom and side panel to the outside.
- 2) Hook the end of the restraint lap belt onto the pin (see arrow).



Fastening the restraint lap belt

- 1) Thread each end of the lap restraint belt from the seat side between the seat bottom and side panel to the outside.
- 2) Hook the end of the restraint lap belt onto the pin (see fig. 76, see arrow).

Restrictions for use

⚠ WARNING

Risk of accidents and injury due to using the product with certain settings and/or installed options

Severe injury in case of accidents due to options coming loose

- ▶ Before using the product as a seat in a vehicle for transporting persons with reduced mobility, remove options that need to be taken off for safe transportation. Please observe the following table.
- ▶ Stow all dismantled components securely in the vehicle for transporting persons with reduced mobility.
- ▶ Please note that certain settings on the product exclude the use of the product in a vehicle for transporting persons with reduced mobility.

Options*	Transportation in a vehicle for transporting persons with reduced mobility not possible	Option must be removed	Secure option on product
Headrest with mounting kit		X	
Folding rearview mirror		X	
Tray, swing-away to the side		X	
Lap belt with buckle			X**
Four-way chest strap kit, static			X**
Luggage carrier for respirator			X
Control panel holder, swing-away in parallel			X
Height-adjustable control panel holder, swing-away			X

* The following list provides an overview. Not all options are installed on all products.

** The belt can be used to position the passenger during transportation. Using the passenger restraint system is nevertheless required.

Special control (version*)	Transportation in a vehicle for transporting persons with reduced mobility not possible	Option must be removed	Secure option on product
Sip and puff control (standard control panel included)			X
Chin control with mini joystick, power swing-away			X
Chin control with midi joystick, power swing-away			X

* The following list provides an overview of all versions of the special control that cannot be used.

6.17.2 Prohibited use

⚠ WARNING

Improper use in vehicles for transporting persons with reduced mobility

Risk of serious injury when using the product as a seat

- ▶ Please note that certain optional components on the product exclude the use of the product in a vehicle for transporting persons with reduced mobility.
- ▶ The product has **not** been approved by the manufacturer for use as a seat in vehicles for transporting persons with reduced mobility in combination with a **Recaro seat**. Please refer to the prohibition symbol on the nameplate (see below).
- ▶ In vehicles for transporting persons with reduced mobility, only use the seats installed in the vehicle with the corresponding personal restraint systems.
- ▶ Information on the current status of our measures is available from your specialist dealer.

6.18 Care

6.18.1 Safety instructions

NOTICE

Incorrect cleaning

Damage to the product through user error

- ▶ Water must not come into direct contact with the electronics, motor or battery under any circumstances.
- ▶ Never use a water jet or high-pressure cleaning apparatus to clean the product.
- ▶ Use a cloth or sponge for cleaning.
- ▶ To avoid corrosion, do not use any aggressive cleaning agents or solvents.
- ▶ Check the driving behaviour of the product after cleaning it.

INFORMATION

Piston rods do not require lubrication. They are maintenance-free.

6.18.2 Cleaning

The power wheelchair must be cleaned regularly, depending on the amount of use and the degree of soiling.

- Clean the control panel, battery charger, armrest and trim components with a damp cloth and mild cleaning solution.
- Use a dry brush to clean the seat and back upholstery as well as the seat cushion.
- Use a damp plastic brush to clean the wheels and frame.
- Do not use any aggressive cleaners, solvents or hard brushes etc.
- Do not spray the product with a pressure washer.

6.18.3 Disinfection

- 1) Thoroughly clean the pads before disinfecting.
- 2) Wipe all parts of the product with a disinfectant.

Important information about disinfecting

- Only use colourless water-based disinfectants. Observe the instructions for use provided by the manufacturer.
- Prior to disinfection, clean the seat and back padding, control panel and armrests.

7 Maintenance and repair

7.1 Safety instructions

⚠ WARNING

Insufficient maintenance

Severe user injuries, damage to the product due to failure to observe maintenance intervals

- ▶ The power wheelchair may only be serviced by qualified personnel trained by the manufacturer. The functionality and operating safety of the power wheelchair must be verified and a service performed at least **1 x per year**.
- ▶ In case of frequent user changes (children and growing youth) or changing clinical pictures, the power wheelchair should be inspected, adjusted and serviced **1 x every six months**.

⚠ WARNING

Failure to inspect important product features

Severe user injuries, damage to the product due to maintenance errors

- ▶ Inspect the seat adjustment features for visible signs of damage at least **1 x per month** and ensure all screw connections are tight.
- ▶ Maintain sufficient air pressure in the tyres. The correct tyre pressure is printed on the tyre casing and listed in the section "Technical data".

⚠ CAUTION

Uncontrolled driving behaviour, unexpected sounds or odours

Falling, tipping, collision with persons or nearby objects due to defects

- ▶ If any faults, defects or other hazards that can lead to personal injury are detected, the product must be taken out of service immediately. This includes uncontrolled movements as well as sounds that are unexpected or previously not noted or odours that deviate significantly from the state of the product at the time of delivery.
- ▶ Please contact your authorised dealer.

7.2 Maintenance

- The function of the product should be checked before each use.
- The product should not be used if defects are noted. This applies in particular in case of instability of the product or altered driving characteristics as well as problems with the user's seating position or the stability of the seat. Inform the qualified personnel promptly for the rectification of defects.
- This also applies if loose, worn, bent or damaged components, cracks in the frame or broken frame components are identified.
- Some maintenance tasks and smaller repairs can be carried out to a certain extent by the user at home. Further information is found in the sections "Maintenance intervals" (see Page 81) and "Repair" (see Page 82).
- Failure to maintain the product can lead to serious or life-threatening injury to the user of the product.
- Service and repairs may only be carried out by authorised, qualified personnel or the manufacturer. This will ensure that only Ottobock spare parts are used for repairs.

7.2.1 Maintenance intervals

The functions described below must be checked by the user or an attendant at the specified intervals:

Component	Activity	Prior to every use	Weekly	Monthly
Drive wheels	Check whether wheel mounts are securely fastened			X
	Check whether wheels rotate freely and without axial runout			X
	Check directional stability of the power wheelchair	X		
Caster wheels	Check that the fork is seated in the adapter without play			X
	Check whether wheels rotate freely and without axial runout			X
	Check that the mounting nuts are tight			X
Seat attachment	Check that mounting screws are fastened properly			X
	Check that seat lock is positioned securely	X		

Component	Activity	Prior to every use	Weekly	Monthly
Legrest	Check ratchet mechanism for functionality and firm fit			X
	Check for damage to footrests			X
Padding / belts	Ensure padding is in perfect condition			X
	Check the attachment straps for wear			X
	Check belt buckle for functionality		X	
Tyres	Check air pressure (see tyre sidewall)			X
	Check for sufficient tread depth (min. 1 mm/0.04")			X
	Check for damage			X
Batteries	Check battery charge level	X		
Lighting	Check for external damage		X	
	Verify functionality	X		
Electronics	Check that the control unit is functioning properly (inform qualified personnel of any error messages on the control panel)	X		
	Check that the battery charger is functioning properly (inform qualified personnel of any LED error messages)		X	
	Check plug connections			X
Wheel lock	When wheel lock is disengaged: check whether the indicator on the control panel is flashing	X		
	When wheel lock is engaged: check braking function by trying to push the chair			X
Seat adjustment functions	Visually inspect all moving components and cabling for damage			X
	Check that screw connections are tight			X
Side panel and armrest	Check that mounting screws are fastened properly			X
	Check that screw connections between the armrest and the control unit are tight	X		
	Check armrest for damage		X	
Gas compression spring or actuator	Visual inspection for scratches and oil leaks on the piston rod			X

7.3 Repair

⚠ WARNING

Prohibited repairs

Severe user injuries, damage to the product due to adjustment and installation errors

- ▶ Only carry out the repairs described in this section.
- ▶ Other repairs may not be completed by the product user but only by instructed, qualified personnel.

7.3.1 Replacing a defective bulb

NOTICE

Use of incorrect bulbs

Damage/melting of the connecting cables due to excess current flow

- ▶ Note that the LED lighting may only be replaced with original lighting.

The LED lighting is maintenance-free. If repairs are required, the qualified personnel who fitted or delivered the wheelchair can help.

7.3.2 Replacing a battery

Batteries may only be replaced by authorised personnel.

7.4 Troubleshooting

INFORMATION

In the event of communication problems in the bus system of the controls, the system triggers an emergency stop and thus prevents any uncontrolled functions.

- ▶ Note that after every emergency stop, you have to turn the power wheelchair control unit on again.
- ▶ If the driving function is still not available after turning the control unit on again, activate pushing mode by releasing the brake.
- ▶ Inform the qualified personnel immediately.

7.4.1 Types of notifications

Warning

A warning indicates a status or malfunction of one or several components of the power wheelchair. The function of components without errors is not restricted.

For example, if the connection between the control unit and seat motor is faulty, this error will only be indicated if the user attempts to activate the motor. However, the driving function is still available.

Error

An error affects one or several functions of the power wheelchair. The power wheelchair and its functions are not fully operational until the fault is resolved.

Structure of an error message

The control unit display shows both errors in the control system itself as well as errors in electrical components of the power wheelchair or errors in the cabling. The error message contains the following information:







- Affected module – e.g. JSM = joystick module (control panel); PM = power module (control unit)
- Error code (4 characters)
- Abbreviated error description

7.4.2 Procedure for warnings and error messages

- If a warning or error message appears, the power wheelchair can often no longer be driven. In this case, the error message must be noted, the control unit switched off and the qualified personnel informed of the error message immediately.
- If the error is related to a component which is not currently being used (e.g. to an actuator for adjusting the seat function), the driving function of the power wheelchair is still theoretically usable. An error message simply appears at regular intervals.
- Nonetheless, the control unit **must** be switched off for several minutes in this case. If the error message continues to appear after switching on the control unit, the error message **must** be noted, the control unit switched off again and the qualified personnel informed of the error message immediately.

7.4.3 Wheelchair control unit error overview

VR2 control panel

Flashing LED	Error/warning	Cause	Possible corrective action
	Battery undervoltage	Battery deep discharge Battery cable malfunctioning or faulty connection to the battery	Charge as soon as possible Check the connection to the battery (charge the battery if the connection is good)
	Left motor not connected	e.g. defective plug connection, cable break	Check plug connections and cable to left motor
	Wiring fault on the left motor	e.g. cable break, no connection to battery	Check cable connections to left motor; check connection to battery terminal
	Right motor not connected	e.g. defective plug connection, cable break	Check plug connections and cable to right motor
	Defective cables on right motor	e.g. cable break, no connection to battery	Check cable connections to right motor; check connection to battery terminal
	Driving function blocked due to external factors	Battery charger may be connected	Disconnect battery charger

Flashing LED	Error/warning	Cause	Possible corrective action
	Joystick fault	Joystick not in home position when the unit is turned on	Move the joystick to the home position before switching the unit on
	Controller fault	Defective controller	Check all connections
	Brake release	Open brake release	Check motor brakes Check connection to the controller
	Battery overvoltage	Voltage too high Loose battery contacts	Continue driving slowly Check cabling/plug contacts
	Communication error between control panel (joystick) and controller	Defective cable, loose plug connection	Check cabling/plug contacts

TEN° control panel

Symbol	Error/warning	Cause	Possible measure
	Emergency stop	Severe controller / handheld control unit and/or drive motor malfunction	Check cabling / plug connections Contact specialist dealer
	Joystick warning (Center Joystick)	Joystick not in home position when the unit is turned on	Move the joystick to the home position before switching the unit on
	Defective joystick (Joystick Error)	Message continues to be displayed despite moving joystick to centre position	Contact specialist dealer
	Message window for serious errors	Causes of the respective error messages: see following table	Measures for the respective error messages: see following table
	Message window for warnings (Error message examples: see next 2 lines)	Causes of the respective warning messages: see following table	Measures for the respective warning messages: see following table
	Controller temperature warning (lights up red)	Overheating due to excessive load	Cool down phase
	Motor temperature warning (lights up red)	Overheating due to excessive load	Cool down phase

Error and warning messages on the TEN° control panel

Error message	Error no.	Content	Cause	Possible measure
Center Joystick		See previous table		
Joystick Error		See previous table		
Low Battery	(None)	Battery undervoltage	Battery deep discharge	Charge as soon as possible
High Battery	(None)	Battery overvoltage	Voltage too high	Continue driving slowly





Error message	Error no.	Content	Cause	Possible measure
			Loose battery contacts	Check cabling / plug connections; if error message persists, contact specialist dealer
M1 Brake Error	1505	Brake error on left motor	e.g. defective plug connection, cable break Defective brake	Check plug connections and cable to brake If error persists: contact specialist dealer
M2 Brake Error	1506	Brake error on right motor		
M1 Motor Error	3B00	Left motor not connected	e.g. defective plug connection, cable break	Check plug connections and cable to motor
M2 Motor Error	3C00	Right motor not connected		
Inhibit Active	1E01; 1E20; 1E21; 1E22; 1E23	Driving function blocked due to external factors	Battery charger may be connected	Disconnect battery charger
Brake Lamp Short	(None)	Short circuit in brake light electrical circuit	e.g. defective plug connection, cable break Defective brake light	Check plug connections and cable to brake light If error persists: contact specialist dealer
Left Lamp Short	7205	Short circuit in electrical circuit of left front/rear light	e.g. defective plug connection, cable break	Check plug connections and cable to front/rear light
Right Lamp Short	7209	Short circuit in electrical circuit of right front/rear light	Defective front/rear light	If error persists: contact specialist dealer
L Ind Lamp Short	7206	Short circuit in electrical circuit of left direction indicator	e.g. defective plug connection, cable break	Check plug connections and cable to direction indicator
R Ind Lamp Short	720A	Short circuit in electrical circuit of right direction indicator	Defective direction indicator signal	If error persists: contact specialist dealer
L Ind Lamp Failed	7207	Error in electrical circuit of left direction indicator	e.g. defective plug connection, cable break	Check plug connections and cable to direction indicator
R Ind Lamp Failed	7208	Error in electrical circuit of right direction indicator	Defective bulb	If error persists: contact specialist dealer
Over-current	(None)	Amount of current in an actuator circuit too great	e.g. defective plug connection, cable break Defective servomotor (actuator) or controller	Check plug connections and cable to servomotor; verify that actuating drive can move freely If error persists: contact specialist dealer
Overtemp. (Acts)	(None)	Temperature on actuator circuits on controller too high	e.g. defective plug connections Defective servomotor (actuator)	Cool down phase Check plug connections and cable to actuator In case of recurrence: contact specialist dealer
Overtemp. (Lamps)	(None)		e.g. defective plug connections	Cool down phase

Error message	Error no.	Content	Cause	Possible measure
		Temperature on the light circuit on the controller too high	Defective lamp	Check plug connections and cable to light In case of recurrence: contact specialist dealer
Memory Error	(None)	Unspecified memory error in control modules	e.g. defective plug connection, cable break Defective control module	Contact specialist dealer
PM Memory Error	(None)	Memory error in controller	e.g. defective plug connection, cable break Defective controller	Check all plug connections and cables on controller If error persists: contact specialist dealer
Bad Cable	(None)	Error on the communication cables between control modules	e.g. defective plug connection, cable break	Check all plug connections and cables on the control modules (incl. controller) If error persists: contact specialist dealer
Module Error	(None)	Error in control modules	e.g. unspecified error in displayed control module Displayed control module defective	Check all plug connections and cables If error persists: contact specialist dealer
System Error	(None)	System error	Non-attributable error in control modules (primarily from third-party providers)	Check all plug connections and cables; disconnect/test any modules from third-party providers in succession if applicable If error persists: contact specialist dealer
SID Detached	(None)	Special control disconnected	Special control disconnected from LCD monitor (sip and puff control) Special control connection to LCD monitor defective	Check all plug connections and cables between special control connection and sip and puff control; check programming parameters If error persists: contact specialist dealer
Switch Detached	1E07	External on/off switch disconnected from control panel	e.g. defective cable connection to control panel	Check cable connection and switching function of the external switch If error persists: contact specialist dealer
	1E08	External profile/mode switch disconnected from control panel	Defective switch or control panel	
Gone to Sleep	(None)	Control unit switches to sleep mode	Extended inactivity while control unit is switched on	Switch control unit off/on
Charging	(None)	Battery charger is connected	Battery charger is connected to charging receptacle	Disconnect battery charger prior to driving



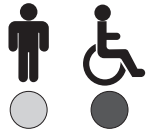

Error message	Error no.	Content	Cause	Possible measure
JS Static Timeout	(None)	Joystick holding time exceeded	Excessive joystick deflection detected (control unit stops drive system to prevent potential damage to the motors) Defective joystick	Switch control unit off/on If error persists: replace control panel / joystick; contact specialist dealer
Orientation Error	(None)	Orientation error on advanced stability module (ASM)	Defective advanced stability module (ASM)	Contact specialist dealer
ASM Disconnected	(None)	Advanced stability module (ASM) disconnected from controller	e.g. defective plug connection, cable break Defective advanced stability module (ASM)	Contact specialist dealer
Gyro Disconnected	(None)	Electronic track stabiliser (gyro module) disconnected from controller	e.g. defective cable connection to controller Defective gyro module	Contact specialist dealer
Gyro Prf Active	(None)	Electronic track stabiliser (gyro module) is activated	Electronic track stabiliser (gyro module) is disrupted by the movement of a different means of transportation (e.g. train, ship) in standby Defective gyro module	When driving/standing in means of transportation, select the "No Assist" driving profile for safety reasons If error persists: contact specialist dealer
Switch Short	1E0D	Short circuit on external on/off switch	e.g. defective cable connection to control panel Defective switch or control panel	Check cable connection and switching function of the external switch If error persists: contact specialist dealer
	1E0C	Short circuit on external profile/mode switch		

7.4.4 Attendant control error overview

VR2 attendant control

Flashing LED	Error/warning	Cause	Possible measure
	Control unit fault	Fault in the control unit	Read error on the control panel and take corresponding action (see "Wheelchair control unit error overview" table)
	Attendant control fault	Defective attendant control	Switch off attendant control and turn control panel off/on
	Joystick error	Attendant control joystick not in home position when the unit is turned on	Switch off attendant control and move joystick to home position before switching the unit on Switch control panel off/on
	Communication error between the attendant control (joystick) and the control panel/controller	Defective cable, loose plug connection	Check cabling / plug connections

R-Net attendant control

Flashing LED	Error/warning	Cause	Possible measure
	Control unit fault	Fault in the control unit	Read error on the control panel and take corresponding action (see "Wheelchair control unit error overview" table)
	Attendant control fault	Defective attendant control	Switch off attendant control and turn control panel off/on
	Joystick error	Attendant control joystick not in home position when the unit is turned on	Switch off attendant control and move joystick to home position before switching the unit on Switch control panel off/on
	Communication error between the attendant control (joystick) and the control panel/controller	Defective cable, loose plug connection	Check cabling / plug connections

8 Disposal

8.1 Safety instructions

NOTICE

Disposal of batteries
 Pollution due to incorrect disposal

- ▶ Observe the information printed on the batteries by the manufacturer.
- ▶ Note that the batteries may not be disposed of as household waste.

8.2 Disposal Information

Return the product to the specialist dealer for disposal.

Please return defective batteries to your specialist dealer when buying new ones.

All components of the product must be disposed of properly in accordance with the respective national environmental regulations.

9 Legal information

All legal conditions are subject to the respective national laws of the country of use and may vary accordingly.

9.1 Liability

The manufacturer will only assume liability if the product is used in accordance with the descriptions and instructions provided in this document. The manufacturer will not assume liability for damage caused by disregard of this document, particularly due to improper use or unauthorised modification of the product.

9.2 CE Conformity

This product meets the requirements of the European Directive 93/42/EEC for medical devices. This product has been classified as a class I device according to the classification criteria outlined in Annex IX of the directive. The declaration of conformity was therefore created by the manufacturer with sole responsibility according to Annex VII of the directive.

The product meets the requirements under the RoHS Directive 2011/65/EU of the European Parliament and of the Council of 8 June 2011 on the restriction of the use of certain hazardous substances in electrical and electronic equipment.

9.3 Warranty

Further information on the warranty terms and conditions can be obtained from the qualified personnel that has fitted this product or the manufacturer's service (see inside back cover for addresses).

9.4 Service Life

Expected service life: **5 years.**

The design, manufacturing and requirements for the intended use of the product are based on the expected service life. These also include the requirements for maintenance, ensuring effectiveness and the safety of the product.

Using the product beyond the specified expected service life leads to increased residual risk and should only take place subject to the due diligence and deliberations of qualified personnel.

If the service life is reached, the user or a responsible attendant should contact the qualified personnel who fitted the product or the manufacturer's servicing department (see inside rear cover or back page for address). Here the user can obtain information about known risks and the current options for refurbishing the product.

10 Technical data

INFORMATION
<ul style="list-style-type: none"> ▶ Much of the technical data below is given in mm. Please note that product settings – unless otherwise specified – cannot be adjusted in the mm range but only in increments of approx. 0.5 cm or 1 cm. ▶ Note that the values achieved during adjustment may deviate from the values specified below. The deviation can be ±10 mm and ±2°.

Application class (according to DIN EN 12184)
Class A

Application class (according to DIN EN 12184)
Class B

Drive type
Front-wheel drive

Drive type
Rear-wheel drive

Mobility base
Size 1

Mobility base
Size 2

Weight (minimum/maximum)	
Front-wheel drive	Minimum: 100 kg (220 lbs) Maximum: 200 kg (441 lbs)
Rear-wheel drive	Minimum: 100 kg (220 lbs) Maximum: 200 kg (441 lbs)

Weight*	
Equipped with mobility base 1 + standard seat	from 110 kg (from 242.5 lbs)
Equipped with mobility base 2 + standard seat	from 125 kg (from 275.5 lbs)
Equipped with mobility base 1 + VAS seat	from 115 kg (from 253.5 lbs)
Equipped with mobility base 2 + VAS seat	from 130 kg (from 286.5 lbs)

* The specified weights vary according to the accessories and selected model.

Load capacity	
Maximum load capacity (User weight + luggage)	up to 140 kg (up to 308.6 lbs)

Please note: When the power wheelchair is equipped with a standard seat, Junior, the maximum load capacity is reduced to 75 kg (user weight + luggage).

Load capacity	
Maximum load capacity (User weight + luggage)	up to 160 kg (up to 352.7 lbs)

Dimensions – standard seat Junior	
--	--

Dimensions – standard seat Junior	
Effective seat depth*	340–400 mm (13.4"–15.7")
Effective seat width*	340–400 mm (13.4"–15.7")
Anterior seat height*	410–570 mm (16.1"–22.4")
Lower leg length**	150–540 mm (5.9"–21.2")
Back height	370/420/470 mm (14.6"/16.5"/18.5")

* In increments of 20 mm

** In increments of 10 mm

Dimensions – standard seat, small	
Effective seat depth*	380–460 mm (15"–18.1")
Effective seat width*	380–420 mm (15"–16.5")
Anterior seat height*	410–570 mm (16.1"–22.4")
Lower leg length**	150–540 mm (5.9"–21.2")
Back height	450/500/550 mm (17.7"/19.7"/21.6")

* In increments of 20 mm

** In increments of 10 mm

Dimensions – standard seat, large	
Effective seat depth*	420–500 mm (16.5"–19.7")
Effective seat width*	440–480 mm (16.9"–18.9")
Anterior seat height*	410–570 mm (16.1"–22.4")
Lower leg length**	150–540 mm (5.9"–21.2")
Back height	450/500/550 mm (17.7"/19.7"/21.6")

* In increments of 20 mm

** In increments of 10 mm

Dimensions – standard seat, XL	
Effective seat depth*	420–500 mm (16.5"–19.7")
Effective seat width*	500–560 mm (19.7"–22")
Anterior seat height*	410–570 mm (16.1"–22.4")
Lower leg length**	150–540 mm (5.9"–21.2")
Back height	450/500/550 mm (17.7"/19.7"/21.6")

* In increments of 20 mm

** In increments of 10 mm

Dimensions – VAS seat (all types)	
Effective seat depth*	380–580 mm (14.6"–22.8")
Effective seat width*	380–540 mm (15"–21.3")
Anterior seat height**	430–570 mm (16.9"–22.4")
Lower leg length***	150–540 mm (5.9"–21.3")
Back height	450/500/550 mm (17.7"/19.7"/21.6")

* Continuous

** In increments of 20 mm

*** In increments of 10 mm

Dimensions – Recaro® seat	
Effective seat depth	380–560 mm (15"–22.8")
Seat width*	Inside: 320–340 mm (12.6"–13.4") Outside: 450–480 mm (17.7"–18.9")
Seat height**	410–570 mm (16.1"–22.4")
Lower leg length	280–540 mm (11"–21.2")
Back height	620 mm (24.4")

* Inner seat width = effective seat width

** In increments of 20 mm

Dimensions and weights (front-wheel drive; mobility base = size 1)	
Armrest height (telescoping armrest)	Standard seat: 205–275 mm (8.1"–10.8") Standard seat, Junior: 185–225 mm (7.3"–8.8") VAS seat: 185–255 mm (7.3"–10")
Armrest length (standard)	260 mm (10.2")
Foremost point of the side panel (measured to back)	Minimum: 300 mm (11.8"); maximum: 580 mm (22.8")
Overall width (standard motor / high performance motor)*	596 / 612 mm (23.5" / 24.1")
Overall height (equipped with standard seat)	850–1110 mm (33.4"–43.7")
Overall height (equipped with VAS seat)	850–1110 mm (33.4"–43.7")
Overall length (without legrest)	908 mm (35.75")
Overall length (with legrest)	Minimum: 1050 mm (41.3"); maximum: 1250 mm (49.2")
Transport weights**	See "Weight", thereof weight of removable components: Legrest (standard): approx. 2.2 kg (4.9 lbs) Detachable side panel: approx. 3 kg (6.6 lbs) Legrest (power, with aluminium footplate): approx. 6.5 kg (14.3 lbs)
Minimum turning radius	965 mm (38")
Ground clearance	80 mm
Caster wheel tyre size	9"/10"
Drive wheel tyre size	14"

* Might be larger due to seat width adjustment. Overall width +180 mm in the assembled state.

** Weight of the heaviest component

Dimensions and weights (front-wheel drive; mobility base = size 2)	
Armrest height (telescoping armrest)	Standard seat: 205–275 mm (8.1"–10.8") Standard seat, Junior: 185–225 mm (7.3"–8.8") VAS seat: 185–255 mm (7.3"–10")
Armrest length (standard)	260 mm (10.2")
Foremost point of the side panel (measured to back)	Minimum: 300 mm (11.8"); maximum: 580 mm (22.8")
Overall width (standard motor / high performance motor)*	626 mm (24.6")
Overall height (equipped with standard seat)	850–1110 mm (33.4"–43.7")
Overall height (equipped with VAS seat)	850–1110 mm (33.4"–43.7")
Overall length (without legrest)	968 mm (38.1")
Overall length (with legrest)	Minimum: 1050 mm (41.3"); maximum: 1250 mm (49.2")
Transport weights**	See "Weight", thereof weight of removable components: Legrest (standard): approx. 2.2 kg (4.9 lbs) Detachable side panel: approx. 3 kg (6.6 lbs) Legrest (power, with aluminium footplate): approx. 6.5 kg (14.3 lbs)
Minimum turning radius	965 mm (38")
Ground clearance	80 mm
Caster wheel tyre size	9"/10"
Drive wheel tyre size	14"

* Might be larger due to seat width adjustment. Overall width +180 mm in the assembled state.

** Weight of the heaviest component

Dimensions and weights (rear-wheel drive; mobility base = size 1)	
Armrest height (telescoping armrest)	Standard seat: 205–275 mm (8.1"–10.8") Standard seat, Junior: 185–225 mm (7.3"–8.8") VAS seat: 185–255 mm (7.3"–10")
Armrest length (standard)	260 mm (10.2")

Dimensions and weights (rear-wheel drive; mobility base = size 1)	
Foremost point of the side panel (measured to back)	Minimum: 300 mm (11.8"); maximum: 580 mm (22.8")
Overall width (standard motor / high performance)*	596 / 612 mm (23.5" / 24.1")
Overall height (equipped with standard seat)	850–1110 mm (33.4"–43.7")
Overall height (equipped with VAS seat)	850–1110 mm (33.4"–43.7")
Overall length (without legrest)	850 mm (33.5")
Overall length (with legrest)	Minimum: 1050 mm (41.3"); maximum: 1250 mm (49.2")
Transport weights**	See "Weight", thereof weight of removable components: Legrest (standard): approx. 2.2 kg (4.9 lbs) Detachable side panel: approx. 3 kg (6.6 lbs) Legrest (power, with aluminium footplate): approx. 6.5 kg (14.3 lbs)
Minimum turning radius	965 mm (38")
Ground clearance	80 mm
Caster wheel tyre size	9"/10"
Drive wheel tyre size	14"

* Might be larger due to seat width adjustment. Overall width +180 mm in the assembled state.

** Weight of the heaviest component

Dimensions and weights (rear-wheel drive; mobility base = size 2)	
Armrest height (telescoping armrest)	Standard seat: 205–275 mm (8.1"–10.8") Standard seat, Junior: 185–225 mm (7.3"–8.8") VAS seat: 185–255 mm (7.3"–10")
Armrest length (standard)	260 mm (10.2")
Foremost point of the side panel (measured to back)	Minimum: 300 mm (11.8"); maximum: 580 mm (22.8")
Overall width (standard motor / high performance motor)*	642 mm (25.3")
Overall height (equipped with standard seat)	850–1110 mm (33.4"–43.7")
Overall height (equipped with VAS seat)	850–1110 mm (33.4"–43.7")
Overall length (without legrest)	870 mm (34.3")
Overall length (with legrest)	Minimum: 1050 mm (41.3"); maximum: 1250 mm (49.2")
Transport weights**	See "Weight", thereof weight of removable components: Legrest (standard): approx. 2.2 kg (4.9 lbs) Detachable side panel: approx. 3 kg (6.6 lbs) Legrest (power, with aluminium footplate): approx. 6.5 kg (14.3 lbs)
Minimum turning radius	965 mm (38")
Ground clearance	80 mm
Caster wheel tyre size	9"/10"
Drive wheel tyre size	14"

* Might be larger due to seat width adjustment. Overall width +180 mm in the assembled state.

** Weight of the heaviest component

Transportation size (storage length x storage width x storage height)	
Storage length	1100 mm (43.3")
Storage width	Minimum: 596 mm (23.5"); maximum: 630 mm (24.8")
Storage height	500 mm (19.7")

Seat and back adjustment	
Seat tilt*	Minimum: 0°; maximum: 45°
Set pre-tilt of the seat	-3°/0°/3°/6°/9° (depending on order)
Back angle**	Minimum: 90°; maximum: 120°

Seat and back adjustment	
Legrest angle***	Minimum: 90°; maximum: 165°
* Maximum value only with power seat tilt option; specifications do not take set pre-tilt into account	
** Specifications do not take set pre-tilt into account	
*** * Maximum value only with power legrest option + manually adjustable legrests; specifications do not take set pre-tilt into account	
Power seat functions	
Back angle adjustment*	Continuously adjustable by up to 30°
Seat tilt*	Adjustable by up to 45° (with centre of gravity shift)
Seat height adjustment*	Adjustable by up to 350 mm (13.8"); max. load capacity: 160 kg (353 lbs)
Combined seat height adjustment/seat tilt*	Seat height adjustment: adjustable by up to 350 mm (11.8"); seat tilt: adjustable by up to 45°; max. load capacity: 160 kg (353 lbs)
Legrests	Continuously adjustable by up to 75°
* Depending on equipment	
Seat function (manual)	
Back angle adjustment	Adjustable by up to 30°
Seat function (manual)	
Legrests	Adjustable by up to 75°
Tyres	
Tyre type	PU tyres
Tyres	
Tyre type	Pneumatic tyres
Tyre pressure	Adjust the tyre pressure according to the specifications on the tyre sidewall to prevent injuries or damage to the product: <ul style="list-style-type: none"> • 14" drive wheel: 3.5 bar/350 kPa/50 PSI • 10" caster wheel: 3.5 bar/350 kPa/50 PSI • 9" caster wheel: 3.5 bar/350 kPa/50 PSI • 9" caster wheel (Impac): 5.2 bar/520 kPa/75 PSI
Driving data	
Speed*	See nameplate for precise information: 6 km/h (3.7 mph); 7.2 km/h (4.4 mph); 10 km/h (6.2 mph); 14 km/h (8.7 mph)
Dynamic stability going downhill**	10° (17.5 %) (approved climbing ability with lowered seat functions, upright backrest and lowered legrests)
Static stability – uphill and downhill; sideways	10° (17.5 %)
Maximum obstacle height	With front-wheel drive: 75 mm (3") With rear-wheel drive: 50 mm (2"); with curb climbing assist: 100 mm (4")
Braking distance (according to DIN EN 12184:2014)***	At 6 km/h (3.7 mph): 1000 mm (39.4") – horizontal At 7.2 km/h (4.4 mph): 1200 mm (47.2") – horizontal At 10 km/h [6.2 mph]: 2100 mm (82.7") – horizontal At 14 km/h [8.7 mph]: 3900 mm (153.5") – horizontal

* The specified speed can vary by ±10%.

** The control unit and the motors have to be protected against overloading. For this reason, the continuous climbing ability depends on the overall weight (wheelchair weight + user weight + luggage) as well as the ground conditions, exterior temperature, battery voltage and driving style of the user. In individual cases, the continuous climbing ability can be significantly lower than the value specified.

*** The braking distance can be correspondingly longer due to user weight, luggage, installed options and condition of the tyres, and due to weather and surface conditions.

Range (on level surfaces)*	
Battery with 53 Ah (C5) / 62 Ah (C20)	approx. 26 km (16 miles)
* The specified range was determined under defined conditions according to ISO 7176-4. In practice the range can be reduced by up to 50% . For information on this, see the section "Range" in the instructions for use (user).	
Range (on level surfaces)*	
Battery with 63 Ah (C5) / 74 Ah (C20)	Approx. 35 km (22 miles)
* The specified range was determined under defined conditions according to ISO 7176-4. In practice the range can be reduced by up to 50 % . For information on this, see the section "Range" in the instructions for use (user).	
Range (on level surfaces)*	
Battery with 75 Ah (C5) / 80 Ah (C20)	approx. 40 km (24.8 miles)
* The specified range was determined under defined conditions according to ISO 7176-4. In practice the range can be reduced by up to 50% . For information on this, see the section "Range" in the instructions for use (user).	
Electrical system	
IP protection rating (according to DIN EN 60529)	IP44
Operating voltage	24 V DC
Lighting	
LED front light	24 V, maintenance-free
LED rear light	24 V, maintenance-free
Automatic circuit breaker	80 A; 100 A (see inscription on automatic circuit breaker)
Battery charger	For more information see the included battery charger instructions for use
Battery	
Batteries	2 x 12 V; 53 Ah (C5)/62 Ah (C20); AGM; maintenance-free
Battery	
Batteries	2 x 12 V; 63 Ah (C5)/74 Ah (C20); AGM; maintenance-free
Battery	
Batteries	2 x 12 V; 63 Ah (C5)/73 Ah (C20); gel; maintenance-free
Battery	
Batteries	2 x 12 V; 75 Ah (C5)/80 Ah (C20); AGM; maintenance-free
Battery (not delivered by Ottobock)	
Required specifications	2 x 12 V; up to max. 75 Ah (C5)/ up to max. 92 Ah (C20); gel or AGM; maintenance-free
Battery charger (not delivered by Ottobock)*	
Required minimum specifications	<p>Maximum current: 10 A; voltage: 220 V</p> <p>Isolation (class 2) according to IEC 335-2-29: 2010-11; protection rating: IP21 (Ottobock recommends battery chargers with a protection rating of IPX4)</p> <p>The battery charger fulfils the normative requirements of EN 12184:2014.</p> <p>This also includes the requirements according to ISO 7176-14:2008 (battery charger with reverse polarity protection; battery charger charges batteries to at least 80% within 8 hours; battery charger includes information regarding nominal capacity and the possibility of charging overnight; battery charger indicates that the battery is properly connected)</p> <p>The device fulfils the normative requirements of ISO 7176-21: 2009</p>
* For further details, see the instructions for use supplied with the battery charger.	
Control unit	
Model	VR2

Control unit	
Max. output current per motor	70 A
Seat functions that can be controlled	Maximum 2
Force for operating the joystick on the standard control panel	1.6 N

Control unit	
Model	R-Net (controller and control panel)
Max. output current per motor	90 A (1 x integrated seat function, direct control)
Force for operating the joystick on the standard control panel	1.6 N

Control unit	
Model	R-Net (controller and control panel)
Max. output current per motor	120 A (seat functions are controlled via the separate seat module)
Force for operating the joystick on the standard control panel	1.6 N

Allowable environmental conditions	
Operating temperature	-15 °C to +40 °C (5 °F to +104 °F)
Transport and storage temperature	-15 °C to +40 °C (5 °F to +104 °F)

Corrosion protection	
Corrosion protection	Cathodic dip coating / powder coating

11 Appendices

11.1 Threshold values for wheelchairs transportable by train

INFORMATION

- ▶ The products in this series fully satisfy the minimum technical requirements of regulation (EU) No. 1300/2014 regarding train accessibility for people with disabilities. However, not all versions can comply with all threshold values due to different settings.
- ▶ With the help of the table that follows, you or the qualified personnel can take measurements and verify whether the specific product in question meets the threshold values.

Feature	Threshold value (according to regulation (EU) No. 1300/2014)
Length	1200 mm (47.2"); plus 50 mm (2") for the feet
Width	700 mm (27.6"); plus 50 mm (2") on each side for the hands when moving
Smallest wheels	approx. 3" or greater according to the regulation, the smallest wheel must be able to accommodate a gap measuring 75 mm (3") horizontally and 50 mm (2") vertically
Height	max. 1375 mm (54.1"); including a 1.84 m (72.5") large male wheelchair user (95th percentile)
Turning radius	1500 mm (59.1")
Maximum weight	300 kg (661 lbs); for wheelchair with occupant, including baggage
Maximum obstacle height that can be overcome	50 mm (2")
Ground clearance	60 mm (2.4"); at an upward slope angle of 10°, ground clearance must measure at least 60 mm (2.4") under the foot rest for going forward at the end of the slope
Maximum inclination angle on which the wheelchair will remain stable	6° (dynamic stability in all directions) 9° (static stability in all directions, also when wheel lock engaged)



A series of horizontal lines spanning the width of the page, providing a template for writing or drawing.



A series of 22 horizontal lines spanning the width of the page, providing a template for handwriting practice.



A series of horizontal lines spanning the width of the page, providing a template for writing or drawing.

Kundenservice/Customer Service

Europe

Otto Bock HealthCare Deutschland GmbH
Max-Näder-Str. 15 · 37115 Duderstadt · Germany
T +49 5527 848-3433 · F +49 5527 848-1460
healthcare@ottobock.de · www.ottobock.de

Otto Bock Healthcare Products GmbH
Brehmstraße 16 · 1110 Wien · Austria
F +43 1 5267985
service-admin.vienna@ottobock.com · www.ottobock.at

Otto Bock Adria d.o.o. Sarajevo
Ramiza Salčina 85
71000 Sarajevo · Bosnia-Herzegovina
T +387 33 255-405 · F +387 33 255-401
obadria@bih.net.ba · www.ottobockadria.com.ba

Otto Bock Bulgaria Ltd.
41 Tzar Boris III' Blvd. · 1612 Sofia · Bulgaria
T +359 2 80 57 980 · F +359 2 80 57 982
info@ottobock.bg · www.ottobock.bg

Otto Bock Suisse AG
Luzerner Kantonsspital 10 · 6000 Luzern 16 · Suisse
T +41 41 455 61 71 · F +41 41 455 61 70
suisse@ottobock.com · www.ottobock.ch

Otto Bock ČR s.r.o.
Protetická 460 · 33008 Zruč-Senec · Czech Republic
T +420 377825044 · F +420 377825036
email@ottobock.cz · www.ottobock.cz

Otto Bock Iberica S.A.
C/Majada, 1 · 28760 Tres Cantos (Madrid) · Spain
T +34 91 8063000 · F +34 91 8060415
info@ottobock.es · www.ottobock.es

Otto Bock France SNC
4 rue de la Réunion · CS 90011
91978 Courtaboeuf Cedex · France
T +33 1 69188830 · F +33 1 69071802
information@ottobock.fr · www.ottobock.fr

Otto Bock Healthcare plc
32, Parsonage Road · Englefield Green
Egham, Surrey TW20 0LD · United Kingdom
T +44 1784 744900 · F +44 1784 744901
bockuk@ottobock.com · www.ottobock.co.uk

Otto Bock Hungária Kft.
Tatai út 74. · 1135 Budapest · Hungary
T +36 1 4511020 · F +36 1 4511021
info@ottobock.hu · www.ottobock.hu

Otto Bock Adria d.o.o.
Dr. Franje Tuđmana 14 · 10431 Sveta Nedelja · Croatia
T +385 1 3361 544 · F +385 1 3365 986
ottobockadria@ottobock.hr · www.ottobock.hr

Otto Bock Italia Srl Us
Via Filippo Turati 5/7 · 40054 Budrio (BO) · Italy
T +39 051 692-4711 · F +39 051 692-4720
info.italia@ottobock.com · www.ottobock.it

Otto Bock Benelux B.V.
Mandenmaker 14 · 5253 RC
Nieuwkuijk · The Netherlands
T +31 73 5186488 · F +31 73 5114960
info.benelux@ottobock.com · www.ottobock.nl

Industria Ortopédica Otto Bock Unip. Lda.
Av. Miguel Bombarda, 21 - 2º Esq.
1050-161 Lisboa · Portugal
T +351 21 3535587 · F +351 21 3535590
ottobockportugal@mail.telepac.pt

Otto Bock Polska Sp. z o. o.
Ulica Korolowa 3 · 61-029 Poznań · Poland
T +48 61 6538250 · F +48 61 6538031
ottobock@ottobock.pl · www.ottobock.pl

Otto Bock Romania srl
Șos de Centura Chitila - Mogoșoaia Nr. 3
077405 Chitila, Jud. Ilfov · Romania
T +40 21 4363110 · F +40 21 4363023
info@ottobock.ro · www.ottobock.ro

OOO Otto Bock Service
p/o Pultikovo, Business Park „Greenwood”,
Building 7, 69 km MKAD
143441 Moscow Region/Krasnogorskiy Rayon
Russian Federation
T +7 495 564 8360 · F +7 495 564 8363
info@ottobock.ru · www.ottobock.ru

Otto Bock Scandinavia AB
Koppargatan 3 · Box 623 · 60114 Norrköping · Sweden
T +46 11 280600 · F +46 11 312005
info@ottobock.se · www.ottobock.se

Otto Bock Slovakia s.r.o.
Röntgenova 26 · 851 01 Bratislava 5 · Slovak Republic
T +421 2 32 78 20 70 · F +421 2 32 78 20 89
info@ottobock.sk · www.ottobock.sk

Otto Bock Sava d.o.o.
Industrijska bb · 34000 Kragujevac · Republika Srbija
T +381 34 351 671 · F +381 34 351 671
info@ottobock.rs · www.ottobock.rs

Otto Bock Ortopedi ve
Rehabilitasyon Tekniği Ltd. Şti.
Mecidiyeköy Mah. Lati Lokum Sok.
Meriç Sitesi B Blok No: 30/B
34387 Mecidiyeköy-Istanbul · Turkey
T +90 212 3565040 · F +90 212 3566688
info@ottobock.com.tr · www.ottobock.com.tr

Africa

Otto Bock Algérie E.U.R.L.
32, rue Ahcène Outaleb - Coopérative les Mimosas
Mackle-Ben Aknoun · Alger · DZ Algérie
T +213 21 913863 · F +213 21 913863
information@ottobock.fr · www.ottobock.fr

Otto Bock Egypt S.A.E.
28 Soliman Abaza St. Mohandessein · Giza · Egypt
T +20 2 37606818 · F +20 2 37605734
info@ottobock.com.eg · www.ottobock.com.eg

Otto Bock South Africa (Pty) Ltd
Building 3 Thornhill Office Park · 94 Bekker Road
Midrand · Johannesburg · South Africa
T +27 11 564 9360
info-southafrica@ottobock.co.za
www.ottobock.co.za

Americas

Otto Bock Argentina S.A.
Av. Belgrano 1477 · CP 1093
Ciudad Autónoma de Buenos Aires · Argentina
T +54 11 5032-8201 / 5032-8202
atencionclientes@ottobock.com.ar
www.ottobock.com.ar

Otto Bock do Brasil Tecnica Ortopédica Ltda.
Alameda Maria Tereza, 4036, Bairro Dois Córregos
CEP: 13.278-181, Valinhos-São Paulo · Brasil
T +55 19 3729 3500 · F +55 19 3269 6061
ottobock@ottobock.com.br · www.ottobock.com.br

Otto Bock HealthCare Canada
5470 Harvester Road
Burlington, Ontario, L7L 5N5, Canada
T +1 800 665 3327 · F +1 800 463 3659
CACustomerService@ottobock.com ·
www.ottobock.ca

Oficina Ottobock Habana
Calle 3ra entre 78 y 80.
Edificio Jerusalem · Oficina 112 · Calle 3ra.
Playa, La Habana. Cuba
T +53 720 430 69 · +53 720 430 81
hector.corcho@ottobock.com.br
www.ottobock.com.br

Otto Bock HealthCare Andina Ltda.
Calle 138 No 53-38 · Bogotá · Colombia
T +57 1 8619988 · F +57 1 8619977
info@ottobock.com.co · www.ottobock.com.co

Otto Bock de Mexico S.A. de C.V.
Prolongación Calle 18 No. 178-A
Col. San Pedro de los Pinos
C.P. 01180 México, D.F. · Mexico
T +52 55 5575 0290 · F +52 55 5575 0234
info@ottobock.com.mx · www.ottobock.com.mx

Otto Bock HealthCare LP
11501 Alterra Parkway Suite 600
Austin, TX 78758 · USA
T +1 800 328 4058 · F +1 800 962 2549
USCustomerService@ottobock.com
www.ottobockus.com

Asia/Pacific

Otto Bock Australia Pty. Ltd.
Suite 1.01, Century Corporate Centre
62 Norwest Boulevard
Baulkham Hills NSW 2153 · Australia
T +61 2 8818 2800 · F +61 2 8814 4500
healthcare@ottobock.com.au · www.ottobock.com.au

Beijing Otto Bock Orthopaedic Industries Co., Ltd.
B12E, Universal Business Park
10 Jiuxianqiao Road, Chao Yang District
Beijing, 100015, P.R. China
T +8610 8598 6880 · F +8610 8598 0040
news-service@ottobock.com.cn
www.ottobock.com.cn

Otto Bock Asia Pacific Ltd.
Unit 1004, 10/F, Greenfield Tower, Concordia Plaza
1 Science Museum Road, Tsim Sha Tsui
Kowloon, Hong Kong · China
T +852 2598 9772 · F +852 2598 7886
info@ottobock.com.hk · www.ottobock.com

Otto Bock HealthCare India Pvt. Ltd.
20th Floor, Express Towers
Nariman Point, Mumbai 400 021 · India
T +91 22 2274 5500 / 5501 / 5502
information@indiaottobock.com · www.ottobock.in

Otto Bock Japan K. K.
Yokogawa Building 8F, 4-4-44 Shibaura
Minato-ku, Tokyo, 108-0023 · Japan
T +81 3 3798-2111 · F +81 3 3798-2112
ottobock@ottobock.co.jp · www.ottobock.co.jp

Otto Bock Korea HealthCare Inc.
4F Agaworld Building · 1357-74, Seocho-dong
Seocho-ku, 137-070 Seoul · Korea
T +82 2 577-3831 · F +82 2 577-3828
info@ottobockkorea.com · www.ottobockkorea.com

Otto Bock
South East Asia Co., Ltd.
Bangkok 10900 · Thailand
T +66 2 930 3030
F +66 2 930 3311
obsea@ottobock.co.th

Other countries

Otto Bock HealthCare GmbH
Max-Näder-Straße 15 · 37115 Duderstadt · Germany
T +49 5527 848-1590 · F +49 5527 848-1676
reha-export@ottobock.de · www.ottobock.com

Ihr Fachhändler | Your specialist dealer



Otto Bock Mobility Solutions GmbH
Lindenstraße 13 · 07426 Königsee-Rottenbach/Germany
www.ottobock.com

