

Airwheel A6S

USER MANUAL

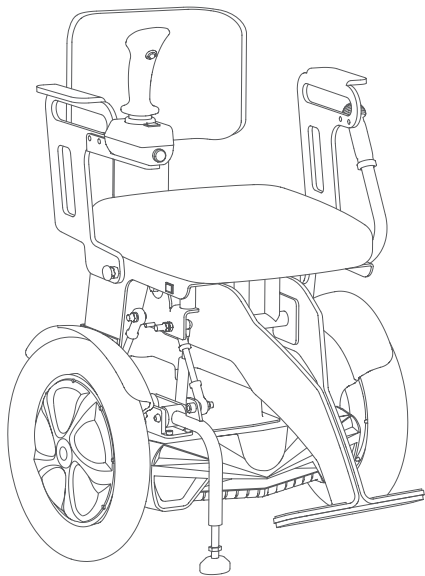

Check Packing Contents

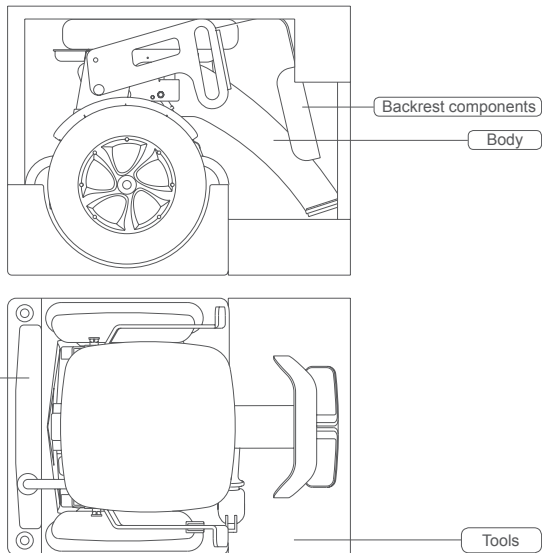

Packing list

Body	1pcs	Instruction	1unit
Adjustable operating arm	1pcs	Tools	1unit
Backrest components	1unit		

Diagram

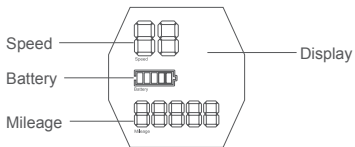
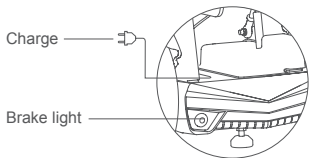
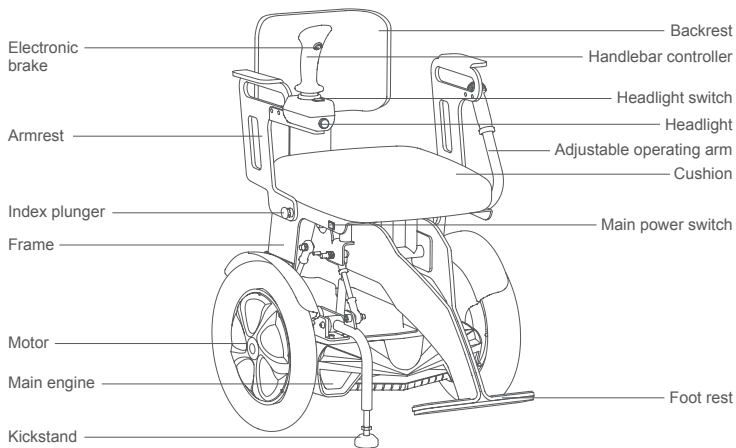

Use A6S

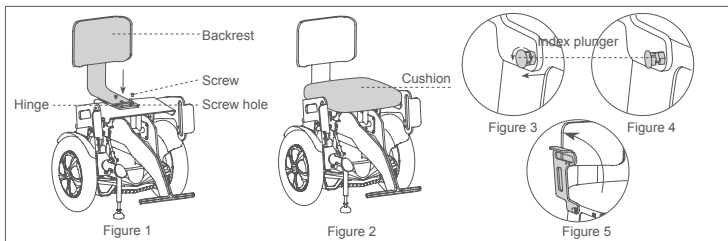

① Take A6S from the packing container. Align the screws on backrest hinge to the screw holes and body holes, tighten screws (see Figure 1) and stick saddle to frame (see Figure 2). Pull outward and rotate the index plunger (see Figure 3) and get the mount stuck and loosen the index plunger (see Figure 4); rotate the armrests to horizontal position (see Figure 5 - arrow). Pull outward and rotate the index plunger and release it when a click sound is heard.

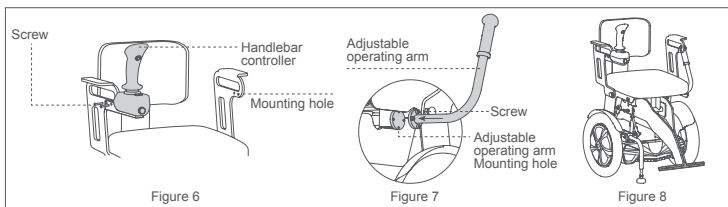

② Based on rider's habit, place the handlebar controller in the most appropriate position, tighten the screws and fix handlebar controller (see Figure 6), Remove the adjustable operating arm from the foam box, align the mounting holes (see Figure 7), tighten the screws and install the adjustable operating arm. Then the installation of the body is finished (see Figure 8).

The handlebar controller can be placed in right or left.

1. Loosen the screws with hex wrench (see right Figure) and dismantle the handlebar controller.
2. Place the handlebar controller in right or left based on rider's habit.
3. Tighten the screws and fasten the handlebar controller.

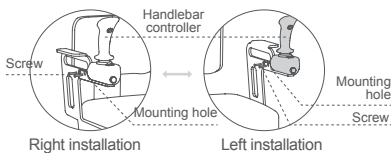

Adjust the kickstand height

Adjust the kickstand height according to riders' actual usage making the kickstand and tires in the same level. Loosen the kickstand nut (turn left to loose and right to tighten). Rotate the kickstand up and down to the right position and tighten the nut (see Figure 9).

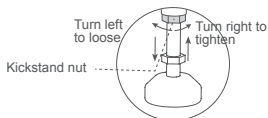

Figure 9

Adjust the depth of the backrest

Adjust the backrest depth according to riders' actual usage, unscrew the screws on both sides of the hinge, adjust it to appropriate adjusting hole and tighten the screws (see Figure 10).

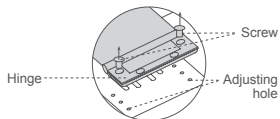

Figure 10

Specifications

Main Technical Parameters

Size	770X600X945mm	Item weight	~43.15kg
Folding size	770X600X610mm	Max. load	90kg
Tire size	14inch	Max. speed	6-9km/h
Charging voltage	AC100-240V 50-60Hz	Max. permissible gradient	~10°
Charging time	~180min	Battery capacity	520Wh
Saddle width	420mm	Backrest width	350mm
Saddle depth	420mm (15mm being adjustable)	Backrest depth	230mm
Applicable temperature	-10°C ~40°C		

Warning

1. Please do not throw away the waste battery, so as not to pollute the environment. The waste lithium battery of the product is to be recycled by the enterprise or dealer, and the government designated outlets.
2. After starting the kickstand adjusting gear, do not touch it whether by foot or hand, in case of accidents.
3. The handlebar controller can be pushed left or right. Pushing it forward or backward is forbidden in case of bringing damage to the handlebar controller.
4. Do not turn off power during riding.
5. Turn on the power switch first, then lift the adjustable mechanism.

Start and brake

1. Turn on the main power switch, startup prompt is heard and the display is continuously bright. Check whether the kickstand puts down or not. If not, push the adjustable operating arm backward until it cannot pull backward. Then kickstand lowers.
2. After the rider sits tight, push the adjustable operating arm forward until it cannot pull forward. Then kickstand rises. To go forward and backward, riders need to lean forward and backward and riders need rely on the handlebar controller to turn left or right.
3. Posture brake: change the center of gravity to the opposite direction of the movement to brake. For example, when you go forward, you can brake by leaning your body backward. Electronic brake: during riding, you can long press the electronic brake switch to decelerate and brake. When A6S decelerates or brakes, please release the electronic brake switch.

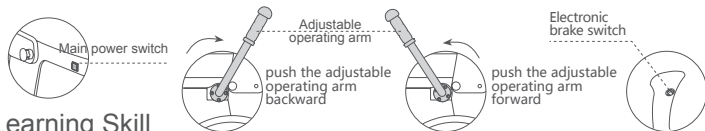

Learning Skill

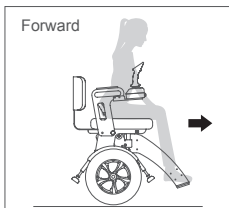

The body center of gravity slowly leans forwards

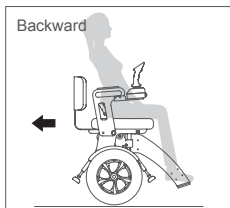

The body center of gravity slowly leans back

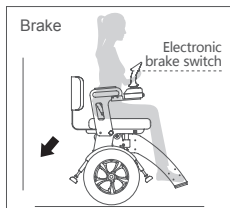

keep the body gravity in center / Long press the electronic brake switch

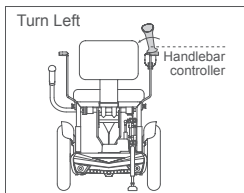

Turn the handlebar controller left

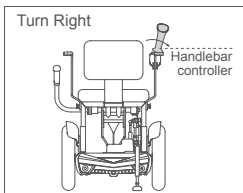

Turn the handlebar controller right

Safety

Please read this chapter as carefully as possible before your first-time using of this vehicle to fully understand all the information in order to drive it safely, comfortably and freely, which is important to you. If you have any question, please contact the manufacturer.

Important Note:

You need lots of practice to grasp the skill before you ride A6S safely. If you are not skilled, or fail to follow the user guide of this product, it may cause rider or others injury or property loss. Our company only takes the responsibility for product defects or damage, and we are NOT responsible for physical injury or property loss related with using products.

Attentions before operation

1. Get familiar with local traffic rules.
2. A6S belongs to non-motor vehicle, and requires no driving license in accordance with traffic law. But driver should observe the same traffic rules that are applied to pedestrians. Please drive it in pedestrian lane or bike lane.
 - (1) Get familiar with all the traffic signals marks used for pedestrians.
 - (2) Do not turn direction or cross road suddenly when driving on road.
3. Before your first time to operate A6S, please get familiar with all the functions of this vehicle. Practice the operations like moving forward, moving backward, increasing speed, reducing speed, stopping, moving uphill, moving downhill and turning direction in a safe pace with less people and good road condition. Then you can officially drive on road after getting familiar with all these operations.
4. If possible, please find a person familiar with A6S to accompany you to ensure your safety during first on-road operation.
5. Do not drive A6S after you drink, are exhausted or are unconscious to guarantee your safety.
6. Please confirm that the operator of this vehicle is not suffered from any mental disease or other diseases that may attack during driving and result in the driver's incompetence of driving the vehicle safely.
7. If you are taking medicine, please confirm from your doctor that if such medicine will have adverse influence on your ability to operate A6S.
8. Check the vehicle condition to confirm if the brake and various properties are normal.



- Never expose the electrical system of this vehicle to humid environment (such as rain, snow or fog), do not wash this vehicle with water, which will damage the electrical system. If the vehicle is wet, it could only be used after being dried and confirmed for good condition.
- Do not drive it under hostile weather conditions, such as rain, snow, fog, strong wind, temperature lower than -20°C or higher than 40°C . The electrical system may be damaged under those conditions to cause failures in control.
- Do no drive it on desert, beach, muddy road, road with pooled water, iced road, too smooth road or saline and alkaline land to prevent the driving property of this vehicle from damage.

Charging notes:

1. Carefully check whether the charger's rated input voltage (AC100-240V) and the grid voltage is consistent.
2. Verify that the charging indicator light (red) to confirm it is charging. When it turns green, it will take 15 minutes to be fully charged. The charging time is about 2-4 hours (depending on the quantity of remaining battery).
3. It is recommended to use it when battery is fully charged.
4. Before long-period storage, make sure it is fully charged, and charge it every 2 or 3 months.
5. When charging, keep it out of children's reach.

Battery usage:

1. Auxiliary charge: such as short delivery time, users can directly use the battery. If the delivery time is longer (2 months or longer), the battery will lose power during storage and transport. It is better to charge the battery before use. To charge it requires plugging the exclusive charge to the battery charging hole and connecting AC220V power source for 2~4 hours.
2. The normal charge of the battery: the operation of A6S is also the discharge process of the battery. The battery should be charged immediately after long time riding.
3. Always remember to power off after use.
4. The connectors of the battery box should be fixed tightly according to the requirements (the battery box connecting line has been reliably connected before ex-factory). Loosened or wrong connection will cause the related parts abnormal and lead to serious damage.
5. Lithium batteries can not be close to open fire or high temperature heat source, can not be thrown into water and can not be exposed in the sun in high temperature season.
6. Do not disassemble and decompose, as the internal part of them lithium battery has been packaged intactly.
7. The waste lithium battery of the product is to be recycled by the enterprise or dealer, and the government designated outlets. Please do not throw away the waste battery, so as not to pollute the environment.
8. Almost all kinds of batteries will be affected by the environment. In general, the electric discharge performance is better when the air temperature is high. When the temperature drops to 0 degrees centigrade, battery power may fall more than 1/3. So, in winter or in cold area, mileage reduction is normal. When the temperature rises to 20 degrees above, the range will recover.

Parking note:

1. Make sure it parks stably first, lower the lifting rod and then turn off power.
2. To ensure your safety and keep A6S's optimal state, please maintain it regularly.

Attentions during operation

1. A6S is designed with only one seat not allowing for taking passengers.
2. A6S is not intended to be used for moving or loading cargos.
3. The operator should sit on the seat and lean the body forward or backward to go forward or backward, and rely on the handlebar controller to turn left and right.
4. Do not drive in a zigzag manner, take a sudden turn at high speed or incline your body to prevent the vehicle from inclining to one side.
5. Please highly concentrate and drive slowly on uneven or soft road (such as grassland), when making a turn, on streets with a lot of traffic, in shopping centers or parks.
6. Do not use wireless communication devices such as mobile phone during driving. These devices could only be used when you stop the vehicle in a safe place and cut off the power supply.
7. When moving backward, pay attention to road conditions and pedestrians and drive at a slow speed.
8. Drive at a slow speed when getting out of door or elevator. It is not permitted to sit on it on escalator.
9. Keep highly concentrated and drive straightly at a slow speed when driving uphill or downhill. It does not permit to drive A6S across slopes exceeding 10° .
10. Follow traffic rules when driving through cross street and do not run a red light.
11. Do not frequently turn on or turn off the power switch.
12. Do not lend A6S to anyone who is not familiar with or has never used this vehicle. Do not let children play with the power switch or handlebar controller.
13. Do not use this vehicle with too much load (higher than 90KG).
14. The company is not liable for accidents, injuries or product malfunctions that result from unauthorized changes/modification or tampering with any part of original specifications. If something goes wrong, please contact Airwheel customer care.
15. This product might be limited to use on private road (check local regulations). We recommend using suitable protective equipment and installing reflector.

Airwheel reserves the right of final interpretation of all the terms and conditions of this User Manual.

Foldable

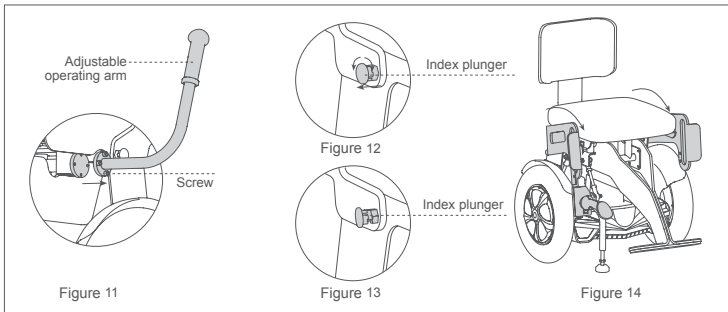

1 Loosen the set screw (see Figure 11) to remove the adjustable operating arm from the body. Pull outward and rotate the index plunger (see Figure 12) and get the mount stuck and loosen the index plunger (see Figure 13); rotate the armrests to horizontal position (see Figure 14-arrow). Pull outward and rotate the index plunger and release it when a click sound is heard. Then the armrest is folded .

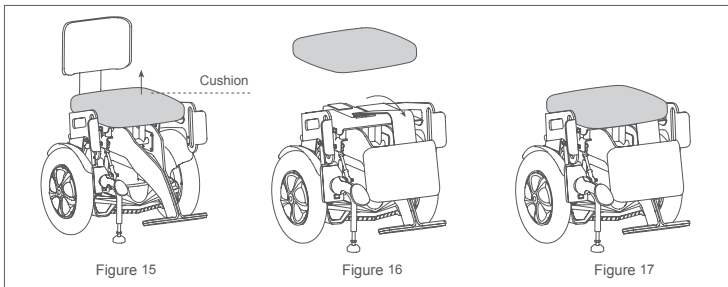

2 Split the saddle velcro tape, rotate backrest (see Figure 16 arrow), fold backrest and stick saddle to frame (see Figure 17). Then the backrest is folded.

Download APP



Scan QR code to download

*Applicable to Android 4.3 or higher, iOS 7.0 or higher.

APP Instructions

1. Turn on A6S power button, and start App and Bluetooth.
2. Click the search button and do as the follows to connect (verify password is 11111111).
3. Refer to official website or give calls for details.

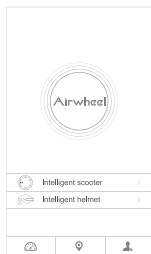

Click the Intelligent scooter in the App interface.

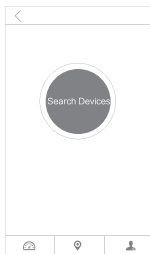

Click the search button or .

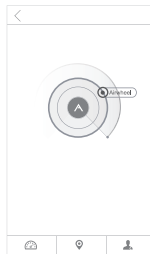

Search Airwheel nearby, click the searched Airwheel model to connect

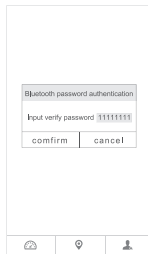

Input the verify password 11111111 to connect.