



USER GUIDE &
WARRANTY INFORMATION

BRUGERVEJLEDNING &
GARANTIOPLYSNINGER







Please ensure that a minimum of 0.7 litres (3 cups) of water is in your Uccello Kettle before every boil. Failure to do so, will substantially reduce the life of your Uccello Kettle and will adversely affect your guarantee.

Sørg for, at mindst 0,7 liter (3 kopper) vand er i din Uccello-kedel inden hver koge.
Hvis du ikke gør det, vil det betydeligt reducere din Uccello-kedel og dermed påvirke din garanti negativt.

Product Model/Code: UDK_BW
Manual v.7.0



PAGE CONTENTS

Know Your Kettle	pg 5
 Important Safety Instructions	pg 10
Operation	pg 14
Care and Cleaning	pg 15
Warranty	pg 16
Troubleshooting Guide	pg 18
 Vigtige Sikkerhedsinstruktioner	s. 22
Brug	s. 23
Pleje og Rengøring	s. 24
Garanti	s. 25
Fejlfindingsvejledning	s. 27
Thank You	pg 28

KNOW YOUR KETTLE / KEND DIN KEDEL

Main Parts / Hoveddele.

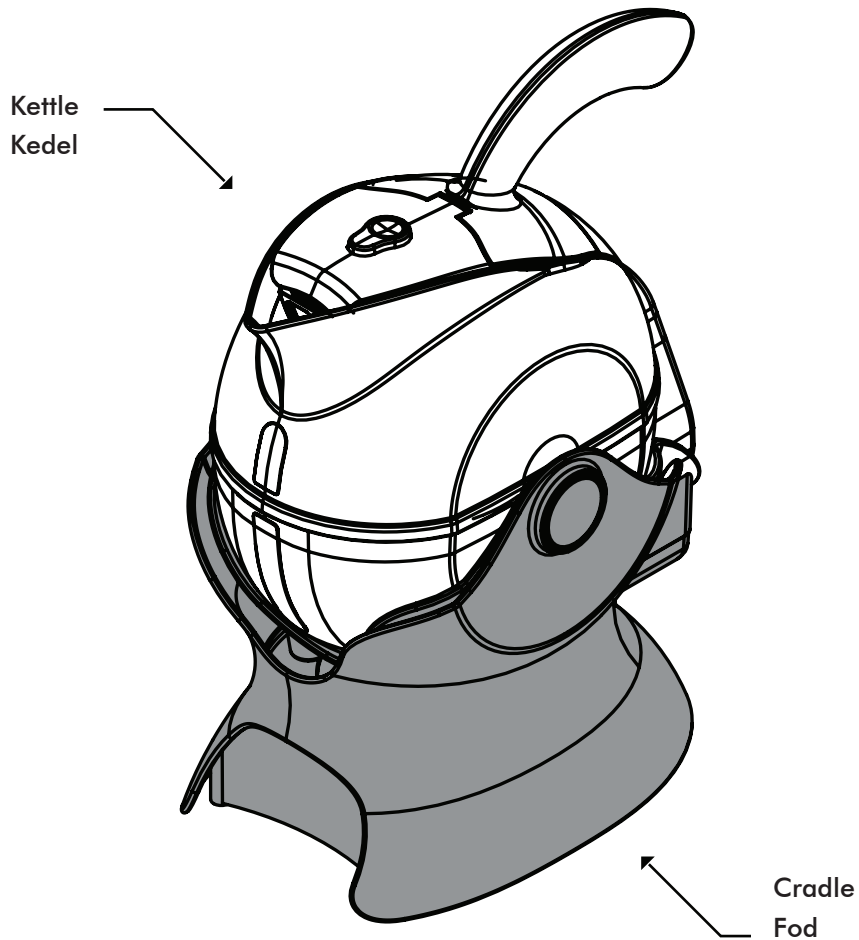

KNOW YOUR KETTLE / KEND DIN KEDEL

Kettle Parts / Kedeldele.

Open Lid Button
Knap til Åbning af Låg

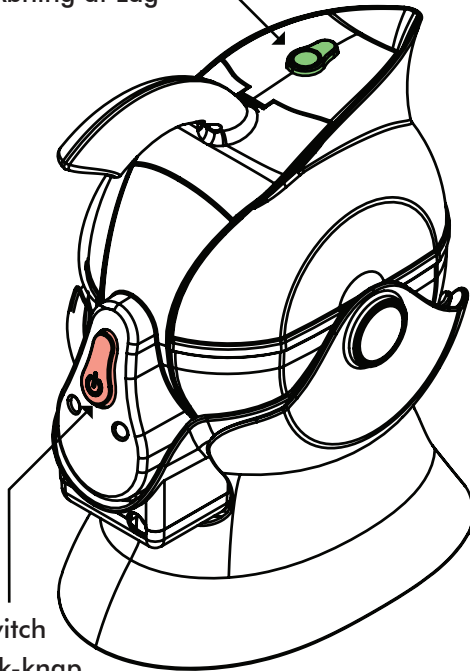

Water Level Indicator
Vandstandsindikator

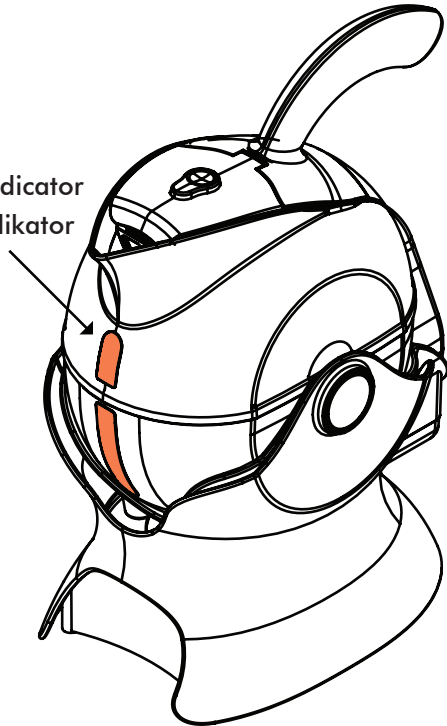

KNOW YOUR KETTLE / KEND DIN KEDEL

Detaching from the Cradle / Fjernelse fra Foden

The Uccello Kettle can be lifted out of the Cradle and used independently for pouring and filling. The Kettle can only be boiled whilst sitting in the Cradle.

- a) A short power-supply cord is provided to reduce risks resulting from becoming entangled in or tripping over a longer cord.
- b) Extension cords may be used if care is exercised in their use.
- c) If an extension cord is used:
 - 1) The marked electrical rating of the extension cord should be at least as great as the electrical rating of the appliance;
 - 2) If the appliance is of the grounded type, the extension cord should be a grounding type 3-wire cord; and
 - 3) The longer cord should be arranged so that it will not drape over the counter top or table top where it can be pulled on by children or tripped over.

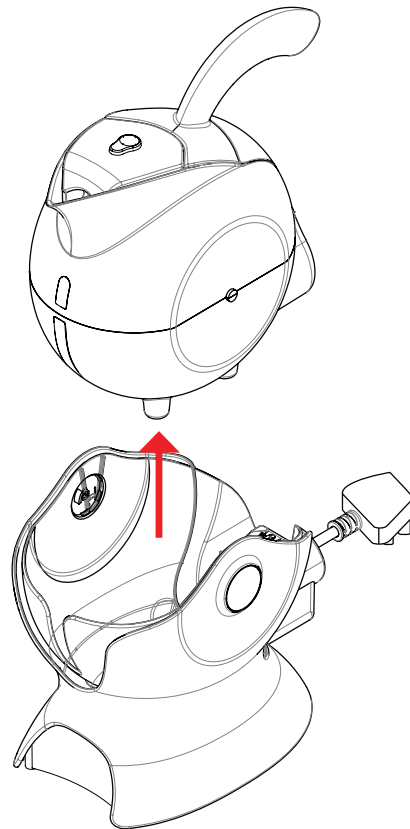

KNOW YOUR KETTLE / KEND DIN KEDEL

Detaching from the Cradle / Fjernelse fra Foden

Uccello Kedlen kan løftes op fra Foden, så man kan hælde fra den og fylde den op. Der må kun koges med kedlen, når den sidder i Foden.

- a) Den har en kort ledning, for at reducere risikoen for, at den vikles ind i eller vælter over en længere ledning.
- b) Der kan benyttes en forlængerledning, hvis man udviser forsigtighed ved brugen.
- c) Hvis der benyttes en forlængerledning:
 - 1) Skal forlængerledningen som minimum kunne holde til samme strømstyrke som apparatet bruger;
 - 2) Hvis apparatet er med jord, skal forlængerledningen være et 3-faset jordstik; og
 - 3) Den længere ledning skal arrangeres således, at den ikke lægger ud over disken eller bordet, hvor den kan trækkes i eller væltes af børn.

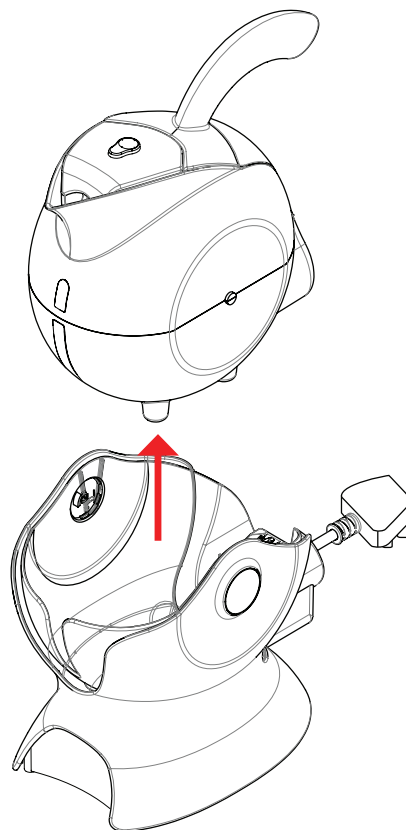

KNOW YOUR KETTLE / KEND DIN KEDEL

Unit Rotation / Rotation af Enheden

The Uccello Kettle, whilst in the Cradle, can rotate on a vertical axis up to 80°, allowing you to pour boiled water without the need to lift the Kettle.

Uccello Kedlen kan roteres op til 80° vertikalt, mens den sidder i Foden, så der kan hældes kogende vand fra den, uden man behøver at løfte Kedlen.

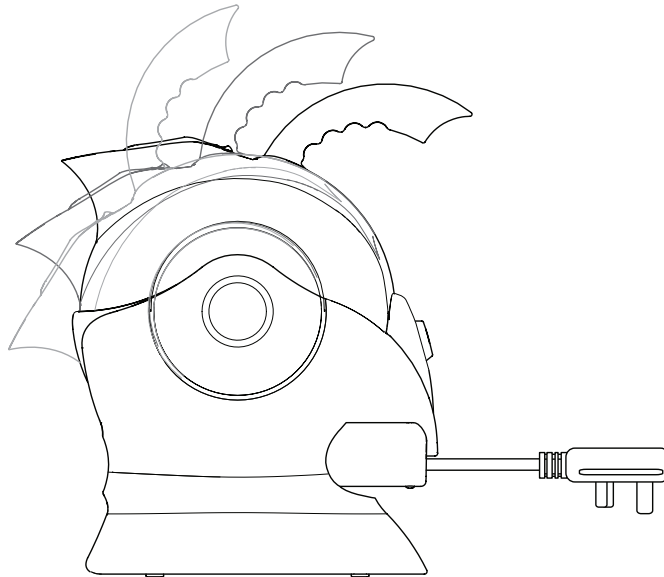



IMPORTANT SAFETY INSTRUCTIONS

When using electrical appliances, basic safety precautions should always be followed, including the following:



Please read all of this instruction manual before using your Uccello Kettle.

Store/save this manual in a safe place for future reference.

Before Use



Before connecting the Uccello Kettle to the power supply, check that the voltage indicated on the appliance corresponds with the voltage in your home. If this is not the case, do not use the Kettle and contact your Uccello Kettle Dealer.



Check that the cord supplied is free from defects. If the cord is damaged do not use the Kettle and contact your Uccello Kettle Dealer.

During/After Operation



Always fill the Uccello Kettle above the minimum (0.7L / 24fl. oz / 3 cups) and to below the maximum of (1.5L / 50fl.oz / 6 cups) as indicated on the kettle.



Should you accidentally operate the Uccello Kettle with less than the minimum amount of water it will result in irreparable damage to the kettle.



To avoid the risk of damaging the heater element inside the Uccello Kettle, do not operate the Kettle without water inside.



Should you accidentally operate the Uccello Kettle without water, the Boil-Dry protection will automatically switch the Kettle off. If this should occur, allow the Kettle to completely cool before filling with cold water and re-boiling. Repeated use without water will result in irreparable damage to the kettle.



Do not fill the Uccello Kettle beyond its maximum safe fill level of 1.5L / 50fl.oz / 6 cups (labelled MAX on the Water Level Indicator).



If the Uccello Kettle is overfilled, boiling water may overflow down the internal steam tube, into the electrics and it will result in irreparable damage to the kettle.



Boiling an overfilled kettle runs the risk of boiling water being ejected.



IMPORTANT SAFETY INSTRUCTIONS



Do not to tip the Uccello Kettle backwards as illustrated by the diagram below; doing so will cause water to pour from the back of the kettle and will damage it. This action is a misuse of your kettle.

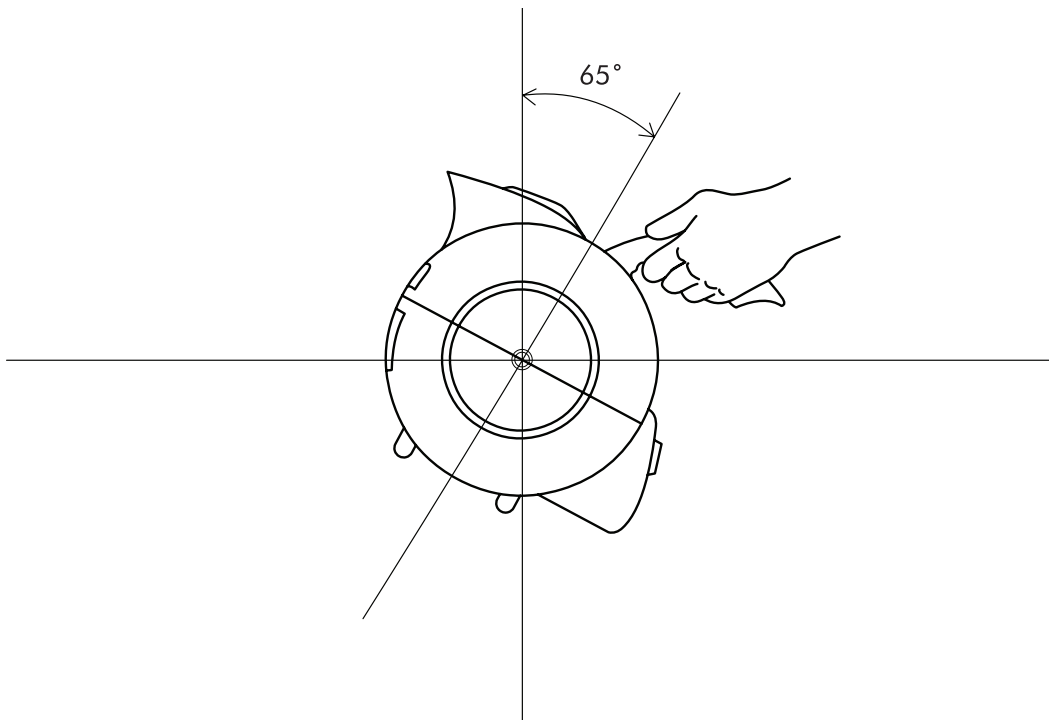

The Uccello Kettle should be used for boiling water only. Do not boil any other liquid or substance in the kettle.



Only operate the Uccello Kettle on a flat and stable surface, out of reach of children.



Extreme caution must be taken when handling the Uccello Kettle containing hot water.



IMPORTANT SAFETY INSTRUCTIONS



Be cautious of steam exiting the spout whilst boiling water and whilst opening the lid after the boiling cycle. Contact with steam can cause scalding. To avoid scalding, always ensure the lid is closed whilst the kettle is boiling.



Always take care when pouring boiling water. Make sure to pour slowly and carefully, ensuring not to tip the Uccello Kettle too fast.



Take care when opening the lid whilst the Kettle is hot.



Do not touch the Uccello Kettle whilst hot, except for the handle and the open lid button.



The Uccello Kettle is not a toy.



This appliance is not intended for use by persons (including children) with reduced physical, sensory or mental capabilities or lack of experience and knowledge unless they have been given initial supervision or instruction concerning the use of the appliance by a person responsible for their safety. Children should be supervised to ensure that they do not play with the appliance.



IMPORTANT SAFETY INSTRUCTIONS

General Safety Information



Only use the Cradle with the Uccello Kettle.



Only use the Uccello Kettle with the Cradle.



Unplug the Uccello Kettle from the power outlet when not in use and before cleaning. When cleaning, ensure the Uccello Kettle is completely cool.



Do not let the cord come into contact with hot surfaces. Do not place any or all parts of the Uccello Kettle on or near a hot gas plate or electric burner, or in a heated oven.



Do not let the power cord hang over the edge of tables, counters etc.



To avoid fire, electric shock or personal injury, do not immerse the cord, plug or Uccello Kettle in water or other liquids.



The use of attachments that are not recommended by Uccello Designs may result in fire, electric shock or personal injury.



The Uccello Kettle is intended to be used in household applications for domestic use. Do not use the Uccello Kettle outdoors.



The Uccello Kettle should be kept out of direct sunlight during use and storage.

When using electrical appliances, basic safety precautions should always be followed, including the following:

1. Close supervision is necessary when any appliance is used by or near children
2. Do not operate any appliance with a damaged cord or plug or after the appliance malfunctions, or has been damaged in any manner. Return appliance to the nearest authorized service facility for examination, repair or adjustment
3. To disconnect, turn any control to "off" then remove plug from wall outlet.

Save these instructions.



OPERATION

Before Initial Use

If you are using your Uccello Kettle for the first time, it is recommended that you clean your Kettle before use by boiling a full Kettle of water twice and then discarding the water.

Kettle Operation

NOTE: Do not fill the water over the maximum level as water may spill out of the spout when boiling. Ensure that the lid is firmly in place before connecting the power cord to the outlet.

1. Position the Uccello Kettle in the Cradle.
2. Connect the plug into a power outlet. Press the Switch Button below the handle. The Indicating light in the On/Off switch will light up. The Kettle will switch off automatically and the light will extinguish in the On/Off switch once the water has boiled. You can shut off the power by pressing the switch button at any point during boiling water.

NOTE: Ensure that switch is clear of obstructions and the lid is firmly closed. The Kettle will not turn off if the switch is constrained or if the lid is left open.

3. While holding the handle rotate the Uccello Kettle in the Cradle to pour the water.

NOTE: Operate carefully when pouring the water from your Uccello Kettle as boiling water may result in scalding. Do not open the lid while the water in the Kettle is hot.

Boil-Dry Protect

Should you accidentally allow the Uccello Kettle to operate without water, the Boil-Dry protection will automatically switch it off. If this should occur, allow the Uccello Kettle to cool for 30 seconds before filling with cold water and re-boiling.

Repeated dry boiling will result in irreparable damage to the kettle.



CARE AND CLEANING

Always disconnect the appliance from the power outlet before cleaning. Never immerse the Uccello Kettle or cord in water or allow moisture to contact these parts.

Removal of Mineral Deposits

Mineral deposits in tap water may cause the Uccello Kettle interior to discolour. To remove this build-up use Liquid Descaler, a simple to use, non-toxic cleaner.

Alternatively:

1. Fill the Uccello Kettle with 3 cups of white vinegar and the remainder with water and allow to stand overnight. **Do not boil.**
2. Empty the solution from the Kettle, any stains remaining inside the spout can be removed by rubbing with a damp cloth.
3. Fill the Kettle with clean water, bring to the boil and discard the water. Repeat. The Uccello Kettle is ready for use.

NOTE: The outside of the Kettle can be wiped over with a damp cloth.

NOTE: Do not use harsh chemicals when cleaning the kettle.

Cleaning the Cradle

Wipe the housing with a mild detergent and damp cloth.

Cleaning the Filter

Remember to clean the filter with a mild detergent and damp cloth at intervals. The filter can be detached for easier cleaning simply by pulling it out. To attach, insert the filter into the support dent.

Storage

When not in use or storage, the power cord may be wound around the cord storage under the bottom of Kettle.

Disposal

You can help protect the environment. Please remember to respect the local regulations: Hand in the non-working electrical appliance to an appropriate waste disposal centre.



WARRANTY & REGISTRATION

We have spent many, many hours carefully designing, and sourcing the best raw materials and components for our products, so they can be built to the highest standard possible.

You are entitled to have the product repaired or replaced if it fails to be of acceptable quality, even if the failure does not amount to a major failure.

To ensure prompt processing of any warranty claims, please complete the product registration online at <https://www.uccello designs.com> or alternatively complete the form on the next page and return to Uccello or its authorised agents to activate the warranty.

See page 17 for the conditions of the warranty.

WARRANTY TERMS & CONDITIONS

1. Warranty

Uccello Marketing, and its authorised agents, are the sole importers of Uccello branded products, and warrant to the original purchaser that all Uccello products purchased from an authorised stockist will be free from defects in materials and / or workmanship for the duration of the warranty from the date of purchase. Any product deemed faulty in terms of materials and / or workmanship that is returned to Uccello Marketing or the original place of purchase within the warranty period - 12 months from date of purchase, together with proof of purchase, will be replaced free of charge by Uccello Marketing or its authorised agents.

2. Exclusions

The warranty referred to above does not apply:

- I. To any defect of failure attributable to accident, misuse, abuse, negligence, including non-adherence to the prescribed operation instructions on the part of the user, or to
- II. Improper installation or connection to an inadequate or faulty power source;
- III. If the product has been serviced or repaired by any party not expressly authorized by Uccello Marketing to do so;
- IV. If any serial number has been removed or defaced;
- V. If the product is used outside the country of purchase;

3. Statutory Rights

The terms of the warranty set out herein are additional to, and in no way limit, vary or exclude any rights conferred by any conditions or warranties imposed by the provisions of the Trade Practices Act, 1974, Australia, and / or any applicable local legislation in the country of purchase.

This does not affect your statutory rights.



TROUBLESHOOTING GUIDE

No.	Issue	Possible Cause	Possible Solution
1	Kettle won't turn on	Kettle not energised	Check power supply to ensure that it corresponds to the model of the Uccello Kettle purchased - if not please return to point of purchase
2	Kettle won't turn on	Kettle not energised	Check power cord for defects. If a defect is found please return your Uccello Kettle to point of purchase
3	Kettle won't turn on	Kettle not energised	Ensure that the Uccello Kettle is placed correctly into the base as identified in this Instruction Manual
4	Kettle won't turn on	Kettle not energised	Ensure your BS 1362 compliant 13amp fuse is working (UK and Ireland only)
5	Kettle won't turn on	Insufficient water; dry-boil activated	Pour water into the Uccello Kettle, ensuring that the water level is over the minimum required amount (0.7 litre)
6	On/Off switch turns off immediately	Dry-boil activated as kettle has been boiled without the required amount water	Pour water into the Uccello Kettle, ensuring that the water level is over the minimum required amount (0.7 litre)
7	Water leaking from Kettle	Kettle tilted backwards beyond recommended angle	Empty water from kettle and dry comprehensively. Read "Safety Instructions" section in manual to identify correct use of the Uccello Kettle
8	Water leaking from Kettle	Kettle has been overfilled and boiled	Empty water from kettle and dry comprehensively. Refill the Uccello Kettle to above the minimum (0.7L / 24fl. oz / 3 cups) and to below the maximum of (1.5L / 50fl.oz / 6 cups) as indicated on the kettle.

If you are still unsure of the source of the issue, please return your Uccello Kettle to your point of purchase.



VIGTIGE SIKKERHEDSINSTRUKTIONER

Når man benytter elektriske apparater, bør man altid følge grundlæggende sikkerhedsforanstaltninger, inklusive følgende:



Læs venligst hele denne instruktionsmanual, før du benytter din Uccello Kedel.

Opbevar/gem denne manual et sikkert sted, så du kan finde den igen.

Før Brug



Før du slutter Uccello Kedlen til strøm, skal du tjekke at den spænding der er angivet på apparatet, svarer til spændingen i dit hjem. Hvis dette ikke er tilfældet, må du ikke benytte Kedlen og du skal kontakte din Uccello Kedel Forhandler.



Tjek at den medfølgende ledning er fri for defekter. Hvis ledningen er beskadiget, må du ikke benytte Kedlen og du skal kontakte din Uccello Kedel Forhandler.

Under/Efter Brug



Fyld altid Uccello Kedlen til over minimum (0.7L / 24fl. oz / 3 kopper) og under maksimum på (1.5L / 50fl.oz / 6 kopper), som angivet på kedlen.



Skulle du ved et uheld komme til at bruge Uccello Kedlen med mindre vand end minimum, vil det resultere i uoprettelig skade på kedlen.



For at undgå skader på varmeelementet inde i Uccello Kedlen, må Kedlen ikke bruges uden vand i.



Skulle du ved et uheld komme til at bruge Uccello Kedlen uden vand i, vil beskyttelsesfunktionen Boil-Dry automatisk slukke for Kedlen. Hvis dette skulle ske, så lad Kedlen køle helt ned før den fyldes med vand og sættes til at koge igen. Gentagen brug uden vand, vil resultere i uoprettelig skade på kedlen.



Fyld ikke Uccello Kedlen over det maksimale niveau på 1.5L / 50fl.oz / 6 kopper (angivet som MAX på Vandstandsindikatoren).



Hvis Uccello Kedlen overfyldes, kan der rinde vand ned i det indvendige damp rør eller ind i elektronikken, hvilket vil resultere i uoprettelig skade på kedlen.



Kogning med en overfyldt kedel, kan resultere i, at der sprøjter kogende vand ud.



VIGTIGE SIKKERHEDSINSTRUKTIONER



Tip ikke Uccello Kedlen bagover, som illustreret på diagrammet herunder; gør man det, vil der komme vand bagud af kedlen og dette vil beskadige den. Dette betragtes som misbrug af kedlen.

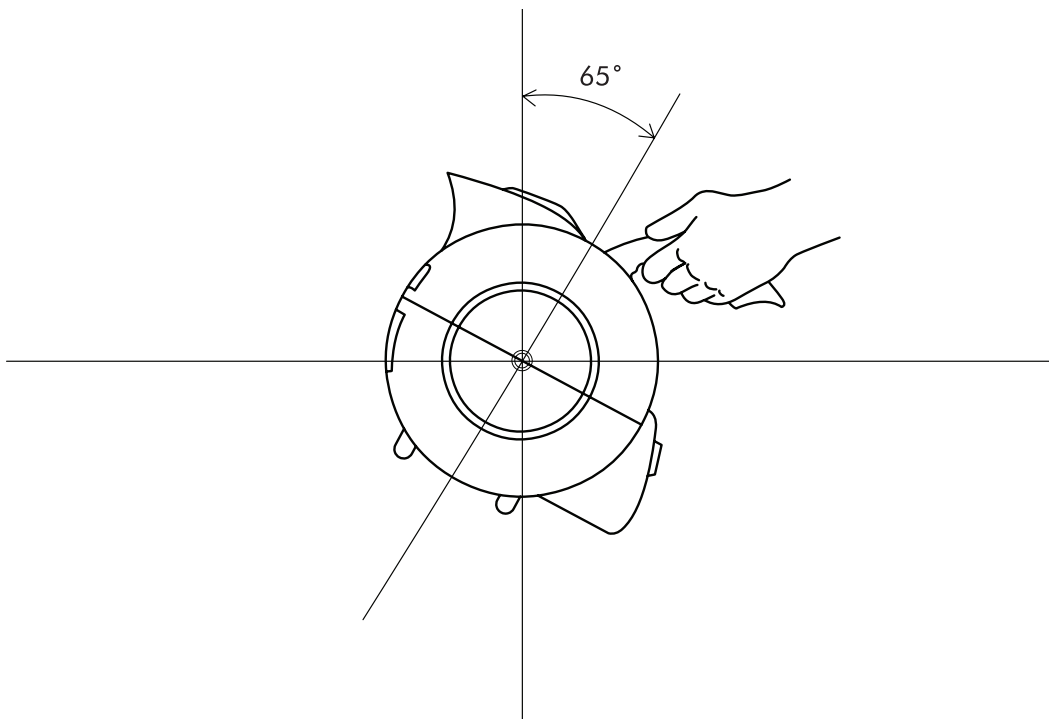

Uccello Kedlen må kun bruges til at koge vand i. Kog ikke andre væsker eller substanser i kedlen.









Brug kun Uccello Kedlen på en flad og stabil overflade, der er utilgængelig for børn.



Der skal udvises ekstrem forsigtighed, når man håndterer Uccello Kedlen mens der er varmt vand i.









VIGTIGE SIKKERHEDSINSTRUKTIONER

-  Pas på dampen der kommer ud af tuden, når der koges vand samt når der åbnes for låget efter kogning. Kontakt med damp kan forårsage skoldning. Sørg altid for at låget er lukket når kedlen koger, for at undgå skoldning.
-  Vær altid forsigtig, når der hældes kogende vand fra kedlen. Sørg for at hælde langsomt og forsigtigt, og sørg for ikke at tippe Uccello Kedlen for hurtigt.
-  Vær forsigtig, når der åbnes for låget mens Kedlen er varm.
-  Rør ikke ved Uccello Kedlen mens den er varm, rør kun håndtaget og knappen til at åbne låget.
-  Uccello Kedlen er ikke legetøj.
-  Dette apparat er ikke beregnet til brug af personer (inklusive børn) med nedsatte fysiske, sensoriske eller mentale evner, eller mangel på erfaring og viden, med mindre de har fået indledende træning eller instruktioner vedrørende brugen af apparatet af en person der er ansvarlig for deres sikkerhed. Der skal holdes opsyn med børn, så det sikres at de ikke leger med apparatet.



Generelle Sikkerhedsoplysninger

-  Brug kun Foden med Uccello Kedlen.
-  Brug kun Uccello Kedlen med Foden.
-  Tag Uccello Kedlen ud af stikkontakten, når den ikke bruges, eller når den skal rengøres. Sørg for at Uccello kedlen er fuldstændig kold, når den skal rengøres.
-  Lad ikke ledningen komme i kontakt med varme overflader. Placér ikke nogen dele fra Uccello Kedlen, eller selve kedlen, på eller nær et varmt komfur eller i en varm ovn.
-  Lad ikke ledningen hænge ud over bordkanter, diske osv.
-  For at undgå brand, elektrisk stød eller personskader, må ledningen, stikket eller Uccello Kedlen ikke puttes i vand eller andre væsker.



VIGTIGE SIKKERHEDSINSTRUKTIONER



Brug af tilbehør der ikke er anbefalet af Uccello Designs, kan resultere i brand, elektrisk stød eller personskader.



Uccello Kedlen er beregnet til indendørs husholdningsformål. Brug ikke Uccello Kedlen udendørs.



Uccello Kedlen må hverken stå i direkte sollys under brug eller når den ikke er i brug.

Når man benytter elektriske apparater, bør man altid følge grundlæggende sikkerhedsforanstaltninger, inklusive følgende:

1. Der skal altid holdes tæt opsyn, når apparatet benyttes af eller nær børn
2. Brug ikke apparatet med en beskadiget ledning eller et beskadiget stik, eller efter defekter på apparatet, eller hvis den på en eller anden måde er blevet beskadiget. Returnér apparatet til nærmeste serviceforhandler for undersøgelse, reparation eller justering
3. Når apparatet skal kobles fra, skal alting slås over på "off", før man tager stikket ud af stikkontakten

Gem disse instruktioner.



BRUG

Før Første Ibrugtagning

Før du bruger din Uccello Kedel første gang, anbefales det at du rengør din Kedel ved at koge en hel Kedel med vand to gange, og derefter kassere vandet.

Brug af Kedlen

BEMÆRK: Fyld ikke vand over det maksimale niveau, da der kan komme vand ud af tuden under kogning. Sørg for at låget er lukket helt, før stikket sættes i stikkontakten.

1. Placér Uccello Kedlen i Foden.
2. Sæt stikket i stikkontakten. Tryk på Tænd Knappen under håndtaget. Indikatorlyset i Tænd/Sluk knappen vil lyse op. Når vandet er kogt, slukker kedlen automatisk, hvorefter lyset i Tænd/Sluk knappen også slukkes. Du kan til enhver tid slukke for apparatet under kogning af vand, ved at trykke på tænd-knappen.

BEMÆRK: Sørg for at kontakten er fri samt at låget er lukket helt. Kedlen slukker ikke hvis kontakten holdes nede, eller hvis låget er åbent.

3. Rotér Uccello Kedlen i Foden, mens du holder i håndtaget, for at hælde vandet ud.

BEMÆRK: Vær forsigtig når du hælder vandet ud af din Uccello Kedel, da kogende vand kan forårsage skoldning. Åbn ikke låget mens vandet i Kedlen er varmt.

Boil-Dry Beskyttelse

Skulle du ved et uheld komme til at bruge Uccello Kedlen uden vand, vil beskyttelsesfunktionen Boil-Dry automatisk slukke den. Hvis dette skulle ske, skal Uccello Kedlen køles ned i 30 sekunder, før den fyldes med koldt vand og sættes til at koge igen.

Gentagen kogning uden vand, vil resultere i uoprettelig skade på kedlen.



PLEJE OG RENGØRING

Tag altid apparatet ud af stikkontakten før rengøring. Læg aldrig Uccello Kedlen eller ledningen i vand, og lad aldrig disse dele komme i kontakt med fugt.

Fjernelse af Mineralske Aflejringer

Mineralske aflejringer fra postevand kan misfarve Uccello Kedlen indvendigt. Brug Flydende Afkalker til at fjerne disse, da det er et ugiftigt rengøringsmiddel der er let at bruge.

Alternativt:

1. Fyld 3 kopper hvid eddike i Uccello Kedlen og resten med vand, og lad den stå natten over. Kog det ikke.
2. Tøm Kedlen for blandingen, eventuelle pletter i tuden kan fjernes med en fugtig klud.
3. Fyld Kedlen med rent vand, få det op at koge og hæld vandet ud. Gentag. Uccello Kedlen er nu klar til brug.

BEMÆRK: Kedlens yderside kan rengøres med en fugtig klud.

BEMÆRK: Brug ikke skrappe kemikalier til at rengøre kedlen.

Rengøring af Foden

Tør huset af med et mildt rengøringsmiddel og en fugtig klud.

Rengøring af Filteret

Sørg for regelmæssigt at rengøre filteret med et mildt rengøringsmiddel og en fugtig klud. Filteret kan tages af ved blot at trække den ud, så den bliver nemmere at rengøre. Når den skal sættes i, placeres filteret i den støttende fordybning.

Opbevaring

Når den ikke er i brug eller når den opbevares, kan ledningen vikles rundt om holderen under bunden af Kedlen.

Bortskaffelse

Du kan hjælpe med at beskytte miljøet. Sørg for at respektere de lokale regulativer: Aflever det defekte elektriske apparat på et passende bortskaffelsescenter.



GARANTI & REGISTRERING

Vi har brugt rigtig mange timer på omhyggeligt at designe og indkøbe de bedste råmaterialer og komponenter til vores produkter, så de kan fremstilles efter den højest mulige standard.

Du har ret til at få produktet repareret eller byttet, hvis den ikke er af acceptabel kvalitet, og selv hvis fejlen ikke skyldes en stor defekt.

For at sikre en hurtig behandling af reklamationer, bedes du udfylde produktregistreringen online på <https://www.uccelodesigns.com> eller alternativt udfylde formularen på næste side, og derefter returnere produktet til Uccello eller en af deres autoriserede forhandlere, for at udnytte garantien.

Se side 26 for garantiens betingelser.

GARANTI VILKÅR & BETINGELSER

1. Garanti

Uccello Marketing og deres autoriserede forhandlere er eneimportører af Uccello-produkter, og garanterer den originale køber, at alle Uccello-produkter købt fra en autoriseret forhandler er fri for defekter på materialer og / eller fabrikationsfejl under hele garantiperioden, gældende fra købsdatoen. Ethvert produkt der skønnes defekt i forhold til materialer og / eller fabrikationsfejl, og som returneres til Uccello Marketing eller det originale købssted, indenfor garantiperioden – 12 måneder fra købsdatoen, sammen med kvitteringen, byttes gratis af Uccello Marketing eller deres autoriserede forhandlere.

2. Undtagelser

Ovenstående garanti gælder ikke:

- I. Defekter eller fejl der skyldes uheld, misbrug eller uagtsomhed, inklusiv manglende overholdelse af de foreskrevne brugsinstruktioner fra brugerens side, eller
- II. Forkert installation eller forbindelse til en utilstrækkelig eller defekt strømkilde;
- III. Hvis produktet er blevet serviceret eller repareret af en part, der ikke er autoriseret af Uccello Marketing;
- IV. Hvis et serienummer er blevet fjernet eller er blevet ulæseligt;
- V. Hvis produktet bruges udenfor købslandet;

3. Lovbestemte Rettigheder

Garantiens betingelser der er angivet heri, er et supplement til, og begrænser, varierer eller udelukker på ingen måde rettigheder tillagt eventuelle betingelser eller garantier, der er pålagt af bestemmelserne i Trade Practices Act, 1974, Australien, og / eller enhver gældende lokal lovgivning i købslandet.

Dette påvirker ikke dine lovbestemte rettigheder.



FEJLFINDINGSVEJLEDNING

Nr.	Problem	Mulig Årsag	Mulig Løsning
1	Kedlen vil ikke tænde	Ingen strøm til kedlen	Tjek strømforsyningen for at sikre, at den svarer til den købte Uccello Kedel model – hvis ikke, så returner den venligst til købsstedet
2	Kedlen vil ikke tænde	Ingen strøm til kedlen	Tjek ledningen for defekter. Hvis der findes en defekt, så returner venligst din Uccello Kedel til købsstedet
3	Kedlen vil ikke tænde	Ingen strøm til kedlen	Sørg for at Uccello Kedlen er placeret korrekt i foden, som angivet i denne Instruktionsmanual
4	Kedlen vil ikke tænde	Ingen strøm til kedlen	Sørg for at din BS 1362 kompatible 13amp sikring virker (kun England and Irland)
5	Kedlen vil ikke tænde	Utilstrækkeligt vand; dry-boil er aktiveret	Hæld vand i Uccello Kedlen, og sørg for at vandniveauet er over minimumsmængden (0.7 liter)
6	Tænd/Sluk knappen slukker med det samme	Dry-boil er aktiveret da kedlen har kogt uden den rette mængde vand	Hæld vand i Uccello Kedlen, og sørg for at vandniveauet er over minimumsmængden (0.7 liter)
7	Der lækker vand fra Kedlen	Kedlen er tippet mere bagover en den anbefalede vinkel	Tøm kedlen for vand og tør den grundigt. Læs sektionen med "Sikkerhedsinstruktioner" i manualen, for at se korrekt brug af Uccello Kedlen
8	Der lækker vand fra Kedlen	Kedlen er blevet overfyldt og har kogt	Tøm kedlen for vand og tør den grundigt. Genopfyld Uccello Kedlen til over minimum (0.7L / 24fl. oz / 3 kopper) og under maksimum på (1.5L / 50fl.oz / 6 kopper), som angivet på kedlen.

Hvis du stadig er usikker på kilden til problemet, så returner venligst din Uccello Kedel til købsstedet.



THANK YOU FOR PURCHASING A PRODUCT FROM UCCELLO DESIGNS!

We trust it will provide you with many years of reliable service.

If experiencing any difficulties with the product, please see the warranty section within this instruction manual for further information.

To register your Uccello Kettle, visit our website at www.uccello designs.com



TAK FORDI DU HAR KØBT ET PRODUKT FRA UCCELLO DESIGNS!

Vi har tillid til at den vil tjene dig trofast i mange år.

Hvis du oplever problemer med produktet, så se venligst garantisektionen i denne instruktionsmanual for yderligere information.

Besøg vores hjemmeside på www.uccello designs.com, for at registrere din Uccello Kedel

