

**drive**

**DeVilbiss**  
HEALTHCARE

Shell seats  
***Integra***  
***& Selectis***

## **USER GUIDE**



***Integra***



***Selectis***

**CE**

More information :



# USER AND MAINTENANCE MANUAL FOR *Integra et Selectis* SHELL SEATS

## FOREWORD

Thank you and congratulations for buying a Drive DeVilbiss Healthcare France chair. Understanding well and maintaining regularly the chair will prolong its service life. That is the reason why we recommend reading this user and maintenance manual to better know the chair performances and qualities.

**Warning:** Drive DeVilbiss Healthcare France offers a wide range of chairs and equipment. The product, functions and accessories appropriateness should always be checked by a healthcare professional and a service provider.

The shell seats are products intended for patients who are unable to remain seated without support.

The patients using a shell chair should be accompanied by a caregiver when they handle the chair, especially they are equipped with the seating base, and generally, when sitting down in the chair and when leaving the chair.

## TABLE OF CONTENT

### I - INTENDED USE

1.1 - Target users.....	p 2
1.2 - Indications.....	p 2
1.3 - Contraindications.....	p 2
1.4 - Reuse.....	p 2

### 2 - WARNINGS

2.1 - Meaning of the symbols.....	p 3
2.2 - Controls before any use.....	p 3
2.3 - Outdoors use.....	p 3
2.4 - Prohibited use.....	p 3
2.5 - Surface temperature.....	p 3
2.6 - Environment.....	p 3
2.7 - Safety with electrical components.....	p 3

### 3 - SAFETY INSTRUCTIONS

3.1 - Carrying and lifting.....	p 4
3.2 - Transport in a vehicle.....	p 4
3.3 - Pinching risks.....	p 4
3.4 - Accessories and options.....	p 4
3.5 - Positioning.....	p 4
3.6 - General safety rules.....	p 4
3.7 - Precautions relative to electromagnetic compatibility.....	p 4

### 4 - DELIVERY AND COMMISSIONING.....

### 5 - USE RECOMMENDATIONS

5.1 - Seat belt.....	p 4
5.2 - For maximum stability.....	p 5
5.3 - Driving indoors.....	p 5
5.4 - Clearing an obstacle.....	p 5
5.5 - Leaning forward.....	p 5
5.6 - Leaning backward.....	p 5
5.7 - Transferring.....	p 5

### 6 - REGULAR MAINTENANCE

6.1 - Use and storage conditions.....	p 5
6.2 - Regular maintenance.....	p 5
6.3 - Cleaning.....	p 5

### 7 - MAINTENANCE

7.1 - Disinfecting.....	p 6
-------------------------	-----

### 8 - YEARLY MAINTENANCE, REPAIRING, WARRANTY

8.1 - Main procedures.....	p 6
8.2 - Accessories.....	p 6
8.3 - Storage.....	p 6
8.4 - Chair service life and end of life.....	p 6
8.5 - Warranty conditions.....	p 7

### 9 - OPTIONS AND TECHNICAL INFORMATION

9.1 - General presentation.....	p 7
9.2 - General terminology.....	p 7
9.3 - Options.....	p 8

### 10 - ASSEMBLY AND ADJUSTMENTS

10.1 - Seat depth (only on M version).....	p 9
10.2 - Seat height.....	p 9
10.3 - Standard or ergonomic headrest.....	p 9
10.4 - Side shelf.....	p 9
10.5 - Seating pad.....	p 9
10.6 - Shell tilting.....	p 10
10.7 - Transfer aid.....	p 10
10.8 - Footrest plate adjustment.....	p 10
10.9 - 3-point pelvic belt and harness.....	p 11
10.10 - Braking of the wheelbase.....	p 11
10.11 - Braking the institution leg.....	p 11
10.12 - Lap shelf.....	p 11
10.13 - Battery operation.....	p 11

## I - INTENDED USE

### 1.1) Target users

Drive DeVilbiss Healthcare France chairs are manufactured and tested in our factory. Choosing, adapting, and adjusting the chairs should be performed by a healthcare professional according to the user's pathology and needs. The use, security, and maintenance instructions should be explained to the user by healthcare professionals or medical device distributors, who should also make sure the user understands those instructions.

### 1.2) Indications

*Integra* and *Selectis* are multiversion shell seats for institutions. They suit users with reduced autonomy.

*Integra* and *Selectis* chairs particularly suit adults. They are easy-to-manoeuvre chairs, which can be used indoors and outdoors, but exclusively on good quality grounds, such as terraces or domestic routes out of road use. Thanks to various options, such as ergonomic headrest, legrest, and so on, the chairs can be adapted to various needs.

### 1.3) Contraindications

Only healthcare professionals are allowed to prescribe this chair, recommend the options and adjustments to comply so as to comply with the expected result. This chair is not suitable for children or users whose weight is less than 40 kg. The user should have the physical and mental capacities necessary for him/her, and his/her family, to safely use the chair.

# USER AND MAINTENANCE MANUAL FOR *Integra et Selectis* SHELL SEATS

## 1.4) Reuse

In case another user will reuse this chair, this latter should be cleaned, disinfected, and totally revised by an approved engineering centre. Then, a healthcare professional will appropriately adjust and adapt the chair to the new user.

It is important to check the original labels are present on the chair, to train the new user and to give him/her the user guide.

## II - WARNINGS



Please read carefully for your own safety:

- Do not use as a passenger seat in a vehicle, even if it is equipped and strapped.
- Never go onto an escalator.
- Do not fasten the seatbelt of the patient when using the Transfer in standing position function.
- Never sit on the legrest, the backrest or the armrests.
- Do not smoke when sitting in the chair.
- Always respect the mentioned maximum user weight.
- Always make sure there is no obstacle likely to prevent the chair from moving.
- Always lock the brakes when you go into or out from the seat.
- The footrest (option) should always touch the floor when the chair is in trendelenburg (tilted forwards).

### 2.1) Meaning of the symbols

	Operating weight in security
	Caution: hazard!
	Carefully read the user manual
	Device compliant to directive 93/42 EEC
	Manufacturer of the device
	Serial number

The information plate is glued on the tube under the shell seat legrest.

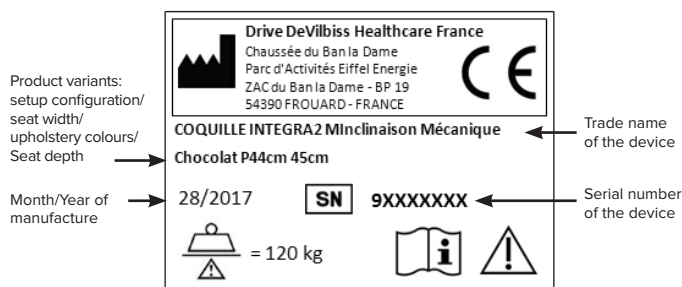

### 2.2) Controls before any use

Before any use, the user or the accompanying person should check the chair properly works.

Never use the chair if a fastening component is loosened, if a wheel or a chair part has abnormal play or if the upholstery elements are torn or undone.

### 2.3) Outdoors use

The chair can be used outdoors, provided that the use is limited to terraces, interior courtyards, and private roads; and the user should be always accompanied by someone who should take into account the road and weather conditions. In case of important ramps, slopes, kerbs, or superelevations, the chair may tip over. When moving, the chair should be slightly tilted backward in order to obtain maximum stability and to reduce driving efforts.

### 2.4) Prohibited use

The chair should not be used to carry heavy objects or for any other use than maintaining a person whose weight does not exceed the maximum permissible weight. Never use the chair when it is not in good condition.

### 2.5) Surface temperature

If the chair is exposed to a heat source, such as a heater or the sunrays, either directly or through a windowpane, the temperature of the upholstery, and metallic and plastic parts may be very high and burn the user. Those elements should be cooled before using the chair.

### 2.6) Environment

It is important to take into account the environment in which the chair is used. Always check door widths and doorsteps are compatible with the chair dimensions; watch out nearby stairs and protruding objects hanging from walls or from edges, and that could fall or hurt the user in the chair.

### 2.7) Safety with electrical components

- Unplug the outlet when the chair is not used.
- Check the power supply or remote control cord is not pinched or trapped into the mechanism underneath the chair or underneath the wheels.
- See chapter 10.12.

## III - SAFETY INSTRUCTIONS

 The footrest (option) should always touch the floor when the chair is in trendelenburg (tilted forwards).

### 3.1) Carrying and lifting

It is totally forbidden to lift the chair when the user is seating on. To lift the chair alone, exclusively use the fixed frame parts. Never use the legrest.

### 3.2) Transport in a vehicle

*Integra* and *Selectis* chairs should never be used as a passenger seat in a vehicle, even if it is equipped and strapped. If the chair is to be transported in a vehicle, it is preferable to anchor it with straps in order to secure it and remove the possible accessories (shelf, etc.).

 **CAUTION:** the weight of the chair or of some parts may be so heavy, that it may be necessary to be helped for lifting.

### 3.3) Pinching risks

There may be some pinching risks when handling the chair or the accessories. The healthcare professional should warn the user against those risks.

### 3.4) Accessories and options

Thanks to the different options, such as the ergonomic headrest, and some other devices, listed in this manual, the healthcare professional can adapt the chair to the user's needs. In no case should some other devices or options be associated to the chair before being sure they are compatible. Only the accessories provided by Drive DeVilbiss Healthcare France should be used.

### 3.5) Positioning

(pressure of the human body onto the soft tissues)

Some users suffer from pathologies favouring bedsores when they are seating for long whiles. It is the healthcare professional's responsibility to prescribe a chair equipped with equipment necessary to relieve the support points, such as a pressure-relief cushion.

 **CAUTION:** After use, always re-tension the seating pad upholstery.

### 3.6) General safety rules

Always lock the brakes when the user goes into or out from the chair.

 **Never go onto an escalator.**  
**Do not smoke when sitting in the chair.**

### 3.7) Precautions relative to electromagnetic compatibility

The seat was designed to meet the international electromagnetic compatibility requirements. However, appliances producing significant electromagnetic fields

may affect the seat behaviour. Should the case arise, please contact the distributor.

- The presence of long distance transmitters and receivers, such as diffusion transmitters (TV and radio antenna towers), amateur radio stations and other devices may lead to malfunctioning. In case of doubt, do not use the electric shell seat anymore until the problem is solved.

- Using the electric shell seat may lead to malfunctioning of some sensitive equipment. In case of doubt, do not use the shell seat anymore until the problem is solved.

## IV - DELIVERY AND COMMISSIONING

The chair is delivered according to the prescription sheet. Any modification totally binds the healthcare professional.

All Drive DeVilbiss Healthcare France chairs are controlled in our factory and specially packaged for transport.

Before unpacking the chair, check the box has not been damaged, then make sure all the accessories and options are present, including the use instructions and the service warranty book. The accompanying documentation should imperatively be given to the user so as he/she understands the chair use and warranty conditions. After commissioning the chair, the healthcare professional or an authorised person will perform the adjustments specific to the user. It is the professional's responsibility to give the security and use instructions to the user, as well as the warnings described in this manual. The professional should also make sure the user understood these instructions.

The packaging boxes and the different protective elements of the chair should be sent to an approved waste treatment centre.

## V - USE RECOMMENDATIONS

This chapter describes some techniques to optimally use the chair. Moreover, these techniques may be useful to overcome everyday-life obstacles.

General and hygiene recommendations: The chair should be regularly cleaned according to the recommendations described in the following pages, and it should never be used if there any doubt about its proper performance.

### 5.1) Seat belt

When the user has difficulties to be seating or may lose his/her balance, the seat belt should be used. A healthcare professional should install and adjust the seat belt. It is important not to tighten too much the belt and to adjust it according to the circumstances.

The belt fastens in front by fitting it tightly around the patient. The seat belt is adjusted by adjusting the strap length thanks to a loop; opening and closing are possible thanks to two buckles (male and female), one of which has a locking system.

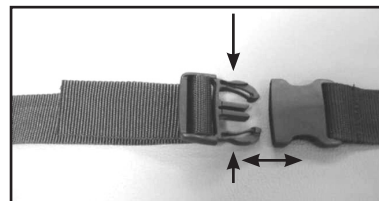

*Note: there is also an optional harness which harmonizes with the seat belt.*

# USER AND MAINTENANCE MANUAL FOR *Integra et Selectis* SHELL SEATS

The first time you use the seat belt:

- Standing position transfer seat: The belt is under the wooden seating plate. To release it, tilt the transfer seat to the maximum (see 10.6), pull the ends to remove the staples, fold the straps of the belt on the patient side, and lower the transfer seat.
- Standard seat: The belt is under the seating pad. To release it, remove the seating pad, release the belt, and put back the seating pad.

**⚠ Do not fasten the seatbelt of the patient when using the Transfer in standing position function.**

## 5.2) For maximum stability

The chairs *Integra* and *Selectis* was designed to be stable during normal daily activities, provided the user's centre of gravity (the body weight) is not moved to the outside of the surface delimited by the four support points of the wheels on the ground. Thus, the user should always manage the chair balance to maximise its stability and handling.

When the user has activities where he/she needs moving the body, it is recommended to use posture straps or a seat belt.

When moving, the shell should be in a position slightly tilted backwards.

## 5.3) Driving indoors

The chair can be moved when the patient is sitting in, provided that the ground condition is taken into account (doorstep, lift...).

**⚠ CAUTION:** Never use the chair in a slope (whatever the angle is).

## 5.4) Clearing an obstacle

**⚠ CAUTION:** Never clear an obstacle whose height is higher than 2 cm (doorstep) when the patient is sitting in the chair.

## 5.5) Leaning forward (stationary chair)

Here, we are in the static stability configuration. To lean forward, make sure the brakes are locked. Do not adopt an extreme position; the buttock should stay lying on the seat. Do not lean on the footrests, as there is a tipping risk.

## 5.6) Leaning backward (stationary chair)

The back of the chair should be as close as possible from the object to grab.

Avoid leaning backward too much; make sure the buttock stays lying on the seat. Do not lock the brakes, as it is preferable to reverse rather than tip over.

**⚠ CAUTION:** Never exceed the chair stability limit. Never perform these manoeuvres near stairs or obstacles that could make the chair unstable.

## 5.7) Transferring

Transferring is only possible forwards.

After applying the brakes onto the wheels, tilt the shell forwards.



Shell in maximum forward position

Legrest maximally retracted under the seat.

The user may get up from the seat, with the help from an accompanying person or not, but always in presence of somebody. The reverse procedure should be respected to install the patient into the shell seat.

NB: if the chair is equipped with the transfer aid feature (M.T. and E.T.), see Chapter 10.7

**⚠ CAUTION:** Adapt the shell floor/seat height according to the patient's height (see paragraphs 10.1).

The footrest plate (option) should directly touch the floor when the chair is in trendelenburg position. Totally remove the footrest plate (see paragraph 10-9) if it bothers the patient's transfer (small patient).

## VI - REGULAR MAINTENANCE

### 6.1) Use and storage conditions

	Mini. temperature	Maxi. temperature	Mini. humidity	Mini. humidity
Use	0°C	+40°C	20%	90%
Storage	-10°C	+50°C	20%	90%

### 6.2) Regular maintenance

**UPHOLSTERY:** Check the tension and general condition of the upholstery and existing pads. They should not be undone, torn, or not attached correctly.

**BOLTING:** All the tightening should be sufficient, but not excessive not to damage the tubes or block the moving parts. Never use a chair whose fastening is loose.

**CASTERS:** regularly check the condition of the 4 casters, their wear and the performance of their braking system.

**FOOTREST AND LEGREST:** Check the legrest and the footrest (option) are strongly fixed onto the chair.

### 6.3) Cleaning

Before cleaning the chair, disconnect the power supply cord. Clean the frame as often as necessary with a slightly dampened sponge.

The materials used for upholstery are resistant to most everyday environmental factors. They meet D60-070 standard relative to household, food, and pharmaceutical products. They remain soft and keep their original splendour if they are regularly maintained (at least once a month).



to do it :

- Regularly dust and clean.
- Use soapy water, and then rinse with clean water, but not excessively.
- Remove all the stains as fast as possible.
- Regularly remove the sweat marks.
- Avoid prolonged exposure to any heat source.
- Do not use undiluted alcohol, solvents, detergents, corrosive cleaning products, perchlorethylene, waxes, trichlorethylene.
- To remove or reduce any stubborn stain, use bleach or 10% alcohol diluted in water, and then rinse with clean water, but not excessively.

Some stains can be reduced, though not removed, after cleaning, such as for example, ink, some medical products, coffee, wine, alcohol, urine, blood, food, chocolate, ketchup, etc., and some colorants used for clothes such as jeans. The colorants of those materials migrate into the fabric mass, and then it is impossible to totally remove them. Drive deVilbiss healthcare France is not liable for residual stains resulting from outside pollutants.

## VII - MAINTENANCE

Regular revisions are necessary for the chair works properly, and for the user's security. The time period between two revisions depends on the use conditions, but should never exceed one year. If the chair is intensively used, it is then necessary to revise it much more frequently.

Frequently lubricate the hinge pins to avoid any mechanical noise.

### 7.1) Disinfecting

If necessary or in case the user is not the same, it may be necessary to disinfect the chair.

Disinfecting is performed with detergents and disinfecting solutions sprayed on the external chair areas. It is a foaming solution that does not require rinsing, but only drying. There are different providers. Our internal services use ANIOS solutions.

## VIII - YEARLY MAINTENANCE, REPAIRING, WARRANTY

Maintenance and repair procedures do not require any particular tool. These procedures should be performed by skilled staff. There is no particular process to perform, the good engineering practice applies.

Only the original parts provided by Drive DeVilbiss Healthcare France can be used to repair a Drive DeVilbiss Healthcare France chair. Any change or repair performed with parts coming from another source cancels the warranty; Drive DeVilbiss Healthcare France disclaims any liability in case of injury or accident.

The user must have the chair controlled, at least once a year, by an approved engineering centre.

### 8.1) Main procedures

- Check all the fastenings and hinge pins with systematic replacement of the loosened nylostop nuts and worn screws (damaged thread, reduced screw section, and rust traces).
- Lubricate the hinge pins.

- Control of all welding, and systematic replacement of the parts, whose welding has cracks, come off, tear off, the twisted, out-of-shape, or buckled parts should systematically be replaced. If some paint comes off or flakes away near a welding, this may mean the welding has a defect or begins to break. Go into detail with this control when the chair is in a bad general condition or when the treads have chock signs or deep cuts.

- Inspection of the wheels equipped with brakes and systematic replacement if their performance is uncertain.

- Check of the locking and adjusting systems; systematic replacement if they do not work properly and if there is a risk for the user's or the accompanying person's security.

- Check the axial and radial play of the wheel pivot is minimum and there is no abnormal noise when they are rotating.

- Inspection of the wheel tyre treads with systematic replacement if they are cut, cracked, torn, crackled or too worn (flat on the outside).

- Control of the upholstery, with systematic replacement if the sewing is undone, if the cloth is torn, cut, with holes or worn.

- Check of the footrest plate (option) with systematic replacement if it is bent.

After these controls and adjustments, check the chair and its accessories functionality (if applicable): wheel rotation, braking, rolling, shell angle, and chair stability.

If the chair is equipped with an electric cylinder, check this latter properly works.

 **CAUTION:** Carefully check the power supply cord, the supply box, and the remote control. Any sign of wear and tear, cut or gash should lead to a systematic replacement.

For any additional information, please contact your Customer Service or your distributor.

Any procedure should be registered in the chair service warranty book.

### 8.2) Accessories

Only use accessories exclusively provided by Drive DeVilbiss Healthcare France and compatible with the chair.

### 8.3) Storage

Before storing the chair for a long period, clean it totally, and check its performance. Store it in a dry place, away from dust and humidity. When commissioning, after storing, check its performance before any use.

### 8.4) Chair service life and end of life

The chair service life is 5 years, provided the guidance and use conditions are met, and the chair is maintained at least once a year, as indicated.

Do not dispose of the chair or its accessories when they cannot be used anymore. Send them to an approved waste treatment centre.

# USER AND MAINTENANCE MANUAL FOR *Integra et Selectis* SHELL SEATS

## 8.5) Warranty conditions

Two-year warranty on the mechanical structure. This warranty corresponds to normal use of the chair, and excludes any damage due to incorrect use or maintenance. The warranty does not apply to the repaired or changed material without the manufacturer's agreement. The warranty does not cover normal wear of materials and parts. In case of return, the final provider pays packaging and freight charges. In no case our warranty shall give rise to direct or indirect damages.

This Drive DeVilbiss Healthcare France equipment (with warranty in the above-mentioned conditions) met the tests our technical services performed and meets the established official specifications.

A service warranty book is provided with every chair. It should be maintained and completed during every procedure.

## IX - OPTIONS AND TECHNICAL INFORMATION

### 9.1) General presentation

- **Integra** : E-125-mm four-wheel telescopic leg.
- **Selectis** : VHP wheelbase.
- M4 non-inflammable class coloured PVC upholstery, with a storage bag.
- Shell angle: from -3° (forward) to +26° (backward)
- **Integra** and **Selectis** are available in 4 versions:
  - M type**: Manual inclination of the shell, aided with blocking. Automatic inclination legrest.
  - M.T. type**: Manual inclination of the shell, aided with blocking. Electric transfer seat with remote control. Automatic inclination legrest.
  - E.T. type**: Electric inclination of the shell and transfer seat with remote control. Automatic inclination legrest.
- POSTURE**: Manual inclination of the shell and legrest, independent, aided with blocking.

- Push-bar.
- Two-points lap belt.

### 9.2) General terminology and technical specifications

- 1 - E-125-mm four-caster telescopic leg (INTEGRA)
- 2 - VHP wheelbase (SELECTIS)
- 3 - Push-handle
- 4 - Remote control (M.T. and E.T. versions)
- 5 - Armrests
- 6 - Standard headrest pad
- 7 - Backrest
- 8 - Seating pad
- 9 - Legrest
- 10 - Legrest system
- 11 - E-125-mm casters equipped with brakes (x3) + 1 directional caster + 1 roller (INTEGRA)  
Two 12,5"-tyre rear wheels and two 6"-front wheels (SELECTIS)
- 12 - Mains power supply (types M.T. and E.T.)



# USER AND MAINTENANCE MANUAL FOR *Integra et Selectis* SHELL SEATS

Sizes	Seat width	Overall width (without shelf)	
		Integra	Selectis
* Type MT and ET: only those 3 sizes		Integra	Selectis
T 39*	390	670	700
T 42	420	670	700
T 45*	450	670	700
T 48	480	720	700
T 51*	510	720	700

## Power requirements (if applicable)

Mains power supply:

- Mains 100-240V AC 50-60Hz 1.2A
- Continuous 24V, 2A output
- Duty cycle: max 10%, Max T\_ON: 2 min
- Class II

All the dimensions are in mm: +/- 10 mm - +/- 1°

EC marking date: 2013

Shell angle	Maximum user weight	Chair weight	Seat depth	Seat height with 7-cm pad		Armrest height	Overall length (without footrest)	Maximum permissible slope
				Type M	Types MT et ET			
Type M, MT et ET -3° / +27° <small>not including the only seat inclination on types MT and ET</small>	120 kg	from de 25 kg	Type M 410 440 470	Type M 450 (posi. 1) 490 (posi. 2) 530 (posi. 3)	Types MT et ET 480 (posi. 1) 520 (posi. 2) 560 (posi. 3)	Types M et POSTURE 230	Integra 780	2°
Type POSTURE -6° / + 27°			Types MT, ET & POSTURE 440  <small>depending on the patient's height selected on the dimension sheet</small>	Type POSTURE 490 (posi. 2) 530 (posi. 3) (posi. 1 incompatible)  <small>Preset depending on the patient's height selected on the dimension sheet and modifiable by the distributor if necessary</small>	Types MT & ET 200	Selectis 890		

## 9.3) Options



Side shelf



Lap shelf

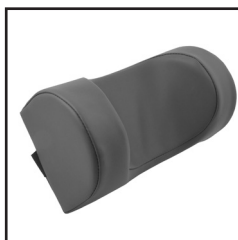

Ergonomic headrest



Viscoelastic foam seating pad



3-point pelvic belt



Battery power supply  
(for M.T. and E.T.)



3-point harness  
(only on M version)



Footrest plate  
(only for version M.  
& POSTURE)



Serial standard knee  
positioning cushion



## X - ASSEMBLY AND ADJUSTMENTS

Necessary tools to adjust the seat:

- 1 set of hexagonal keys
- 1 10mm spanner
- 2 13mm spanners
- 1 small flat-head screwdriver
- Power drill with D 48-mm drill
- Riveter

### 10.1) Seat height

You can directly adjust the floor/seat height onto the telescopic leg.

- Unscrew the nuts and remove the screws (**C** and **D**) with 2 13-mm spanners.
- Slide the runner (**A**) into the leg (**B**) up to the corresponding hole at the desired height, and put back the screws.
- Moderately screw back the nuts.

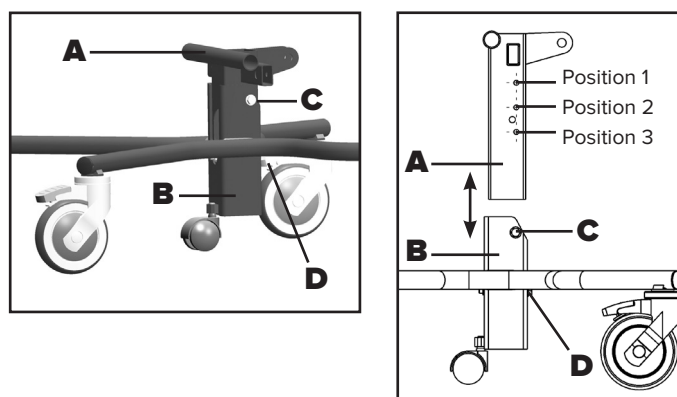

For the different positions, see the values in the table page 8. The height adjustment procedure is the same as with Selectis.

**!** Position 1 incompatible with **POSTURE** model.

### 10.2) Standard or ergonomic headrest



The height of the headrest (●) easily adjusts, thanks to the support elastic strap (M).

### 10.3) Side shelf



The shelf simply clips onto the side handle (right or left).

**!** Remove the shelf every time you want to move with the chair.

**!** **CAUTION:** Do not use the shelf edges to straighten the chair.

### 10.4) Seating pad

The standard seating pad is detachable, and can be replaced by a pressure-relief cushion prescribed by a specialist, and compatible with *Integra* and *Selectis* chair seat size, and provided by Drive DeVilbiss Healthcare France.

### 10.5) Shell tilting

M., M.T. and POSTURE versions, assisted inclination:

Sitting in the chair, the accompanying person tilts the shell by engaging the trigger on the push handle.



Version E.T., inclinaison électrique par télécommande :

The user or the accompanying person tilts the shell with the remote control.



**CAUTION:** When installing and using the chair, check the power supply cord is not trapped by the mechanism, or by the wheels. Always unplug the power supply cord when the chair is not used.



Never sit on the legrest or the backrest. Check no obstacle or object can impede the chair manoeuvres.

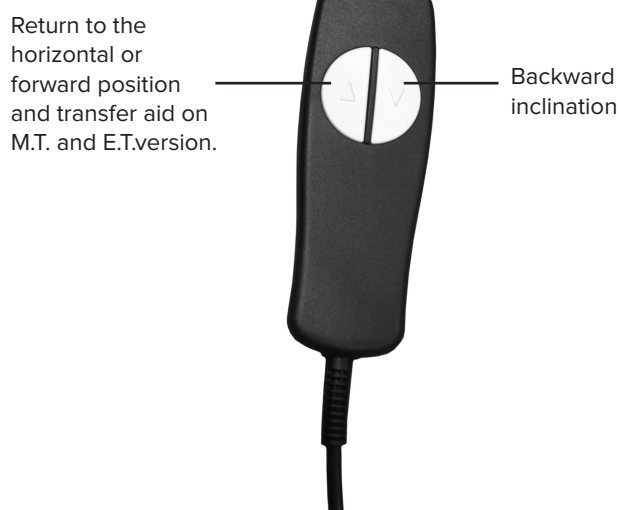

# USER AND MAINTENANCE MANUAL FOR *Integra et Selectis* SHELL SEATS

## 10.6) Legrest inclination

### *M., M.T., and E.T. versions, legrest with automatic inclination*

The seat is equipped with an automatic inclination legrest, whose angle varies depending on the shell inclination



### *POSTURE version, independent manual inclination legrest*

The seat is equipped with a legrest, whose inclination is manual, assisted, adjustable, and lockable in a position that is independent of the shell inclination.

The caregiver tilts the legrest thanks to a release lever located at the front left of the chair, under the seat.

To change the inclination angle of the legrest, the caregiver:

- Stands at the front left of the chair, facing the release lever,
- Bends and moves into squat position,
- Pushes with his/her right hand on the release lever following the legrest plane and downward.

Pushing on the lever will release the legrest.

● Takes with his/her left hand the legrest, handles it, and positions it to the desired angle,

● Releases the lever to lock the legrest at the desired angle.



## 10.7) Transfer aid

(only on M.T. and E.T. versions)

*Integra* and *Selectis* shell seats are equipped with the transfer aid feature, allowing the patient to stand up from the chair almost effortlessly.

**CAUTION:** It is not recommended to use the safety belt. However, if it is necessary, make sure to remove it before using the transfer aid.

With the remote control, it is possible to tilt the chair backwards and forwards, but it is also possible to lift the seat back for easier transfer.

### Standing up

After checking the brakes are engaged, straighten up the chair with the remote control until the seat is in horizontal position. While still pressing the remote control button, firmly hold the armrest front part, rest your feet on the floor, and while the seat is rising, slightly lean forward.

When the seat stops rising, leave the chair.

### To sit down

After checking the brakes are engaged, straighten up the chair with the remote control until the seat is in horizontal position. While still pressing the remote control button, firmly hold the armrest front part, rest your feet on the floor, and while the seat is rising, slightly lean forward.

When the seat stops rising, leave the chair.

**CAUTION:** The transfer aid only works when the chair is maximally tilted forwards (see photo on 5.7).

**CAUTION:** Make sure the brakes are engaged when sitting down in the chair and when leaving the chair.

**CAUTION:** Make sure the patient is strong enough to carry out the manoeuvre alone, without anybody helping him/her. Do not put any object under the seat when it is lifted up. Never put your fingers or hands under the seat when the chair is moving.



## 10.8) Footrest plate adjustment (option)

Only on M and POSTURE versions. Incompatible with M.T. and E.T. versions.

- Remove both clips (A).
- Adjust the footrest plate height. In forward position, it should touch the floor.
- Put the clips (A) back.

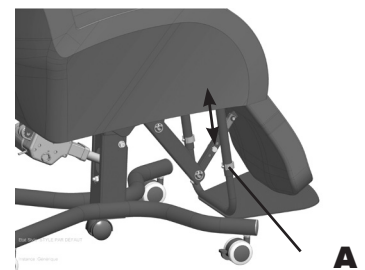

**CAUTION:** if the plate does not touch the floor, there is a tipping risk. Never stand up onto the plate when it does not touch the floor.

# USER AND MAINTENANCE MANUAL FOR *Integra et Selectis* SHELL SEATS

## 10.9) -point pelvic belt and harness (option)

 Remove the safety belt before using the transfer aid feature (on M.T. & E.T. versions).

 **CAUTION:** make sure you properly adjust the belt so that there is no strangulation risk.

## 10.10) Braking of the wheelbase (only on SELECTIS)

To apply the brake on the rear wheels, place yourself at the rear of the chair, and then press the central pedal with your foot.

To disengage the wheels, lift up the central pedal with the top of your foot, or place yourself on one of the chair sides and press the side pedal with your foot.

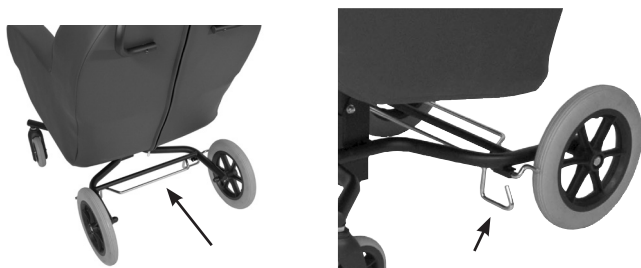

## 10.11) Braking the institution leg and directional wheel (only on INTEGRA)

To engage or disengage the brakes, press all the black pedals with your foot.

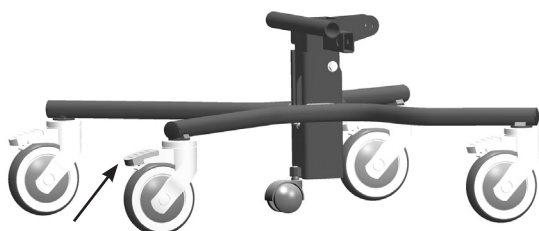

## 10.12) Lap shelf (optional)

Assembling the optional lap shelf:

Tools: a 5-mm hexagonal key and a 13-mm spanner

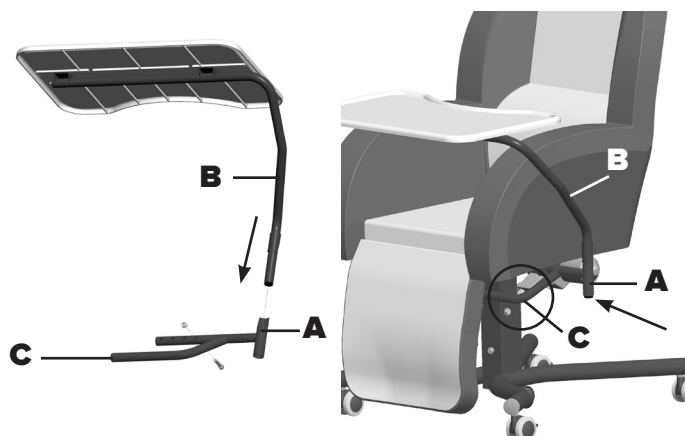

Insert the **A** shelf support into the sleeve located under the seat, the tube **C** has to be in support on the foot, position the mounting hole in front of the hole adapted to the chair dimensions. Then, tighten the screw and its nut to fix the assembly.

Join the **B** shelf arm in the **A** shelf support. Thus, the shelf can be positioned in position of use or retracted on the side.

 Remove the shelf every time you want to move with the chair.

## 10.13) Battery operation (option)

Depending on the model, the chairs may be equipped with a lithium-ion battery (photo n°1) to work in standalone mode, that is to say without being connected to any outlet. The battery may also be used as an emergency source of power in case of power outage.

Photo N° 1



The battery can be fixed under the chair (photo n°2) or can be simply placed on the floor, near the power supply (photo n°3). The chair power supply is used as a battery charger. It is not necessary to buy another charger.

Photo N° 2



Photo N° 3



# USER AND MAINTENANCE MANUAL FOR *Integra et Selectis* SHELL SEATS

## 10.13.a First use



### **CAUTION** Carefully read the following instructions:

- Before plugging in the battery, connect it to the power supply, and then connect the power supply to the outlet. To unplug the battery, remove first the power supply from the outlet, and then unplug the battery from the power supply.
- Totally charge the battery before the first use.
- Do not link together the battery connectors.
- If the chair is not used for a long time, charge the battery once a month at least.
- Charge the battery every night.
- Depending on the operation mode, the battery can remain permanently plugged to the power supply.
- The battery charging time is 5 hours, but 8 hours are recommended.
- The battery should be used or stocked in a dry and well-ventilated place.
- Do not cover the battery, do not put it within a box or in a bag, do not place it in a wet place, or if there is a splash water hazard.
- Immediately unplug the battery if it produces smoke, if it produces any odour or in case of whistling.

When the new battery is totally charged, you can realise manoeuvres with a patient weighing 120 kg. The number of manoeuvres decreases over time as the battery loses its capacity (80% of the name plate capacity after 300 cycles). Replace the battery when its capacity is no longer sufficient for the intended use.

If the battery does not work properly, it is possible to quickly and simply come back to the power supply mode, you just have to unplug the battery and to directly link the power supply to the chair power cord (photo n°4).

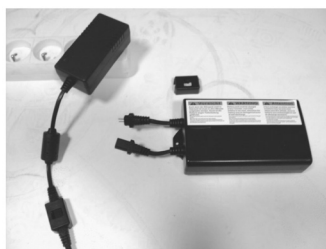

Photo N° 4

## 10.13.b Precautions

- Regularly check the condition of the battery and cables. In case of doubt, immediately unplug the battery.
- Very regularly check the box and cables do not have defect such as cut, crack, distortion due to heat and burn sign.
- Do not dispose of a defective battery like household waste, but give it to an approved waste treatment centre.
- Only replace the battery and electrical cables with components provided by Dupont Médical.
- Do not use the battery for any other application.
- The battery switches in self-protection mode for a few seconds in case of overload or in case of too strong discharge.

- Absolutely do not expose the battery to any heat source such as a heater, or even to sunlight through a window.
- To replace the battery mounted on the chair, tilt the chair forward, disconnect the battery connectors from the battery, and then unscrew both screws with a 8-mm socket wrench. To put the battery together, repeat the same operations in the opposite way (moderately tighten the screws).

## 10.13.c Use

Connect the battery to the power supply, and then connect the power supply to the outlet.

The indicator blinks red when the battery is charging, and then blinks green when the battery is charged. The indicator is OFF when the battery is in use.

The battery beeps when the charge is too low. It should then be recharged.

When the indicator is constantly lit red or if it alternatively blinks red and green, change the battery.

## 10.13.d Specifications

Name plate capacity	2,300 mAh
Minimal capacity	1,800 mAh
Nominal voltage	25.2 V
Charging voltage	24 V-32 VDC
Output current	<5 A DC
Stop current	10 A
Low battery beep	23 VDC
Humidity	20-80%
Charging temperature	0°C to 40°C
Service temperature	-15°C to 50°C
Storage temperature	-15°C to 40°C

Cachet

 **Drive DeVilbiss Healthcare France**

Chaussée du Ban la Dame - Parc d'activités Eiffel Energie  
ZAC du Ban la Dame - BP 19 - 54390 FROUARD - FRANCE  
Tél. 03 83 495 495 - Fax 03 83 495 496