

KERN[®]

KERN & Sohn GmbH

Ziegelei 1
D-72336 Balingen
E-Mail: info@kern-sohn.com

Tel: +49-[0]7433- 9933-0
Fax: +49-[0]7433-9933-149
Internet: www.kern-sohn.com

Operating Manual

Personal balance without / with stand

KERN MPB

Version 1.5
07/2017
GB



MPB-BAPS-e-1715



KERN MPB

Version 1.5 07/2017

Operating Manual

Personal balance, personal balance with stand,

Table of Contents

| | | |
|----------|--|-----------|
| 1 | Technical Data | 4 |
| 2 | Basic Information (General) | 5 |
| 2.1 | Proper use | 5 |
| 2.2 | Improper Use | 5 |
| 2.3 | Warranty | 5 |
| 2.4 | Monitoring of Test Resources | 6 |
| 3 | Basic Safety Precautions | 7 |
| 3.1 | Pay attention to the instructions in the Operation Manual | 7 |
| 3.2 | Personnel training | 7 |
| 4 | Transportation & Storage | 7 |
| 4.1 | Testing upon acceptance | 7 |
| 4.2 | Packaging | 7 |
| 5 | Unpacking, Setup and Commissioning | 8 |
| 5.1 | Installation Site, Location of Use | 8 |
| 5.2 | Unpacking..... | 9 |
| 5.2.1 | Balance assembly and installation | 9 |
| 5.2.2 | Scope of delivery | 11 |
| 5.2.3 | Assembly instructions for models with wall fixing device | 11 |
| 5.3 | Mains connection..... | 12 |
| 5.4 | Battery operation (insertion and removal) | 12 |
| 5.5 | Initial Commissioning | 12 |
| 5.6 | Adjustment (only dealers authorised by KERN) | 12 |
| 5.6.1 | Procedure when adjusting (only dealers authorised by KERN) | 13 |
| 5.7 | Menu overview (only dealers authorised by KERN) | 15 |
| 6 | Operation | 17 |
| 6.1 | Controls 4-button terminal..... | 17 |
| 6.1.1 | Display | 17 |
| 6.1.2 | Keyboard overview | 18 |
| 7 | Using the balance | 19 |
| 7.1 | Weighing..... | 19 |
| 7.2 | Taring | 19 |
| 7.3 | Hold function (Standstill function)..... | 20 |
| 7.4 | Calculation of the Body Mass Index | 20 |
| 7.4.1 | Classification of BMI values | 21 |

English

| | | |
|-----------|---|-----------|
| 8 | Error message | 22 |
| 9 | Service, maintenance, disposal | 22 |
| 9.1 | Cleaning | 22 |
| 9.2 | Service, maintenance | 22 |
| 9.3 | Disposal..... | 22 |
| 10 | Instant help | 23 |
| 11 | Declaration of Conformity | 24 |

1 Technical Data

| KERN | MPB300K100 / P |
|---|--|
| Readability (d) | 100 g |
| Weighing range (max) | 300 kg |
| Recommended adjustment weight, (Class) | 200 kg (M2) |
| Stabilization time (typical) | 2 – 3 sec. |
| Warm-up time | 10 min |
| Electric Supply | Mains adapter 9V / 100 mA |
| | Battery operation 6 x 1.5V, size AA Service life 170h |
| Auto Off | After 3 min without load change (adjustable) |
| Operating temperature | + 5°C ... + 35°C |
| Storage temperature | - 20°C ... + 60°C |
| Humidity of air | max. 80 % (not condensing) |
| Platform (B x D x H) mm | 315x300x60 |
| Terminal (B x T x H) mm | 210 x 110 x 48 |
| Balance ready for operation (B x D x H) mm | Without stand: 315x300x60 with stand: 315x440x1010 |
| Weight kg (net) | Without stand: 4.0 with stand : 5.8 |

2 Basic Information (General)

2.1 Proper use

This balance is used to calculate the weight of people in the private sphere. Utilisation of this balance in the medical field is not permissible.

A person must stand on the weighing plate for the weighing procedure. As soon as a stable weighing value is reached the weighing value can be read.

When using balance with height measurement, ensure that the top flap is turned downwards immediately after use in order to avoid risk of injury.

The balance should be checked for correct condition prior to each utilisation by a person familiar with proper operation of the balance.

2.2 Improper Use

Do not use balance for dynamic weighings. In the event that small quantities are removed or added to the material to be weighed, incorrect weighing results can be displayed due to the "stability compensation" in the balance. (Example: Slowly draining fluids from a container on the balance.)

Do not leave permanent load on the weighing plate. This may damage the measuring system.

Impacts and overloading exceeding the stated maximum load (max) of the balance, minus a possibly existing tare load, must be strictly avoided. This could cause damage to the balance.

Never operate balance in explosive environment. The serial version is not explosion protected.

The structure of the balance may not be modified. This may lead to incorrect weighing results, safety-related faults and destruction of the balance.

The balance may only be used according to the described conditions. Other areas of use must be released by KERN in writing.

2.3 Warranty

Warranty claims shall be voided in case

- Our conditions in the operation manual are ignored
- The appliance is used outside the described uses
- The appliance is modified or opened
- mechanical damage and damage caused by media, liquids
- natural wear and tear
- The appliance is improperly set up or incorrectly electrically connected
- The measuring system is overloaded
- Dropping the balance

2.4 Monitoring of Test Resources

In the framework of quality assurance the measuring-related properties of the balance and, if applicable, the testing weight, must be checked regularly. The responsible user must define a suitable interval as well as type and scope of this test. Information is available on KERN's home page (www.kern-sohn.com) with regard to the monitoring of balance test substances and the test weights required for this. In KERN's accredited DKD calibration laboratory test weights and balances may be calibrated (return to the national standard) fast and at moderate cost.

Using measuring technology to check the accuracy of the measuring device is recommended for personal balances with body height measurement but is not absolutely essential as the calculation of the human body height is always subject to a great deal of inaccuracy.

3 Basic Safety Precautions

3.1 Pay attention to the instructions in the Operation Manual

Carefully read this operation manual before setup and commissioning, even if you are already familiar with KERN balances.

3.2 Personnel training

The appliance may only be operated and maintained by trained personnel.

4 Transportation & Storage

4.1 Testing upon acceptance

When receiving the appliance, please check packaging immediately, and the appliance itself when unpacking for possible visible damage.

4.2 Packaging

Keep all parts of the original packaging in case you need to return the appliance.

Only use original packaging for returning.

Before sending, disconnect all connected cables and loose/movable parts.

Attach possibly existing transport safeguards. Secure all parts e.g. weighing platform, power pack, stand, operating panel etc. against slipping and damage.

5 Unpacking, Setup and Commissioning

5.1 Installation Site, Location of Use

The balances are designed in a way that reliable weighing results are achieved in common conditions of use.

You will work accurately and fast, if you select the right location for your balance.

Therefore, observe the following for the installation site:

- Place the balance on a firm, level surface;
- Avoid extreme heat as well as temperature fluctuation caused by installing next to a radiator or in the direct sunlight;

- Protect the balance against direct draughts due to open windows and doors;
- Avoid jarring during weighing;
- Protect the balance against high humidity, vapors and dust;
- Do not expose the device to extreme dampness for longer periods of time.
Non-permitted condensation (condensation of air humidity on the appliance) may occur if a cold appliance is taken to a considerably warmer environment. In this case, acclimatize the disconnected appliance for ca. 2 hours at room temperature.
- Avoid static charge of the balance and of the person to be weighed.
- Avoid contact with water.

If electro-magnetic fields or static charge occur, or if the power supply is unstable major deviations on the display (incorrect weighing results) are possible. In that case, the location must be changed.

5.2 Unpacking

Remove the individual components of the balance or the complete balance from the packaging with care and install at the intended location. When using the power pack, ensure that the power cable does not produce a risk of stumbling.

5.2.1 Balance assembly and installation

MPB personal balance with wall fixing device:

Scope of delivery:



MPB personal balance with stand:



Instructions for attaching an optimum body-height measuring device to the model MPB with stand

A separately available body-height measuring device can be screwed onto this model. Follow the operating instructions for the body-height measuring device for this purpose.

Instructions for attaching an external stand to Model MPB without stand and.



English

- Secure wall fixing device with screws at the top on the aluminium section
- Secure circular plate with screws on the aluminium section
- Remove the two lateral rubber plugs from the display unit.
- Secure the display unit with the two rotary knobs to the fixing device.
- Position display unit with the rotary knobs.
- Secure cable with cable clips

General instructions for installing the aforementioned balance.

Install the personal balance in the intended location exactly horizontally.

5.2.2 Scope of delivery

Serial accessories:

- *Mains power supply*
- *Operating Manual*

5.2.3 Assembly instructions for models with wall fixing device

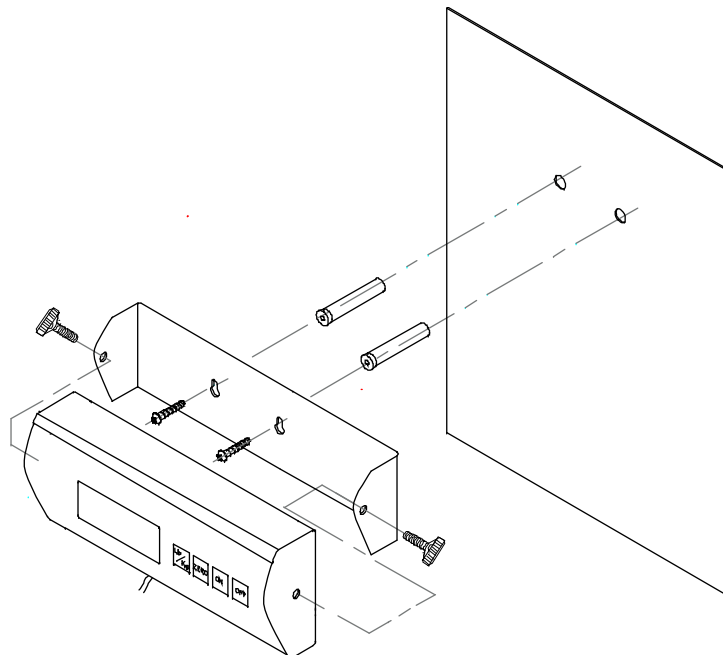

5.3 Mains connection

Power is supplied via the external mains adapter. The stated voltage value must be the same as the local voltage. Only KERN original power packs should be used.

5.4 Battery operation (insertion and removal)

On models where the back of the display unit is not directly accessible, remove the two black rotary knobs from both sides of the display unit in order to open the battery compartment and remove the display unit from the holder. Remove battery cover from under the display unit. Insert 6 x 1.5V AA batteries into the holder. Replace battery cover and screw the display unit back into the holder using the black rotary knobs.

In order to save the battery, the balance switches automatically off after 3 minutes without weighing. Further shutdown times can be set in the Menu (Function "A.OFF"), see chapter 5.7.

If the batteries are run down, "LO" appears in the display. Press **[ON/OFF]** -key and replace the batteries immediately.

If the balance is not used for a longer time, take out the batteries and store them separately. Leaking battery liquid could damage the balance.

5.5 Initial Commissioning

In order to obtain exact results with the electronic balances, your balance must have reached the operating temperature (see warming up time chap. 1). During this warming up time the balance must be connected to the power supply (mains, accumulator or battery) and be switched on.

The accuracy of the balance depends on the local acceleration of gravity.









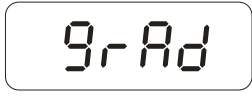

5.6 Adjustment (only dealers authorised by KERN)

As the acceleration value due to gravity is not the same at every location on earth, each balance must be coordinated - in compliance with the underlying physical weighing principle - to the existing acceleration due to gravity at its place of location (only if the balance has not already been adjusted to the location in the factory). This adjustment process must be carried out during the initial start-up, after change in location and variation of surrounding temperature. To receive accurate measuring values it is also recommended to adjust the balance periodically in weighing operation.

Use the adjustment weight (See Technical Data) to check and adjust the accuracy of the balance at any time.

5.6.1 Procedure when adjusting (only dealers authorised by KERN)

Observe stable environmental conditions. A warming up time (see chapter 1) is required for stabilization.

| Operation | Display |
|--|---|
| Turn on balance by pressing the [ON/OFF] key |  |
| Keep [→0←] button depressed for approx. 3 sec until "SETUP" is displayed followed by "9rAd" |  ↓  |
| Press the [TARE] button as often as required until "CAL ib" is displayed |  |
| Press the [HOLD] button. |  |
| Press the [TARE] key. (Zero count mode) |  |
| Press the [→0←] button repeatedly until "CAL 0" is displayed. |  |
| Press the [HOLD] button. |  |
| Press the [TARE] key. Enter the required size of the adjustment weight (See Section 1, "Technical Data"): Press the [HOLD] button to select the item to be changed and press the [TARE] button to select the numerical value. |  |
| Confirm by pressing the [→0←] button. |  |

Place the adjustment weight carefully in the centre of the weighing plate and a numerical value will appear in the display. Press the **[HOLD]** button. The adjustment process is started.



82077

The balance will automatically return to Weighing mode upon successful completion of the adjustment and will display the weight of the adjustment weight. Take away adjustment weight.



200.0

Turn off balance by pressing the **[ON/OFF]** key.

5.7 Menu overview (only dealers authorised by KERN)

Navigation in the menu:

- With the balance switched on, keep the [→0←] button depressed for approx. 3 sec until "SETUP" is displayed followed by "9rAd".
- Press the [TARE] button as often as necessary until the required function is displayed.
- Press the [HOLD] button to confirm the selected function. The first parameter will be displayed. Press the [HOLD] button to select the required parameter and confirm by pressing the [TARE] button.

To exit the Menu and save, press the [TARE] button as often as required until "End" is displayed and then confirm by pressing the [HOLD] button. The balance returns automatically into weighing mode.

Select using the [HOLD] → and the [TARE]-button



| Function | Settings | Description |
|---------------|--|---|
| Grad | 3000 d – 6000 d – 10000 d – 500 d – 1000 d – 1500 d - 2500 d - 2000 d | The values of the scale elementary division, weighing range (max) and elementary division (d) |
| Ut.-d | Full – S-Ut | Selection: one-range scales (Full)- / multi-range scales (S-Ut) |
| Auto 0 | 0.25 d – 0.5 d – 1 d – 3 d - OFF | Auto-Zero-Tracking |
| Stab | 0.25 d – 0.5 d – 1 d – 3 d - off | Stabilisation range |
| Orang | 2 Pct – 100 Pct. | Zero range: 2 % / 100 % |
| Ould | 9 d – 2 Pct. | Overload range: 9 d / 2 % |
| CALib | CAL-U – CAL-0 CAL-5 | Adjustment |
| A.Off | 120s/180s/240s/ 300s/off | Auto off |

| | | |
|--------------|--|-------------------------------|
| burr | on/off | Acoustic signal |
| defle | no - yes | Resetting to factory settings |
| End | Leaving the menu after pressing  button | |

Description (only dealers authorised by KERN):

| | |
|--------------|--|
| grAd | Partition steps, weighing range (max.) and readout (d) |
| BL-d | Multi-range balance/ single-range balance selection |
| FuLL | Single-range balance |
| S-BL | Multi-range balance |
| Auto0 | Auto Zero Tracking: 0.25d/ 0.5d/ 1d/ 3d/ OFF |
| StAb | Stabilisation range: 0.25d/ 0.5d/ 1d/ 3d/ OFF |
| OrAng | Zero range: 2% / 100% |
| Overd | Overload range: 9d / 2% |
| CALib | Adjustment |
| ROFF | Auto off: 120 sec/ 180 sec/ 240 sec/ 300 sec/ OFF |
| bUrr | Audio signal: ON/OFF |
| dEFLt | Resetting to factory setting (Default setup) |
| End | Exit menu |

6 Operation

6.1 Controls 4-button terminal

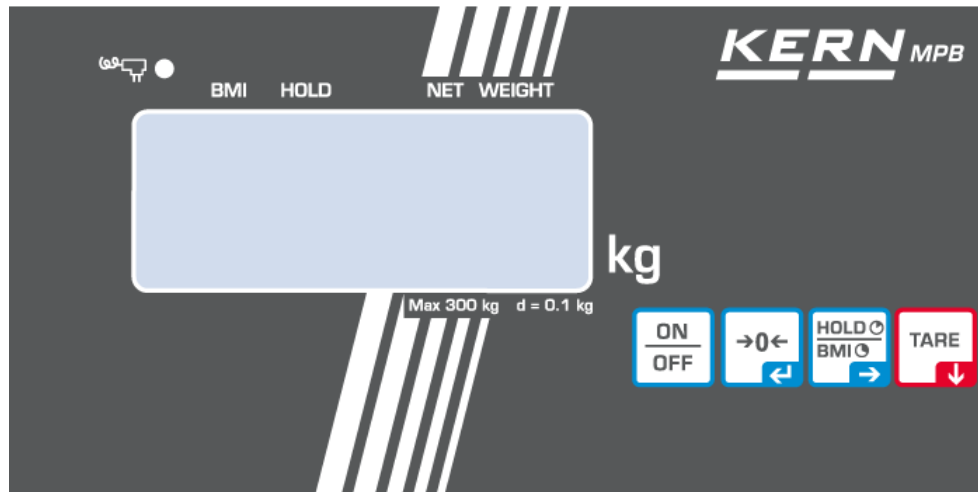

6.1.1 Display



Overview of display

| No. | Display | Description |
|-----|-------------|--|
| 1 | [→0←] | Balance zero display: Should the balance not display exactly zero despite an empty scale pan, press the [→0←] button. Your balance will be set to zero after a short standby time. |
| 2 | [o] | Stability display: If the display shows the stability display [o] the balance is in a stable status. The [o] indication disappears if the condition is unstable. |
| 3 | | Illuminates in the event of power supply via mains adaptor |
| 4 | BMI ▲ | Calculated BMI value |
| 5 | HOLD ▲ | Hold/Save function active |
| 6 | NET ▲ | Net weight will be displayed |
| 7 | WEIGHT ▲ | Current weight value will be displayed |

6.1.2 Keyboard overview

| Key | Description |
|---|--|
| ON/OFF | Turn on/off balance |
|  | Balance will be reset to 0.0 kg. Possible up to max. 2 % or 100% of maximum load (can be selected in the menu) In BMI Mode: Acceptance of input |
| HOLD | Hold function/Calculation of a stable weight value |
|  | Function call-up: Body Mass Index In BMI Mode: Moving the input point |
|  | Tare balance In BMI Mode: Reducing the input value |

7 Using the balance

7.1 Weighing

- ⇒ Turn on balance by pressing the **[ON/OFF]** key. The balance carry out a segment test, then the program version is displayed. Your balance is ready to weigh as soon as the "**0.0 kg**" display appears.
Information: The **[→0←]** key can be used to set the balance to zero at any time.
- ⇒ Place person in the centre of the balance or place baby in the scale pan. Wait until the standstill display (**o**) appears, then read the weighing result.

Note:

If the person is heavier than the weighing range, "Err" (=overload) will appear in the display.

7.2 Taring

The tare weight of any preloads can be deducted by pressing a button so that the actual weight of the person is displayed in subsequent weighings.

- ⇒ The balance will display 0 if, for example, a rubber mat has been placed on the weighing plate.
- ⇒ To start the taring process press the **[TARE]** key. The weight will now be saved internally and **0.0 kg** will be displayed.
- ⇒ Place the person in the middle of the weighing plate.
- ⇒ Now read the weight from the display.

Information:

The balance is able to only store one taring value at a time.

When the balance is unloaded the saved taring value is displayed with negative sign. Remove all items from the weighing plate in order to delete the stored tare value and subsequently press the **[TARE]** key.

7.3 Hold function (Standstill function)

The balance has an integrated standstill function (mean value calculation). With this function it is possible to weigh people accurately even if they do not stand still on the weighing plate.

Note: There is no average value calculation in the event of too much movement.

- ⇒ Turn on balance by pressing the **[ON/OFF]** key. The balance will carry out a self-test Your balance is ready to weigh as soon as the “**0.0 kg**” display appears.
- ⇒ Place the person in the middle of the weighing plate.
- ⇒ Press the **[HOLD]** button. A triangle starts to flash in the display, during this time the balance will record several measuring values and will then display the calculated average value.
- ⇒ Press the **[HOLD]** button repeatedly to reset the balance to normal Weighing mode.
- ⇒ Press the **[HOLD]** button once more to repeat this function as often as required.

7.4 Calculation of the Body Mass Index

After the balance have displayed **0.0 kg** at standstill, the person should stand in the middle of the weighing plate. Wait until the weighing value has stabilised. Then keep the **BMI** button depressed for 3 seconds. Now enter the body height.

It should be noted that a reliable calculation of the BMI is only possible with a body height of between 100cm and 250cm and a weight >10kg.

The lefthand figure of the body height last entered will flash in the display.

e.g. „1“70.0. Press the **Hold** button to reduce the item and the **Tare** button to reduce the value. Press the **→0←**-button to confirm the input and then the BMI of the person will be displayed.

When the BMI value is displayed, it is presented in the display with an arrow pointing to **BMI**. To return to normal Weighing mode, press the **→0←**-button once more and the arrow pointing to **BMI** will disappear.

7.4.1 Classification of BMI values

Weight classification for adults over 18 years of age using the BMI in accordance with WHO, 2000 EK IV and WHO 2004.

| Categorie | BMI (kg/m²) | Risk of diseases associated with overweight |
|--------------------|--------------------------------|--|
| Underweight | < 18.5 | low |
| Normal weight | 18.5 – 24.9 | Average |
| Overweight | ≥ 25.0 | |
| Pre-adipose | 25.0 – 29.9 | A bit high |
| Adipose degree I | 30.0 – 34.9 | High |
| Adipose degree II | 35.0 – 39.9 | High |
| Adipose degree III | ≥ 40 | Very high |

8 Error message

Messages can be displayed when the balance are switched on or in operation.

Lo : Batteries are run down
ErrL : The balance detects underload
ooooo: The weighing plate was loaded during switch-on, empty the weighing plate.
Err: Overload, too high load on weighing plate

9 Service, maintenance, disposal

9.1 Cleaning

Disconnect the unit from the mains power supply prior to cleaning.

Do not use aggressive cleaning agents (solvents or similar) but only a damp cloth with mild soapsuds, or household cleaner. Ensure that no liquid gets inside the unit and rub with a soft, dry cloth.

Loose dirt can be removed carefully with a brush or hand-held vacuum cleaner. Balance must not be tilted or rotated for cleaning, as damage may occur.

Remove dirt immediately.

9.2 Service, maintenance

The appliance may only be opened by trained service technicians who are authorized by KERN.

Before opening, disconnect from power supply.

9.3 Disposal

Disposal of packaging and appliance must be carried out by operator according to valid national or regional law of the location where the appliance is used.

10 Instant help

In case of an error in the program process, briefly turn off the balance and disconnect from power supply. The weighing process must then be restarted from the beginning.

Help:

| Fault | Possible cause |
|--|--|
| The displayed weight does not glow. | <ul style="list-style-type: none">• The balance is not switched on.• The mains supply connection has been interrupted (mains cable not plugged in/faulty).• Power supply interrupted.• (Rechargeable) batteries are inserted incorrectly or empty• No (rechargeable) batteries inserted. |
| The displayed weight is permanently changing | <ul style="list-style-type: none">• Draught/air movement• Table/floor vibrations• The weighing plate is in contact with foreign bodies or is not correctly positioned.• Electromagnetic fields / static charging (choose different location/switch off interfering device if possible) |
| The weighing result is obviously incorrect | <ul style="list-style-type: none">• The display of the balance is not at zero• Adjustment is no longer correct.• Great fluctuations in temperature.• Warm-up time was ignored.• Electromagnetic fields / static charging (choose different location/switch off interfering device if possible) |

Should other error messages occur, switch balance off and then on again. If the error message remains inform manufacturer.

11 Declaration of Conformity

To view the current EC/EU Declaration of Conformity go to:

www.kern-sohn.com/ce