



PROACTIV[®]













Usage instructions Service booklet

LIFT activ
LIFT solid
mechanical & electric

Contents

1	Preface	5
2	Legend.....	5
3	Conformity/other information.....	5
3.1	Classification.....	5
3.2	Conformity.....	5
3.3	Manufacturer.....	5
4	Scope of delivery and testing the product on receipt	5
5	Introduction.....	6
6	Intended purpose and indication	6
7	Proper use.....	7
8	Technical specifications	7
8.1	Product weight.....	7
8.2	Load weight.....	7
8.3	Obstacle height and turning circle	7
8.4	Basic equipment and dimensions.....	8
8.5	Service life	8
9	Rating plate & markings on the product.....	8
10	Commissioning and handover.....	8
11	Introduction to the product & the surroundings	9
12	Safety instructions – prior to driving/use	9
13	Safety instructions – while driving/using	10
14	Lift mechanism – safety instructions	11
15	Safety instructions regarding obstacles	12
16	Safety instructions regarding dangerous locations and dangerous situations.....	12
17	Safety instructions – after driving/use	13
18	 Individual setting options	13
18.1	Adapting the seat height at the back (LIFT solid).....	13
18.2	Adapting the seat height at the front/the seat angle (LIFT solid).....	13
18.2.1	Adapting by positioning the caster wheels in the caster fork.....	13
18.2.2	Adaptation by replacing the caster fork	14
18.2.3	General instructions	14
18.3	Adjusting the tipping point.....	14
18.3.1	Adaptation on the LIFT activ.....	15
18.3.2	Adaptation on the LIFT solid.....	15
18.3.3	General instructions	16
19	Back system	16

19.1 Lumbar support/curvature.....	16
19.1.1  Back tube with lumbar joint (LIFT activ).....	16
19.1.2 Back tube with lumbar curvature	17
19.2 Backrest angle	17
19.2.1 Adjustment option for folding backrest.....	17
19.2.2 Instructions for sitting posture with an adjustable backrest	17
19.2.3 Adaptation of the backrest angle for the folding backrest.....	18
19.3 Adjustable back & its adjustment options	19
19.4 Ergonomic back shell & its setting options	22
19.5 Ergo Back backrest bar and its adjustment possibilities	23
20 Seat system.....	23
21 Clothing guard	24
21.1 Overview of terms.....	24
21.1.1 Overview for LIFT activ	24
21.1.2 Overview for LIFT solid	24
21.2 Removing and attaching the clothing guard (LIFT solid).....	25
22 Drive wheels	25
22.1 Removing and attaching the drive wheels.....	25
22.2  Checking and adjusting the wheel tracking of the drive wheel.....	26
22.3  Wheel camber.....	28
22.4 Tyre pressure.....	28
22.5 Other	29
23 Caster wheels.....	29
23.1  Replacing the caster wheels.....	29
23.1.1 Replacing the caster wheels when mounted using two axle fixing screws	30
23.1.2 Replacing the caster wheels when mounted using an axle fixing screw and nut.....	30
23.2 Caster wheels flapping	31
23.3 Replacing the caster forks	32
23.3.1  Caster fork with screw-on axle on angle-adjustable caster-wheel bearing blocks (LIFT solid).....	32
23.3.2  Caster fork with screw-on axle with welded caster wheel bearing blocks	33
23.3.3 Caster forks with quick-release axles	34
23.4  Adjustment of the caster fork rotary axles (LIFT solid).....	34
24 Footrests.....	36
24.1  Angle adjustment of the footplate support.....	36
24.2 Footrest continuous	36

24.3	Footrest fold up to the rear	37
24.4	Footrest fold up to the rear with spring locking mechanism	38
24.5	Divided footrest	39
24.6	Removable frame stem, foldable with divided footrest	40
24.7	Swing away footrest (LIFT solid)	41
24.8	Safety instructions	43
25	Anti-tipping support	43
25.1	LIFT activ	43
25.1.1	Overview of terms	43
25.1.2	Operating and passive position	43
25.2	LIFT solid	45
25.2.1	Overview of terms	45
25.2.2	Operating and passive position	45
25.3	Removing and attaching the anti-tipping support	45
25.4	Safety instructions	46
26	Brakes	46
26.1	Knee lever brake	46
26.1.1	Opening and closing the brake	46
26.1.2	 Setting the brake in a low position & installed at the rear (LIFT solid) & installed at the front (LIFT activ)	47
26.1.3	 Setting the brake on the LIFT solid installed on the armrest	49
26.1.4	 Setting the brake on the LIFT solid, double knee lever brake	50
26.2	Integral parking brake on the LIFT activ	50
26.2.1	Opening and closing the brake	50
26.2.2	 Setting the integral brake	51
27	Push handles	52
27.1	Back tube with integrated handles	52
27.2	Aluminium push handles fixed in back tube	52
27.3	Push handles, horizontally screwed in back tube	53
27.4	Safety push handles with continuous height adjustment	53
27.5	Safety push handles back-positioned	54
27.6	Safety instructions	55
28	Lift system	55
28.1	Lift system on the LIFT activ	55
28.1.1	 Setting the pretension	55
28.1.2	Unlocking & locking the lift function	55

28.1.3	Adjusting the seat height	56
28.2	Mechanical lift system on the LIFT solid.....	56
28.2.1	Folding the armrests up/down before/after transport.....	57
28.3	Electric lift system on the LIFT solid	57
29	Rechargeable battery & charger for electric seat height adjustment on the LIFT solid	58
29.1	Technical specifications for the rechargeable battery	58
29.2	Charging the rechargeable battery	58
29.3	Removing the rechargeable battery	59
29.4	Safety instructions	60
30	Storage	60
31	Transport	61
31.1	Securing handling of the product.....	61
31.2	Passenger transport in motor vehicles	61
31.3	Securing the product in a vehicle (without a person)	61
31.4	Passenger transport over obstacles in the product.....	62
31.5	Transport in aircrafts (LIFT solid electric).....	62
32	Malfunctions	62
33	Cleaning and care	62
34	Maintenance.....	63
34.1	General instructions.....	63
34.2	Service schedules.....	63
34.3	Proof of maintenance.....	64
35	Disposal & recycling	64
36	Re-use	65
37	Warranty	65
38	Liability.....	66
39	Appendix: Tightening torques, securing details and tools.....	67
40	Appendix: Medical product passport/record of training	68
41	Appendix: Hand-over certificate	69
41.1	Required compliance criteria to authorise use	69
41.2	Check list for training the user	70
42	Appendix: Inspection lists.....	71



The following instructions are intended for and may only be carried out by the rehabilitation specialist dealer or PRO ACTIV.



This document is available in PDF format at www.proactiv-gmbh.com for visually impaired people. Using the zoom function, the font can be increased as desired.

1 Preface

Dear Customer,

Congratulations on purchasing your new PRO ACTIV product. You have bought a quality product that has been specially customised to meet your requirements. We have put together some important instructions about its proper and safe use in the following document. Please read these instructions before using the product.

The standard components are explained in these usage instructions. If you have individual solutions or non-standard components on your product, your rehabilitation specialist dealer or PRO ACTIV would be happy to deal with any questions you may have about using it.

The LIFT activ & solid products differ in the individual design of the frame geometry and the options available. If there is a difference in the selection of options, this is mentioned in the respective chapter. Otherwise the operating instructions are identical.

You can always download the latest version of the usage instructions as a PDF document in our download area at www.proactiv-gmbh.com.

If you have any further questions about this or any of our other products, we would be glad to be at your disposal.

Enjoy your trips and the best possible mobility.

Your PRO ACTIV team

2 Legend

The symbols used in these usage instructions have the following meanings:



Manufacturer



Warnings and safety instructions



Serial number

3 Conformity/other information

3.1 Classification

LIFT activ & solid rigid frame wheelchairs (referred to as "product" below) are classified as class I products.

3.2 Conformity

 As the manufacturer, PRO ACTIV Reha-Technik GmbH declares that the respective product is a class I product and meets the requirements of the EU Medical Devices Directive (2017/745).

If the product is adapted in a manner which has not been agreed by PRO ACTIV Reha-Technik GmbH, this declaration becomes void.

3.3 Manufacturer



PRO ACTIV Reha-Technik GmbH

Im Hofstätt 11

D-72359 Dotternhausen

Phone +49 7427 9480-0

Fax +49 7427 9480-7025

e-mail: info@proactiv-gmbh.de

web: www.proactiv-gmbh.com

4 Scope of delivery and testing the product on receipt

Delivery includes the product, configured as per the purchase order, with the usage instructions including the training/hand-over certificate and inspection lists. You can view the basic equipment in chapter "Technical specifications". As per your order, the product is equipped with additional recommended accessories, such as push handles, anti-tipping supports and a lap belt.

Please check that the delivery is complete after you have received your product.

The product is tested to ensure it is completely functional before shipping and packed in special boxes. The lifting movement is blocked by a safety belt, which is routed around the lower parallelogram arm and the rear frame cross bar. This safety belt must be removed before using the wheelchair. For further transport, the

lift mechanism must always be blocked by this safety belt.

Please check the product immediately upon receipt, preferably in the presence of the freight company, for any damage that may have occurred in transit. If you are of the opinion that damage has occurred during transit, please do the following:

1. Record a statement of facts in the presence of the freight company - photo documentation of the packaged product and the unpacked product with detailed images of product damage
2. Preparation of a declaration of assignment - you assign all claims from this damage to the freight company.
3. Statement of facts/photo documentation, delivery note, and declaration of assignment are sent to PRO ACTIV.

Failing to observe these instructions, or reporting damage after acceptance, means that the damage cannot be acknowledged.

PRO ACTIV will subsequently review the damage and discuss additional steps with you (shipment of replacement parts, returning the product to PRO ACTIV for a complete repair, etc.).

5 Introduction

Before starting your first journey, familiarise yourself with these usage instructions, paying particular attention to all of the safety information and hazard warnings contained in them.

Allow your therapists and doctors to advise you as well as your carers and assistants on how to use the product and what you are permitted to do with the product based on your current ability. Clarify with them as well which wheelchair techniques you can learn on the basis of your ability.

 Under no circumstances should you do anything with or in the product that you have not learned to do and have not mastered.

You, your carers, and assistants should also seek advice from your therapists and doctors as well as the rehabilitation specialist dealer about the use and settings of your product and all the safety accessories available (e.g., anti-tipping supports and lap belt).

 You should always heed the advice provided by doctors, therapists and the rehabilitation specialist dealer on the necessary safety accessories.

 If you are not sure how to handle the product or if technical faults occur, please contact your rehabilitation specialist dealer or PRO ACTIV before using it.

 Never leave the product unattended.

 Secure the product against unauthorised use and theft.

 When combining your product with equipment made by other manufacturers (e.g. seat cushions, drive devices, etc.), make sure that the suitability of the individual components and the unit made up of them is ensured. Information on the suitability of the combination can be obtained from the manufacturer of the third-party components or from your rehabilitation specialist retailer.

 The product contains small parts that may pose a choking hazard for children.

6 Intended purpose and indication

This product offers persons who have difficulty walking or cannot walk the option of replacing walking with driving using a muscle-powered wheelchair to a technically feasible extent. The objective is to maintain or increase the greatest possible independent mobility and to integrate the active wheelchair user in everyday life.

Indications: Walking impediment or limited ability to walk due to paralysis, limb loss, limb defect/deformation, joint contractions/joint damage, neurological and muscular diseases.

Contraindications: Some wheelchair options are unsuitable for certain disease profiles or

handicaps. A suitable selection will be made by the therapist/doctor/rehabilitation specialist dealer during the consultation.

In addition - for safety reasons - the product may only be operated by people who

- can move and coordinate their hands and arms so that they are able to operate all control elements without restrictions while using the wheelchair.
- are physically and mentally capable and have the visual ability to safely operate the product in all operating situations and can meet the legal requirements for use on public roads. For children or people with mental, significant motor or visual impairments, the attendants can ensure the required traffic safety as a substitute and as a companion.
- have been trained in its use by the rehabilitation specialist dealer or PRO ACTIV.

7 Proper use

This wheelchair is designed for use on level and solid surfaces indoors and outdoors. Avoid driving on unpaved or loose surfaces (e.g. on loose gravel, in sand, mud, snow, ice or through deep puddles of water, and under poor weather conditions (e.g. storms), as this may result in incalculable risks.

Thanks to the infinitely variable seat height adjustment, the LIFT activ & solid active wheelchairs are particularly suited for use at the workplace or at home with conventional furniture and kitchen facilities. With the **LIFT activ**, a low wheelchair weight and a small pack size make it easy for active wheelchair users to load it in a vehicle.

With the **LIFT activ**, the maximum permitted load of the product in its standard design is 100 kg. Individual customisation can be made to accommodate a higher load; this will be indicated on the ratings plate.

With the **LIFT solid**, the maximum permitted load of the product in its standard design is 120 kg. The heavy-duty version and individual

customisations can be designed for a higher load; this is then indicated on the rating plate.

Please note that the load limit indicated on the rating plate may not be exceeded even when transporting objects and carrying out strength exercises in the product. Note that the maximum load weight is reduced accordingly when mounting components with low load limits on the product, e.g. drive wheels with few spokes.

Proper use of the product is a basic requirement of safe operation. The product may generally be used only for applications that are listed and described in these usage instructions. This includes storage, transport, maintenance/inspection, and repair, as well as the safety information in each chapter of these usage instructions.

8 Technical specifications

8.1 Product weight

LIFT activ:

The total weight starts from 14.5 kg with the basic equipment.

LIFT solid:

The total weight with basic equipment in the mechanical version starts at 21 kg, and at 29 kg in the electric version.

8.2 Load weight

Maximum load weight, LIFT activ:

Up to 100 kg payload

Maximum load weight, LIFT solid:

Up to 120 kg payload

The heavy-duty version and individual customisations can be designed for a higher load; this is then indicated on the rating plate.

8.3 Obstacle height and turning circle

Maximum drive-over/negotiable obstacle height: 10 cm

Turning circle:

- approx. 1.3 m without manoeuvring back and forth
- approx. 1.1 m with manoeuvring back and forth (strongly dependent on the number of manoeuvres)

8.4 Basic equipment and dimensions

In the basic equipment, the product is equipped with seat and back system, side sections, caster wheels, drive wheels including tyres and handdrims, knee lever brake and foot-rest.

Dimensions LIFT activ:

Seat width: 35 - 46 cm | Seat depth: 35 - 48 cm
 Back height: 20 - 48 cm
 Wheel camber: 1°; 2.5°; 4°
 Back angle: Seat tube / back tube opening angle 70° - 95°

Dimensions LIFT solid:

Seat width: 30 - 50 cm | Seat depth: 25 - 48 cm
 Back height: 20 - 48 cm
 Wheel camber: 1°
 Back angle: Seat tube / back tube opening angle 70° - 95°

8.5 Service life

The service life of the product is 6 years.

9 Rating plate & markings on the product

The **rating plate** is located on the product frame. The rating plate includes the precise model, the serial number and other technical specifications.

When contacting your rehabilitation specialist dealer or PRO ACTIV with regard to your product, please always have the serial number and year of construction on the rating plate at hand.

		Modell model
Reha-Technik GmbH Im Hofstätt 11 D-72359 Dotternhausen www.proactiv-gmbh.de	 serial number
	 date of manufacture
		max. Zuladungkg max. load
		max. Anhängelastkg max. towed capacity

CE marking
 “European conformity”

Medical device

Manufacturer

Follow the usage instructions

Serial number

Date of manufacture

Electric components must be properly disposed of at government-designated recycling facilities (for el. LIFT)

The product is labelled with **further symbols** (stickers):

Product not approved as a seat in motor vehicles

Product approved as a seat in motor vehicles; marking of the transport restraint system connections on the wheelchair or fastening points for wheelchair restraint systems

More detailed information about this can be found in chapter 31.

10 Commissioning and handover

The product will be handed over to you ready for use by a rehabilitation specialist dealer or a

field representative or by a product consultant from PRO ACTIV.

You will be fully instructed in the use of the product based on the usage instructions included in the delivery. You will be handed over a record of training and handover certificate as written proof. In addition, you will be handed the usage instructions and, if necessary, further accessories for your own use. It is recommended that you take along an assistant to the training so that, if required, they can assist you later when handling the product.

During the hand-over, the record of training (Chapter 40) and the hand-over certificate including the associated check list (Chapter 41) must be filled in. The rehabilitation specialist dealer should send the completed documents to PRO ACTIV for filing as a file by e-mail or in the form of a copy by fax or in the post.

11 Introduction to the product & the surroundings

During the initial commissioning of the product, drive at minimum speed and become accustomed to the driving characteristics of the product. Always adapt the speed and driving manoeuvres to match your own abilities and external circumstances. You will get a feel for how to use the product safely after a short time. Before driving up or down slopes or hills with the product, you should be proficient in the safe handling of the product on level ground.

Familiarise yourself with the lift function and the changes in the centre of gravity in a lifted state. Before you take on additional loads, you should be comfortable with the lift function.

Practice bending over, gripping, stretching and getting out, until you know the limits of your abilities. Allow yourself to be assisted until you know what can cause falls or tips and how to avoid it.

Get to know the environment in which you wish to use the product. Look out for obstacles and learn how to overcome or avoid them.

12 Safety instructions – prior to driving/use

 When getting into the wheelchair, do not tread on the footrests as this may tip the chair over.

 Before every trip, check the condition of the wheels (e.g. visual inspection of the spokes and rims, check the tyres for damage, foreign bodies and crack formation). If you have any doubts about the serviceability of the product, stop using it.

 Check the tyre pressures at regular intervals. Ensure that you comply with the manufacturer's specifications which can be found on the tyres. If the tyre pressure is too low, the optimum functional capability of the knee lever brake is not guaranteed, and an excessively low tyre pressure influences the driving behaviour. Apart from that, there is an increased risk of a flat tyre.

 Before starting out, check that the product's brake works. If all existing brakes are not fully functional, no trips may be taken.

 Check the stable condition of the seat and backrest upholstery at regular intervals and in case of doubt, have your rehabilitation specialist dealer assess its condition.

 Always ensure that your feet cannot slip off the footplate support when using the product.

 Before using the product, ensure that the anti-tipping supports are in the operating position and are functional.

 Due to environmental effects, it is possible that the properties and therefore secure attachment of the push handle covers may change detrimentally. For this reason, it is important to check that the handles are tightly fitted and fixed in position prior to use. If this should no longer be the case, then the push handles may not be used until they have been fixed.

 Before each use of the product, make sure that the anti-tipping supports and push handles are firmly attached and the quick-release axles on the caster and drive wheels are also securely locked in place.

 Depending on equipment, the product may have folding/closing mechanisms that pose a risk of crushing injuries (e.g. trapping your fingers). Therefore, have your rehabilitation specialist dealer explain how these mechanisms work and test them yourself under supervision.

 If required, you can have your product equipped with a suitable chest or lap belt. Make sure that the belt is worn so that it does not negatively affect your breathing, cannot strangle you if you fall or tip out of the product and so that you can easily remove it yourself.

 Make sure that the passive illumination (reflectors) are always on your product, are in perfect condition and are clearly visible.

 When travelling, always carry a repair kit and tyre pump for repairs in event of punctured/flat tyre. An alternative to this is an emergency puncture repair spray that fills your tyre with a foam that hardens in the tyre.

13 Safety instructions – while driving/using

 Note that some parts of your product can become extremely hot at high ambient temperatures (e.g. sauna). This means that above 50°C, the product may be damaged and above 40°C there is already the risk of burns for the user, which should not be underestimated, particularly for people with impaired sensitivity. For this reason, the product should not be exposed to such extreme temperatures. PRO ACTIV cannot accept any liability or provide any warranty for personal injury and material damage caused by such stresses. There are also certain risks that exist at extremely low temperatures, which must be minimised by

wearing appropriately insulating clothes, for example.

 You may only drive on slopes where the product can be safely controlled with the handrims. Never drive the product on slopes of more than 10%.

 When driving in curves, reduce your speed to a minimum and if possible, lean your upper body towards the curve.

 Do not ride parallel to slopes and inclinations due to the risk of tipping.

 Do not stop on a steep slope, otherwise there is a risk of losing control of the product. If possible, do not turn on a slope or change your direction.

 Note that the knee lever brake and the integrated brake are parking brakes that may only be applied when the product is at a standstill. These are not service brakes that are suitable for reducing speed.

 Do not attach objects (carrier bags, etc.) to the product.

 When driving in areas that are approved for pedestrians, keep to the maximum permitted speed (walking speed 6 km/h) and maintain sufficient lateral distance (at least the width of a wheelchair) from obstacles and other road users.

 Avoid driving on unpaved or loose surfaces (e.g. on loose gravel, in sand, mud, snow, ice or through deep puddles of water).

 When travelling on poorly maintained paths (e.g. coarse gravel, potholes), there is an increased risk of puncturing your tyres as well as tipping.

 When travelling on poorly maintained paths with potholes and loose stones, drive carefully to prevent the caster wheels from blocking.

 The product can affect other devices, for example theft protection barriers in department stores.

 The product is only intended for transporting one person with limited mobility and must not be used for any other purpose, e.g. for transporting goods.

 When reversing, the anti-tipping supports should always be used as there is an increased risk of tipping over. If this is not possible, then ask other people to help ensure that there is no risk of tipping over.

 The product may only be propelled using the handrims. If you propel the chair with the tyres (thumbs or fingers on the tread of the tyre), there is the risk of crushing or otherwise injuring fingers and thumbs.

 Do not reach into the area of the spokes or other tight spaces in the area of the wheels. There is an increased risk of being injured here, particularly while in motion. If you have limited coordination of your limbs, then you should cover the spokes with a spoke shield, for example, to minimise the risks.

 Smoking when using the wheelchair should be forgone, as the seat and back system may be damaged due to dropping ash.

14 Lift mechanism – safety instructions

 The product is delivered with a lift mechanism that is customised to the user's body weight. For this reason, the product may only be used by this user, because the lifting and lowering behaviour changes when it is used by other people with a different body weight.

 The gas pressure springs must not be opened or heated. For service or repair work, inform your rehabilitation specialist dealer or contact PROACTIV.

 The lifting movement of the product must only be executed with the parking brake brake is applied, the anti-tipping support in active position, and on a level surface.

 The product must not be moved or pushed by the user or someone else when the seat is lifted.

 While executing the lifting or lowering movement or when the seat is in a lifted state, it is essential to observe the following points:

- The upper body must not be tilted to the front, rear or to the sides beyond the wheelchair seat (risk of tipping).
- The additional load picked up by the user must not exceed 10% of the body weight. The additional load must not be picked up or put down from/to the side, rather only from/to the front in an upright seated position. During the lifting movement, the load must be resting on the thighs.
- During the lifting or lowering movement with the **LIFT activ**, both hands must be holding the release handles in the middle, the fingers must not be spread apart.
- During the lifting or lowering movement with the **LIFT solid**, both hands must be holding the armrests in the middle, the thumbs must not be spread apart.
- Neither the user nor the accompanying person may reach under the seat into the mechanics area of the product.

 When using the lift mechanism, the product may only be exposed to ambient temperatures between -5 and 40°C. This means, for example, that use in climatic chambers or in saunas is not permitted. It is not permitted to use the lift mechanism near open fires or other thermal radiators if there is a risk that this temperature can be exceeded.

 The product must stand on level, flat and solid ground. All four wheels must stand securely on the ground, i.e. not in the area of e.g. thresholds or floor transitions. The traction of

the wheels must not be impeded by moisture, snow, ice, cleaning agents, lubricants, fuel, etc. Using the product in the water or on sandy or unsurfaced ground is not permitted.

15 Safety instructions regarding obstacles

 Driving on steps with the product is forbidden.

 Due to the significantly high risk of tipping and injury, the product should only be used to negotiate escalators after participation in a corresponding safety training course and with an accompanying person for safety reasons.

 The maximum obstacle height which can be negotiated is 10 cm.

 When driving over or passing obstacles, it is important that you avoid any product or body parts catching on the obstacle as this may lead to falls causing serious injuries to the user and third parties as well as damage to the product.

 Always drive over curbs or other obstacles so that you cross them to the front or at right angles and at the minimum required speed. When approaching an obstacle at an angle or driving over it with just one drive wheel, there is an increased risk of tipping over sideways.

 If the product with the user needs to be transported over an obstacle and there are suitable facilities such as a ramp or a lift available, then these should be used. If such facilities are not available, then the obstacle is to be overcome by being carried by two helpers. When carrying the product, it may not be lifted by the side sections, the drive wheels or the footrests. We recommend holding the product on the frame and the back cross bar to carry it.

 Before crossing an obstacle (steps, thresholds, etc.), the anti-tipping supports must be swivelled (**LIFT activ**) or plugged (**LIFT solid**) from the operating to the passive position, so that you do not make contact with the

obstacle when crossing, which could cause you to fall. After crossing the obstacle, the anti-tipping supports must be immediately returned to the operating position (Chapter 25).

 For overcoming obstacles such as kerbs or steps, the product needs to be actively tipped. The caster wheel may otherwise jam at right angles to the obstacle and could block. This could damage the caster wheel or the caster fork and result in injury to the user. If actively tipping it is not possible, then the obstacle should not be approached or you need to request assistance from an accompanying person. Particular attention needs to be paid to this when using an auxiliary drive.

16 Safety instructions regarding dangerous locations and dangerous situations

The operator of the product determines the route to be driven themselves, taking the usage instructions, their driving knowledge, and physical abilities into consideration.

Personal driving skills are particularly important in the following dangerous locations that are provided as examples; the product user must use their judgement before driving in such locations:

- quay walls, landing and berthing locations, paths and locations close to water, unsecured bridges and dykes.
- narrow paths, slopes (e.g. ramps and driveways), narrow paths on a slope, mountainous routes.
- narrow and/or steeply sloping paths along main roads or near cliffs.
- routes that are covered in leaves, snow or ice.
- ramps and lifting equipment on vehicles.

 When driving in a curve or turning on hills or downward slopes, there may be an increased tendency to tip over to the side due to

the changes in the centre of gravity. Avoid such driving manoeuvres. If these cannot be avoided, perform these driving manoeuvres with increased caution and only at a very slow speed. If necessary, the driving manoeuvre must not be performed or only with the help of an assistant.

 Use particular caution when approaching stairs, edges, drops or other hazard areas.

 Extreme caution is needed when crossing main roads, intersections and level crossings. Rails in the road or level crossings must never be crossed when travelling parallel to them, as otherwise the wheels could become caught which would result in the product being unable to manoeuvre.

 Extreme caution is needed when driving on ramps and lifting equipment on vehicles. Ensure in advance that the ramp is wide enough so that you do not risk the product wheels slipping off the ramp. When lifting or lowering a ramp or lifting equipment, the parking brake of the product should be applied. Always keep the product in the middle of the ramp.

 The grip of the tyres on the ground is reduced under wet conditions. There is an increased risk of slipping. Adjust your driving, braking and steering behaviour accordingly.

17 Safety instructions – after driving/use

 Apply the parking brake before getting out of the product.

 When getting out of the wheelchair, do not tread on the footrest due to the risk of tipping over.

 When getting out of the wheelchair, do not support yourself on the clothing guard (risk of pinching).

18 Individual setting options

 *The following instructions are intended for and may only be carried out by a rehabilitation specialist dealer or PRO ACTIV*

18.1 Adapting the seat height at the back (LIFT solid)

Adapting the seat height at the back is only possible on the LIFT solid.

The seat height at the back results from the choice of the drive wheel plate. Subsequent changes can only be made by replacing the drive wheel plate. In this case, contact your rehabilitation specialist dealer or PRO ACTIV.

18.2 Adapting the seat height at the front/the seat angle (LIFT solid)

Adapting the seat height at the front or the seat angle is only possible on the LIFT solid.

If the seat height has to be adjusted, the angle of the seat or the front seat height can be adjusted. This setting is carried out via the position of the caster wheels in the caster wheel fork and the caster fork size.

18.2.1 Adapting by positioning the caster wheels in the caster fork

Adjusting the front seat height or angle of seat can be carried out via the positioning of the caster wheel in the caster fork. Generally, the caster forks have three possible positions that can be used to change the front seat height in steps of 15 mm.

- If the seat inclination or the front seat height are to be increased, the caster wheel is mounted in a lower position in the caster fork.
- If the seat inclination or the front seat height are to be reduced, the caster wheel is mounted in a higher position in the caster fork.

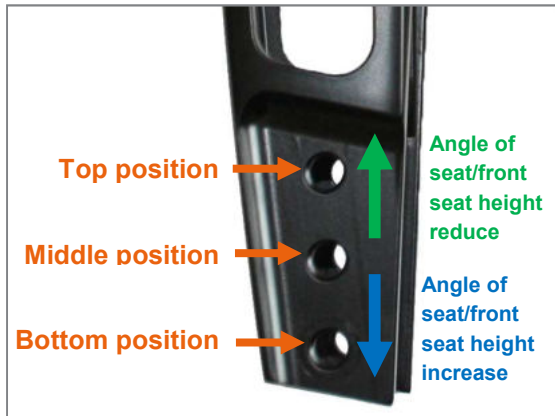

Figure 1: Three positions in the caster fork for positioning the caster wheel and its effect on the front seat height

The instructions for disassembly and assembly of the caster wheels can be found in chapter 23.1.

18.2.2 Adaptation by replacing the caster fork

If the adjustment range of the existing caster fork is insufficient, the next larger or smaller one can be used.

In doing so, the bottom position of the fork size 1 is equivalent to the top position of fork size 2 and the bottom position of fork size 2 to the top position of fork size 3.



Figure 2: Caster fork sizes with marking of the same seat height settings with different caster fork sizes

The instructions for replacing the caster forks can be found in chapter 23.3.

18.2.3 General instructions

When changing the angle of seat or front seat height each time:

- the wheel track of the drive wheels must be checked and readjusted if necessary (see Chapter 22.2).
- the caster wheel axles must be readjusted (see Chapter 23.4) (LIFT solid).
- the backrest angle may have to be repositioned (see Chapter 19.2).
- make sure that there is sufficient ground clearance under the footrest. Experience shows that this should not be less than 4 cm (see Chapter 24).

18.3 Adjusting the tipping point

Optimum product tipping behaviour is achieved when the axle mount of the drive wheels is close to the body centre of gravity. A product adjusted like this can be driven with little effort and it also makes it possible to

manage a slightly uneven surface or edges by tipping slightly. Driving on both drive wheels (doing a wheelie) is relatively easy to learn. Inexperienced wheelchair users must be prevented from tipping over backwards by means of anti-tipping supports.

To ensure safe operation, the **tipping point setting** should always be selected to suit the wheelchair user's individual requirements and abilities.

18.3.1 Adaptation on the LIFT activ

Using the M6 hexagon screws (AF 10 mm; Fig. 4), the tipping point can be adjusted in 1 cm increments within a range from 6 cm to 10 cm.

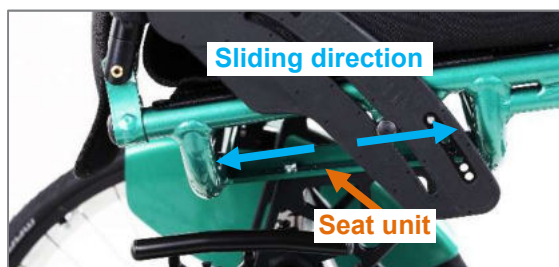

Figure 3: Seat unit on the wheelchair



Figure 4: Seat unit with hexagon screws

To adjust the tipping point, proceed as follows:

1. Loosen the four M6 hexagon screws (AF 10 mm) on both sides (Fig. 4).
2. Sliding the seat unit (Fig. 3) to the rear increases the tipping point. Otherwise, it is reduced.
3. Fix the new position by tightening the four M6 hexagon screws with a tightening torque of 7 Nm.

18.3.2 Adaptation on the LIFT solid

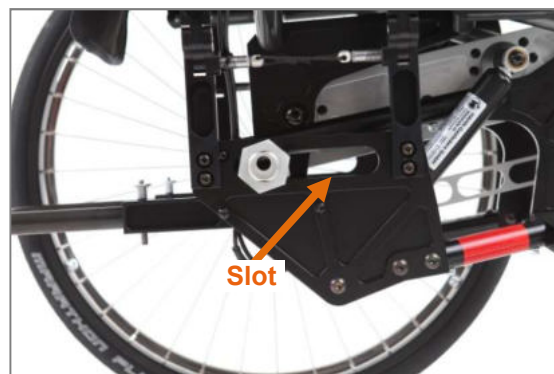

Figure 5: Wheel plate with drive wheel bushing

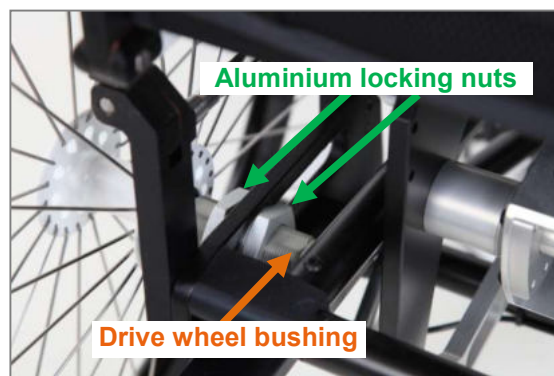

Figure 6: Drive wheel bushing and aluminium locking nut (rear view)

To adjust the tipping point, proceed as follows:

1. Loosen the aluminium locking nuts (AF 41 mm).
2. Slide the drive wheel bushing in the slot (Fig. 5) to the desired position. Sliding it to the front increases the tipping point. Otherwise, it is reduced.
3. When the desired position has been found, hold the drive wheel bushing in position using the open-end spanner (AF 22 mm) and tighten the aluminium locking nuts (AF 41 mm) with a tightening torque of 70 Nm.

18.3.3 General instructions

After each change to the tipping point:

- the wheel track of the drive wheels must be checked and readjusted if necessary (see Chapter 22.2).
- the caster wheel axles must be readjusted (see Chapter 23.4) (LIFT solid).
- the brakes must be readjusted (see Chapter 26).

Extreme settings such as drive wheels mounted far to the front or a seat frame mounted for the back are only permitted for experienced wheelchair users who are able to actively shift their weight forwards during operation.

To minimise the risk of tipping backwards, we recommend using anti-tipping supports, even with anti-tipping settings.

19 Back system

Avoid falling into the seating and backrest upholstery/back shell as it significantly increases the risk of changing the adjustment, falling down or defects.

19.1 Lumbar support/curvature

19.1.1 Back tube with lumbar joint (LIFT activ)

The following instructions are intended for and may only be carried out by a rehabilitation specialist dealer or PROACTIV



Figure 7: Back tube with lumbar joint



Figure 8: Lumbar joint with different lumbar depth (viewed removed from the product)

The lumbar depth can be adjusted between 1, 2 and 3 cm by using tools.

To adjust the lumbar depth, loosen the M5 fixing screws (AF 3 mm) on both sides (Fig. 9) and pull the lumbar joint out of the back tubes.

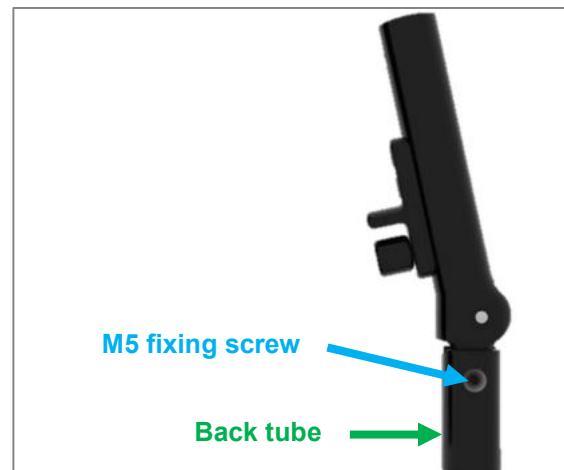

Figure 9: Lumbar joint with lumbar depth of 1 cm in the back tube

Then pull out the cylindrical pin on both sides and position the lumbar joint in the desired position (Fig. 10).

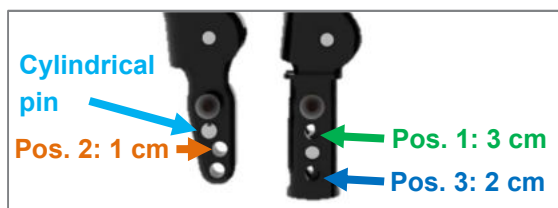

Figure 10: Lumbar joint with view from the inside (left) and from the outside (right)

In the next step, fix the position by inserting the cylindrical pin in the desired hole position.

Finally, now slide the lumbar joints back into the back tubes and screw the lumbar joints onto the back tubes with the M5 fixing screws (AF 3 mm) with a torque of 6 Nm (Fig. 10).

19.1.2 Back tube with lumbar curvature



Figure 11: Back tube with lumbar curvature (LIFT solid)

The backrest can be freely selected with a lumbar depth of 1, 2 or 3 cm. There is **no** subsequent adjustment option.

19.2 Backrest angle

19.2.1 Adjustment option for folding backrest



Figure 12: Side section with folding backrest (lifted up)

If equipped with an adjustable and foldable backrest, the backrest angle can be flexibly adjusted without using tools and the backrest can be completely folded away. The angle of the backrest can be fixed in 7 positions in 5° steps.

 Observe that the centre of gravity is shifted further to the rear by the enlargement of the angle between the backrest and the seat system and thus, the tipping point of the product is reached much sooner.

19.2.2 Instructions for sitting posture with an adjustable backrest

For a good sitting posture, we recommend positioning the backrest vertical to the ground, where possible.

With low backrests with adaptable belt cover due to a disability, it may be advantageous to slightly tilt the backrest forwards and to slacken the top belt of the backrest upholstery so that the slack in the upper area is greater in order to achieve good sitting stability under certain circumstances (see Chapter 19.3).

The adjustment possibility of the backrest angle supports active sitting and ensures for flexibility of the wheelchair user. An example in the following:

- If the angle of the seat has been changed (see Chapter 19.2), the angle of the backrest can be respectively readjusted.
- When driving on slopes and when transporting baggage (e.g. backpacks) on the backrest, the centre of gravity shifts more to the rear and the risk of tipping increases. Then this can be counteracted by a respective angle adjustment of the backrest to the front.
- For comfortable seating, the backrest can be locked in a position to the rear so that the backrest is tilted slightly back.

19.2.3 Adaptation of the backrest angle for the folding backrest

To **adjust the backrest angle**, relieve it (otherwise there is a risk of tipping) and then loosen the locking pins that engage in the locking holes of the side sections on the left and right. For this purpose, grasp under the seat cover and in the middle, pull the cord to the front that is linked to the locking pin.



Figure 13: Locking pin connected to a cord (view from inner side of product)

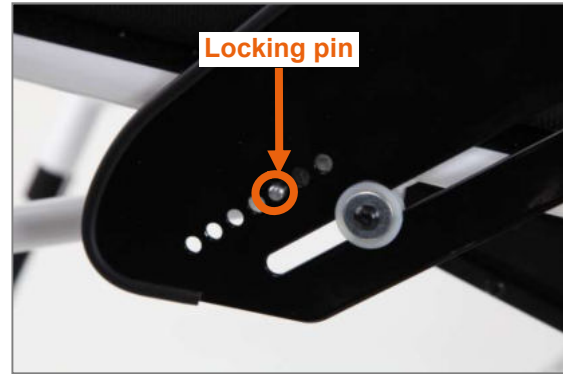

Figure 14: Locking pin engages in the locking hole in the side section (view from outer side of product, without clothing guard)

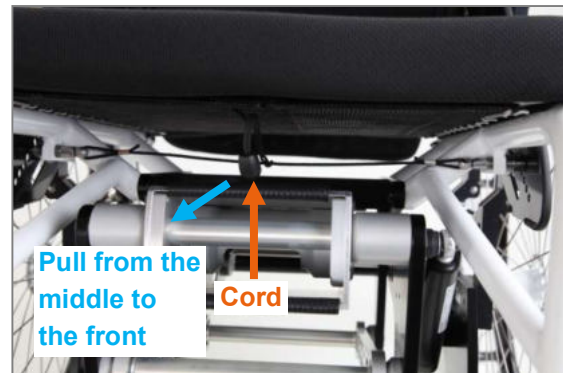

Figure 15: Cord for operating the locking pin and thus for adjusting the angle of the backrest

If you have released both locking pins by pulling on the cord, you can adjust the backrest as desired and re-engage it by letting go of the cord. In doing so, before applying load again, make sure that both locking pins have engaged safely into the desired locking holes (the same position on the right and left).

A stop pin may be mounted in the backrest angle **adjustment range** as a limiter.

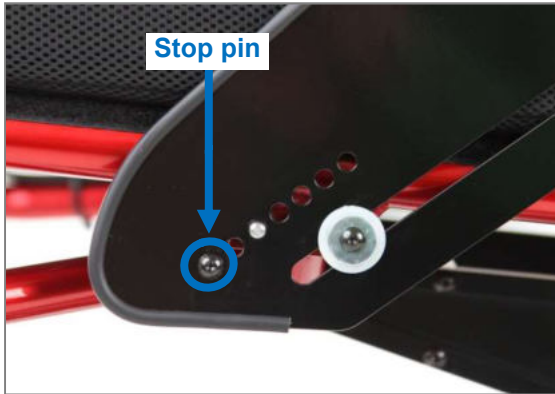



Figure 16: Stop pin (view from outer side of product)

 Depending on the adjustment of the backrest angle, check the tight engagement of the backrest via the locking pins.

To **fold down the backrest**, pull on the middle of the cord towards the front, and at the same time, fold the backrest downwards until it rests on the seating area. If you want to return the backrest to the desired angle, proceed as described at the beginning of backrest angle adjustment.



Video Adjustment of the backrest angle & folding

Optional: On the **LIFT activ**, the back equipment can be additionally equipped with the lumbar joint to reduce the pack size. To **fold down the backrest at the lumbar joint**, pull up the release slider while folding the backrest down towards the front or in the direction of travel (Fig. 17).



Figure 17: Lumbar joint with release slider



Video Folding down the back system back tube with lumbar joint

19.3 Adjustable back & its adjustment options

The "adjustable back and back padding" back system consists of a belt system and back padding. The slack of the backrest can be adapted to the individual requirements via the belts with tensioning loops.

First remove the back padding that has been covered over which has been attached using hook-and-loop straps. The belt system located underneath has been set in the factory that the top and the bottom belts have a slack of approx. 2 cm. The middle belts have been pulled tight for a good lumbar support.



Figure 18: Belt system of the adaptable backrest upholstery with three belts

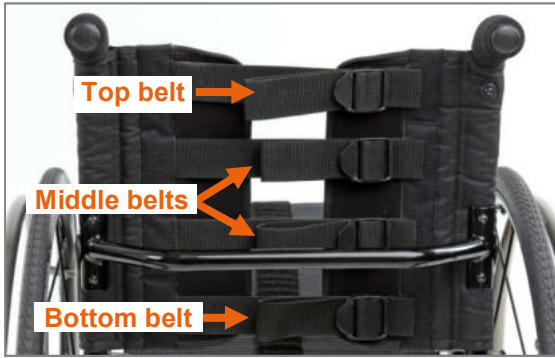

Figure 19: Belt system of the adaptable backrest upholstery with four belts

To **adjust the slack in the belt system**, the tensioning loop of the respective belt is held by its strap and pressed to the right until the belt slackens.



Figure 20: Push the tensioning loop onto its strap on the right



Figure 21: Tensioning loop open completely

Now the belt can be pulled tight for setting a small slack or loosened for a large slack (Fig. 22 and 23). The belt does not have to be threaded out of the tensioning loops for this.



Figure 22: Reduce the slack



Figure 23: Increase the slack

In order to put the tensioning loops back onto the back system loosely again, pull the loop section at the back to the left. You should dose your pulling force with care in order not to adjust the set slack again.



Figure 24: Then re-apply the tensioning loops back on the back system



Figure 25: Tensioning loops applied slightly to the back system

Then reinstall the back padding using the Velcro straps.

If the belt should have mistakenly been threaded out during the adjustment, see the following figures for **threading the belt in correctly**:



Figure 26: Step 1: Threading in the belt



Figure 27: Step 2: Threading in the belt



Figure 28: Step 3: Pulling the belt through



Figure 29: Step 4: Simple threading in of the belt through the tensioning loops

 The belts must always be threaded through the tensioning loops twice as otherwise, the belts will slacken when using the product and with intensive loading, the middle web of the tensioning loops will bend through intensively.

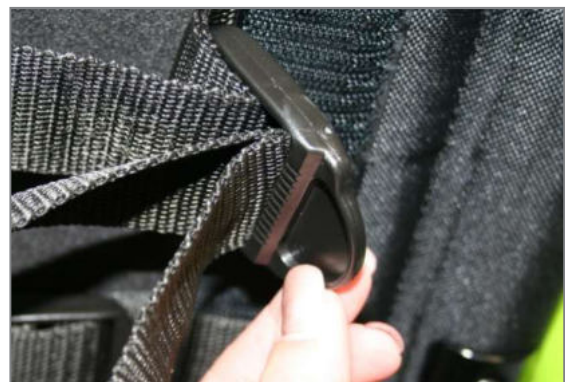

Figure 30: Step 5: Returning the belt through the tensioning loop to obtain the required "double passage"



Figure 31: Step 6: Pulling the belt through for the double passage



Figure 32: Step 7: Double passage



Figure 33: Step 8: Threading in the belt



Figure 34: Step 9: The belt has been fully threaded

19.4 Ergonomic back shell & its setting options

The "ergonomic back shell" back system consists of an aluminium shell, Velcro cross-straps and back padding.

Slack is already integrated into the back shell due to its shape. It cannot be adjusted.

However, **lumbar support** can be adjusted individually using the Velcro cross-straps. For this purpose, the back padding is removed over the Velcro straps. The cross-straps can now be tensioned according to the individual requirements by releasing and refastening the Velcro strap system.



Figure 35: Ergonomic back shell (view from behind)

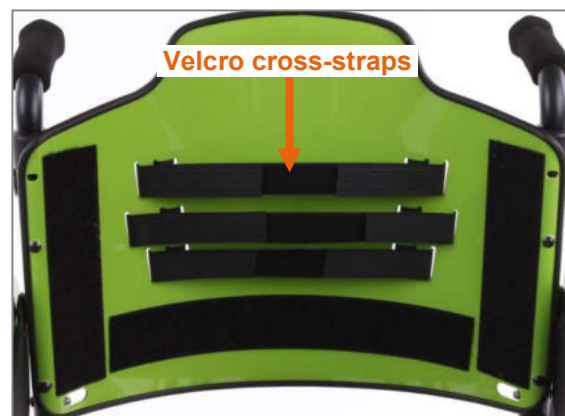

Figure 36: Ergonomic back shell without back padding with Velcro cross-straps (view from the front)

Then mount the back padding using the Velcro straps.

19.5 Ergo Back backrest bar and its adjustment possibilities

The "Ergo Back backrest bar" back system normally consists of a backrest bar (with or without lumbar curvature) and an adjustable backrest upholstery including customised back padding. The adjustment possibilities of the **adjustable backrest upholstery** are described in chapter 19.3.



Figure 37: Ergo Back backrest bar with adjustable backrest upholstery, back padding attached (view from the rear)



Figure 38: Ergo Back backrest bar with adjustable backrest upholstery with four belts, back padding removed (viewed from the rear)

If the Ergo Back backrest bar is fitted with a **back shell** instead of the adjustable backrest upholstery, the adjustment possibilities described in chapter 19.4 apply.



Figure 39: Ergo Back backrest bar with back shell (viewed from the rear)

20 Seat system

 Avoid falling into the seating and backrest upholstery/back shell as it significantly increases the risk of an adjustment, falling down or defects.

The seat system usually consists of either sprung Body Contour seat cover or a belt system. The LIFT solid is additionally equipped with the aluminium seat plate.

With a seating system from **Body Contour seat cover**, there is no adjustment option. The Body Contour seat cover has a springing effect and when seating automatically forms a slack.



Figure 40: Body Contour seat cover

The **belt system** can be subsequently adjusted. Using the fleece hook-and-loop straps, the slack in the seating surface can be changed so that it suits your seat cushion system. In doing so, the seat cover should not have too much slack to avoid touching the frame cross tubes.



Figure 41: Open belt system with fleece hook-and-loop straps for adjusting the slack

The **aluminium seat plate** offers no adjustment options. It is often used as the base for designing individual, anatomically shaped seat systems.



Figure 42: Aluminium seat plate

Note:

Using a seat cushion on the seat system is mandatory. At cold temperatures, the seat cushion prevents lower abdomens from under-cooling and protects against dirt and wetness. Moreover, the cushion ensures uniform pressure distribution for your bottom and absorbs impacts as well as vibrations.

21 Clothing guard

21.1 Overview of terms

21.1.1 Overview for LIFT activ



Figure 43: Clothing guard – LIFT activ

The clothing guard is permanently screwed onto the release handle. It cannot be removed.

21.1.2 Overview for LIFT solid

In the **mechanical** version, a clothing guard is not offered.

In the **electric** version, a plug-in clothing guard between the seat and side section can be selected.



Figure 44: Clothing guard mounted on product (view with drive wheel)

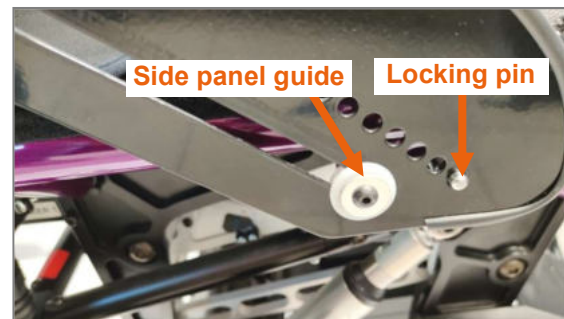

Figure 45: Clothing guard slots



Figure 46: Clothing guard removed from product

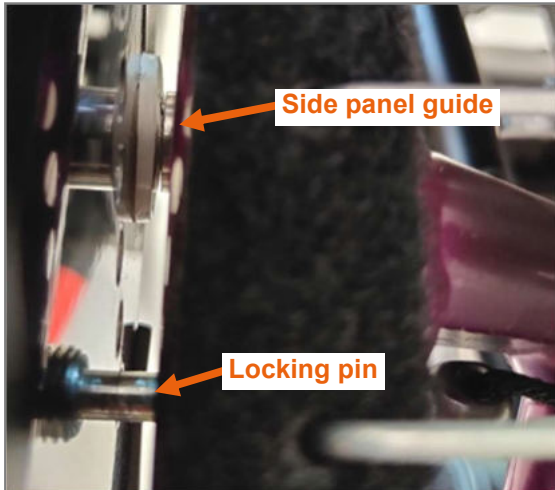

Figure 47: Clothing guard removed, view of the side section from above



Figure 48: Clothing guard resting on side section (view from the side)

21.2 Removing and attaching the clothing guard (LIFT solid)

To **remove the clothing guard**, pull the clothing guard upwards and out.

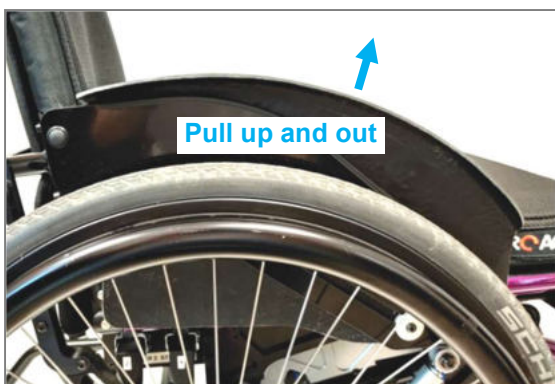

Figure 49: Clothing guard removal

To **attach the clothing guard**, the clothing guard is plugged in. At the front, the clothing guard rests on the recess (Fig. 46) on the side panel guide and the locking pin (Fig. 47). Then press the clothing guard down at the back until it rests on the side section (Fig. 48).

22 Drive wheels

22.1 Removing and attaching the drive wheels

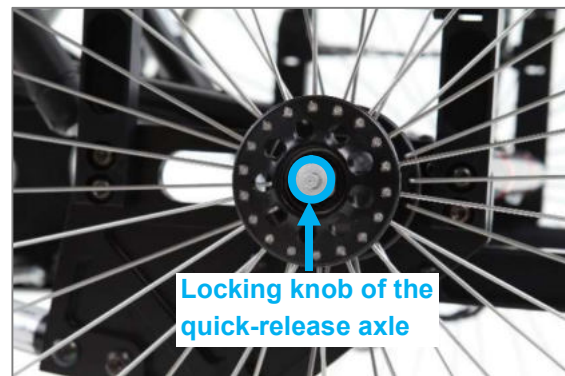

Figure 50: Locking knob of the quick-release axle in the middle of the wheel axle

To **remove the drive wheels** grip through the spokes around the wheel hub with your fingers. The wheels can be unlocked and removed by pressing and holding the locking knob at the centre of the wheel axle with your thumb.

To **attach the drive wheels**, press the locking knobs and insert the drive wheels with quick-release axle into the drive wheel bushings. When doing this, special attention should be paid to ensure that the locking knob springs out again after attaching the wheel, as otherwise the wheels are not properly secured. You will know this if you can see the index groove.

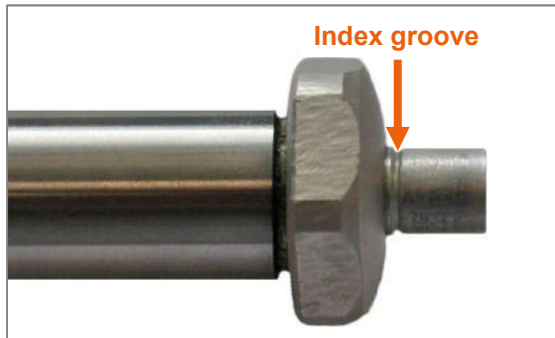

Figure 51: Quick release axle with index groove

The quick-release axle is equipped with the small standard locking knobs (see previous figure) as standard. The **quick-release axle with operation support and large push button** can be equipped as an option. The sequence for removing and attaching the drive wheels is identical with this option.

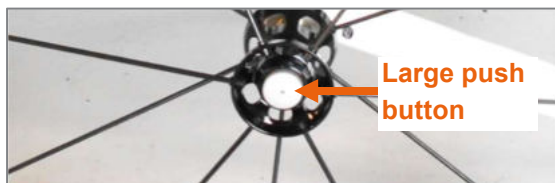

Figure 52: Quick-release axle with operation support, large push button



Before using the product, check if the wheels are secured and that the quick release axles are locked.

Recommended equipment:

For quadriplegics or people with limited finger function, a **Tetra Clip** is available to operate the quick-release axle lock. The Tetra Clip is a plastic housing that is screwed onto the outer side of the drive wheel hub and operated by means of a push-through pin. The pin has a red marking on one side (quick release axle opened) and a green marking on the other side (quick release axle locked). The pin can be pushed using the ball of your hand in the direction of the middle of the drive wheel and thereby the quick release axle opened or closed.

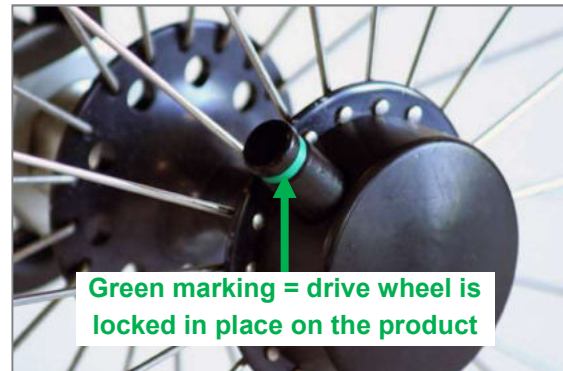

Figure 53: Tetra Clip with locked quick release axle



Figure 54: Tetra Clip with opened quick release axle, drive wheel can be removed

22.2 Checking and adjusting the wheel tracking of the drive wheel



The following instructions are intended for and may only be carried out by a rehabilitation specialist dealer or PROACTIV

Well adjusted wheel tracking significantly improves the easy running characteristics of the product. To **check** the tracking, proceed as follows:

Position the product on a level surface and secure the product against rolling away.

Measure the axle heights (from the ground to the drive wheel axle) and write this dimension onto both tyres at front and back.

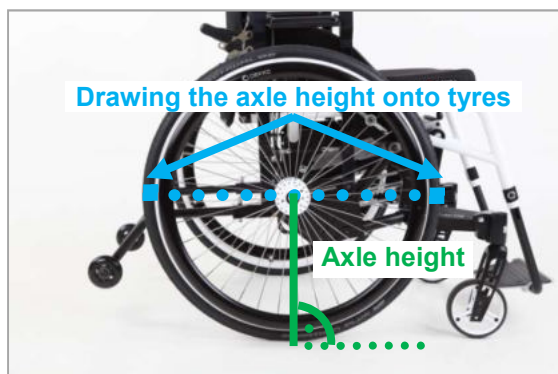

Figure 55: Drawing the axle height on the front and back of both tyres (LIFT solid)

Afterwards measure the distance between the drive wheels front and back at the height of the axles along the markers. Ideally, the distance between the two drive wheels should be the same size at the front and back. In general it can be said that the distance between the drive wheels at the front may not be larger than at the back. Apart from that, the distance at the back may not be more than 5 mm larger than that at the front. If this is not the case, the wheel tracking needs to be corrected.



Figure 56: Distance between the markers on the tyres (at axle height), (view from the rear; LIFT solid)

To **adjust the track** proceed as follows:

1. Loosen the aluminium locking nuts on both sides (AF 41 mm).

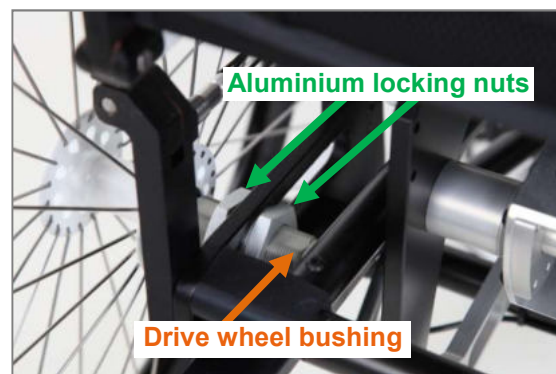

Figure 57: Drive wheel bushing and aluminium locking nut (view from the rear; LIFT solid)

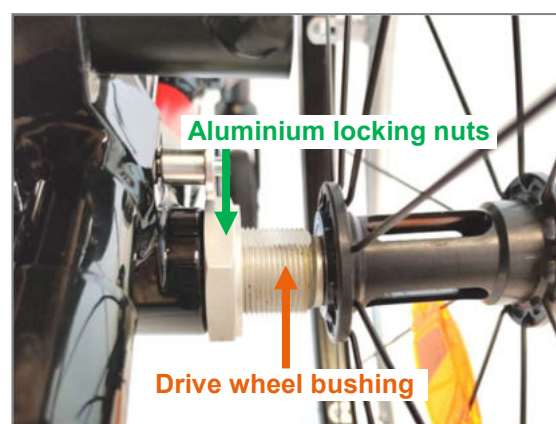

Figure 58: Drive wheel bushing and aluminium locking nut (view from the rear; LIFT activ)

2. Correctly adjust the track by turning the drive wheel bushing (AF 22 mm). Here it can be said that: If you turn the drive wheel bushings in the direction of travel, the track at the front will become narrower. The exact opposite occurs if you turn it opposite to the direction of travel; the track becomes wider.
3. Make sure that the distance at the front to the frame on the right and left is the same.

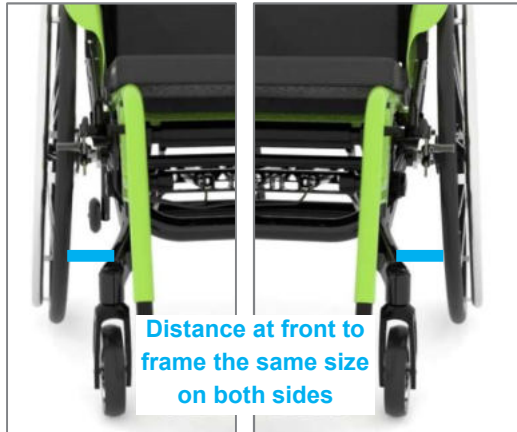

Figure 59: Front distance to the frame (LIFT activ)

4. Measure the distance between the drive wheels at the front and back again at the axle height (along the markers) so that the distance between the drive wheels is not any larger at the front than at the back. Apart from that, the distance at the back may not be more than 5 mm larger than at the front.



Figure 60: Distance between the markers on the tyres (at axle height), (view from the rear; LIFT solid)

5. If all the distances are correct, then use an open-ended spanner (AF 22 mm) to hold the running wheel bushing in position and tighten the aluminium locking nut (AF 41 mm) with a tightening torque of 70 Nm.

22.3 Wheel camber

The following instructions are intended for and may only be carried out by a rehabilitation specialist dealer or PROACTIV

The wheel camber increases the lateral stability of the product but also increases the overall width of the product.

The wheel camber will be configured as ordered and can be subsequently changed by replacing the drive wheel bearings (with integrated wheel camber). If you would like to change the camber, contact your rehabilitation specialist dealer or PROACTIV.

22.4 Tyre pressure

Check the tyre inflation pressure at regular intervals as well as after extreme influence of temperature (not on solid rubber tyres). The **maximum and if applicable, minimum tyre pressure is printed on the side of the tyre**. This should be observed.

If the tyre pressure is too low, the optimum functional capability of the knee lever brake and the integral brake is not guaranteed, and an excessively low tyre pressure influences the driving behaviour negatively. Apart from that, there is an increased risk of a flat tyre.

The tyre pressure increases with the temperature. If the pressure is too high, the tyre may burst. For this reason, product tyres may not be exposed to unusually high temperatures such as in a sauna or under glass in the summer.

When inflating the tyres, make sure that the prescribed air pressure is not exceeded.

To check or correct the tyre pressure, proceed as follows:

1. Secure the product to prevent it rolling away.
2. The drive wheel is normally fitted with a car tyre valve. Unscrew the valve cap.



Figure 61: Valve with cap

3. Place the valve attachment of the compressed air device or the compressor onto the valve (if necessary, an adapter must be placed on the valve attachment) and, if a clamp lever is fitted, secure the connection by applying the lever.
4. Now check the tyre pressure. If the tyre pressure does not match the specifications, correct it.
5. Finally release the clamp lever (if present), pull the valve attachment off the valve and replace the valve cap.



Figure 62: Compressor

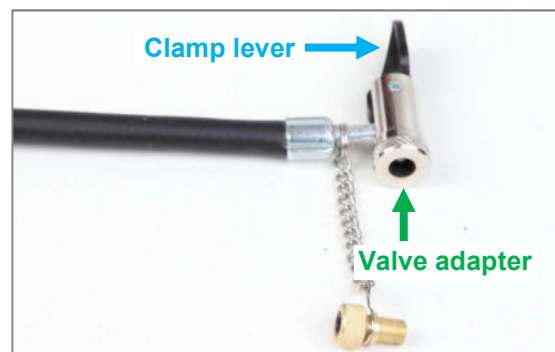

Figure 63: Valve adapter and clamp lever of the compressor

22.5 Other

If tyres, inner tubes or handrims need to be replaced, please contact your rehabilitation specialist retailer.

Recommended equipment:

The spoke guard prevents hands and fingers entering and being trapped in the wheels when riding. The risk of injury is thus minimised.

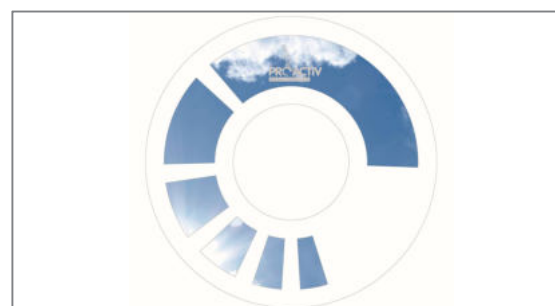



Figure 64: Spoke guard for minimising the risk of hands and fingers getting trapped

23 Caster wheels

23.1 Replacing the caster wheels

 The following instructions are intended for and may only be carried out by a rehabilitation specialist dealer or PROACTIV

The caster wheels of the product are, depending on the type of casters, either fastened with two M6 axle fixing screws or one M6 axle fixing screw and a M6 nut.

23.1.1 Replacing the caster wheels when mounted using two axle fixing screws

To **remove a caster wheel**, unscrew the M6 axle fixing screws (AF 4 mm) on one side.



Figure 65: M6 axle fixing screw of caster wheel axle (view from outer side of product)



Figure 66: Caster wheel with aluminium hexagon socket

Now you can see the aluminium axle with a hexagon socket (AF 4 mm) in the middle of the axle. This hexagon socket is used to fix the axle in place, while the second M6 axle fixing screw (AF 4 mm) is unscrewed. To do this, insert an Allen key (AF 4 mm) into the hexagon socket on the aluminium axle and hold it still. At the same time, unscrew the remaining M6 axle fixing screw (AF 4 mm) on the other side.

Now the caster wheel can be removed from the fork. One spacer each is mounted to the right and left on the caster wheel that you are

able to remove in order for it to be reused later when reinstalling the new caster wheel. If you want to install a different type of caster wheel, use the enclosed spacers, as these generally differ depending on the type of caster wheel.



Figure 67: Spacer on the caster wheel

To **mount the caster wheel**, proceed in the reverse order as for removal. Please make sure that the spacers on the right and left on the caster wheel are re-installed in the caster fork before assembly. The torque of the M6 axle fixing screws (AF 4 mm) is 7 Nm. It is recommended only to use screws with polymer dry locking coating. Screws without polymer dry locking coating must be secured with thread-locking fluid.

23.1.2 Replacing the caster wheels when mounted using an axle fixing screw and nut

To **remove the caster wheel**, hold the M6 nut (AF 10 mm) firmly and loosen the M6 axle fixing screw (AF 4 mm). Now you can remove the M6 nut and washer, the M6 axle fixing screw with washer and the caster wheel.



Figure 68: M6 axle fixing screw of caster wheel axle (view from outer side of product)



Figure 69: M6 caster wheel axle nut (view from inner side of product)



Figure 70: Caster wheel with aluminium axle



Figure 71: Spacer on the caster wheel

When **mounting the caster wheel**, position the caster wheel with its spacers in the caster wheel fork, hold it in position and insert the M6 axle fixing screw with its washer from the outside of the product to the inside through the axle of the caster wheel. Now attach the washer and the M6 nut (AF 10 mm) from the other side. The tightening torque of the axle fixing screws (AF 4 mm) is 7 Nm.

23.2 Caster wheels flapping

Uncontrolled swivelling backwards and forwards of the caster wheels around their axes on the caster fork (while moving) is known as "fluttering".

 If the caster wheels start to flutter, immediately reduce your speed to prevent the caster wheels from jamming sideways and therefore reduce your risk of falling.

The **speed limit** where caster wheel fluttering starts, **is reduced by**:

- increasing size of the caster wheels
- increase weight of the caster wheels
- falling load on the caster wheels
- decreasing caster length of caster wheels

The following options are available with the LIFT solid to **counteract caster wheel fluttering in general**:

- Fluttering can be reduced by **reducing the caster wheel diameter**. This means installing a small caster wheel in a different wheel position in the caster fork (seat height therefore does not change) would be one way of reducing fluttering. However, please note that using a smaller caster wheel makes it more difficult to overcome obstacles and makes tipping necessary more often. The smaller the caster wheel is, the more driving skill is required.
- Another option for reducing fluttering is to use a **lighter caster wheel with the same diameter** or, as described above, **with a smaller diameter**.

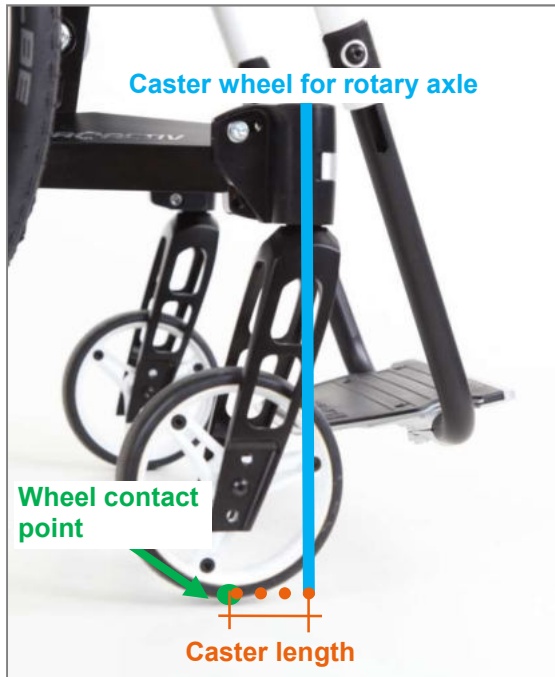

Figure 72: Caster length

- It is also possible to **increase the caster length**. The caster length is the distance between the rotary axle of the caster fork projected onto the floor and the wheel contact point. The wheel contact point of the caster wheel trails behind the rotary axle as it were. The caster length has a stabilizing effect on moving in a straight line. Increasing the caster length can be achieved by mounting the caster wheel in a different wheel position on the caster fork (in doing so, the front seat height or the angle of the seat changes; see Chapter 18.2). Another possibility is to bend the caster wheel axle (see Chapter 23.4) forwards in the direction of travel in the lower area. The angle of the caster wheel axle can be adjusted up to approximately 4 mm over the length of the caster wheel bearing block out of the vertical. This increases the caster length and the tendency to vibrate reduces.

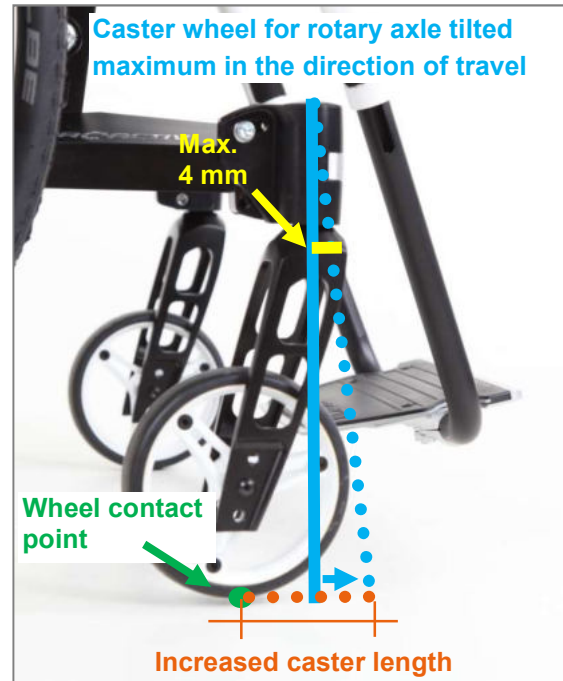



Figure 73: Increased caster length via the inclination of the caster wheel axle

23.3 Replacing the caster forks

A distinction needs to be made between the caster forks with a screwed axle and those with a quick-release axle.

23.3.1 Caster fork with screw-on axle on angle-adjustable caster-wheel bearing blocks (LIFT solid)

 The following instructions are intended for and may only be carried out by a rehabilitation specialist dealer or PROACTIV

To **remove the caster fork with screwed axle**, first the aluminium cap on the caster wheel bearing block must be removed. In order to release the cap, you can run under the cap using a commercially available cutter knife and lift slightly at several points. Then the M12 nut (AF 19 mm) is loosened using, e.g. an AF 19 mm socket. Now the caster wheel for rotary axle can be pulled out from under the caster wheel bearing block.



Figure 74: Aluminium cap



Figure 75: Aluminium cap removed and M12 nut visible

To **assemble the caster fork with screwed axle**, this is inserted into the caster wheel bearing block with the caster wheel for rotary axle. Then the M12 nut (AF 19 mm) is tightened again to 3 Nm and secured with thread-locking fluid. Then the aluminium cap is pressed back onto the caster wheel bearing block.

For the rotary axle to run smoothly, the M12 nut must not be tightened to more than 3 Nm. In case more sluggishness is desired, this can be achieved using a higher tightening torque.

23.3.2 Caster fork with screw-on axle with welded caster wheel bearing blocks

 The following instructions are intended for and may only be carried out by a rehabilitation specialist dealer or PROACTIV

To **remove the caster fork** with screw-on axle, a wrench is used which is included in the scope of delivery. This wrench is inserted into the two holes on the nut of the caster wheel bearing block and turned anti-clockwise, e.g. using an AF 24 mm fork wrench. The caster fork needs to be held still. When the nut has been completely removed, the caster fork can be pulled out.

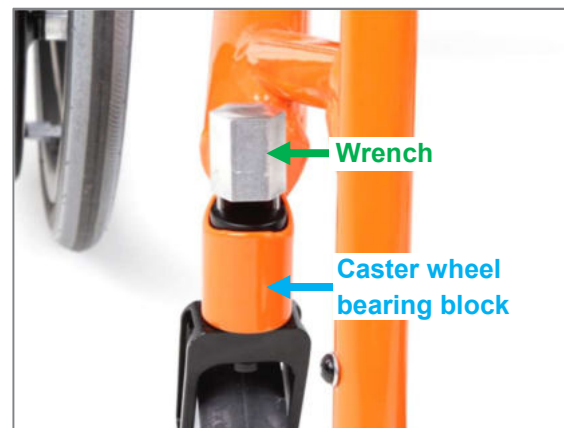

Figure 76: Loosen the nut of the caster wheel axle using the wrench

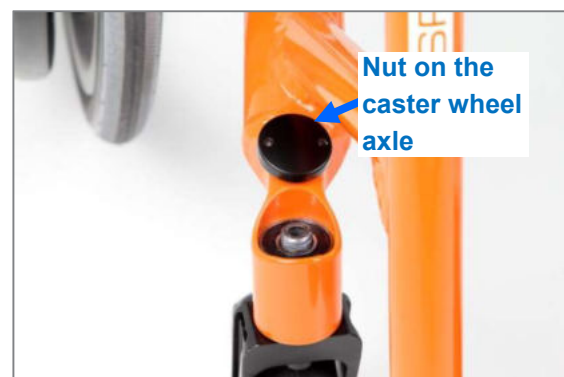

Figure 77: Caster wheel axle nut completely removed

When **mounting the caster wheel fork** with screw-on axle, insert the caster wheel axle back into the caster wheel bearing block, use the supplied wrench to tighten up the nut of the caster wheel axle again (hold the caster wheel axle firmly) and secure it with thread lock.

The nut of the caster wheel axle may not be tightened by more than 3 Nm to ensure it runs smoothly. In case more sluggishness is desired, this can be achieved using a higher tightening torque.

23.3.3 Caster forks with quick-release axles

The **caster fork with quick release axle is removed** using the locking knob on the inner side of the caster fork. Grasp around the caster fork and press the locking knob with your thumb. The caster fork can now be pulled out.

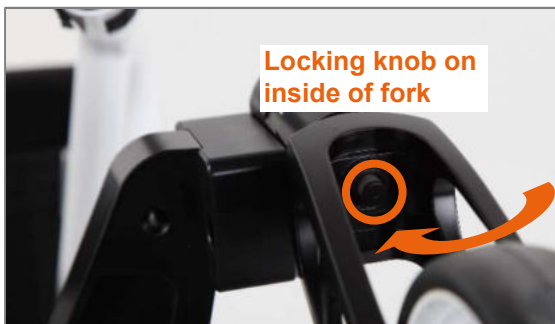



Figure 78: Caster fork with quick-release axle and locking knob

When **assembling the caster fork with quick-release axle**, press the locking knob again and insert the caster fork rotary axle into the caster wheel bearing block. When doing this, particular attention must be paid to ensuring that the locking knob springs all the way out again after attaching the fork, as the forks are otherwise not secured correctly. You will know that if you can see the index groove (Fig. 51).

23.4 Adjustment of the caster fork rotary axes (LIFT solid)

 *The following instructions are intended for and may only be carried out by a rehabilitation specialist dealer or PROACTIV*

To ensure that the product has good properties when steering and driving straight ahead, the caster wheel axle should be adjusted to be vertical to the level ground.

Adjustments on the caster wheel axles can be required for the following reasons:

- The tipping point and/or seat heights have been changed.
- The caster wheel axles are no longer vertical due to a fall or an impact.
- The flatter of the caster wheels should be reduced.

To adjust the caster fork rotary axes, the product should be standing on a level surface and the wheel track of the drive wheels should have already been adjusted (Chapter 22.2).

Now **check** whether the caster fork rotary axes are positioned perpendicular to the level ground. For this purpose, place an angle with height adjustable slider on the front edge of the caster wheel bearing blocks. The slider should be aligned at the middle of the caster wheel bearing block.

Information:

If the front edges of the caster wheel bearing blocks are perpendicular to the level ground, the caster fork rotary axes are as well.

Observe that the front edges of the caster wheel bearing blocks are slightly rounded. Thus, the distance above and below between the slider of the angle and the front edge of the caster wheel bearing blocks must be the same size.

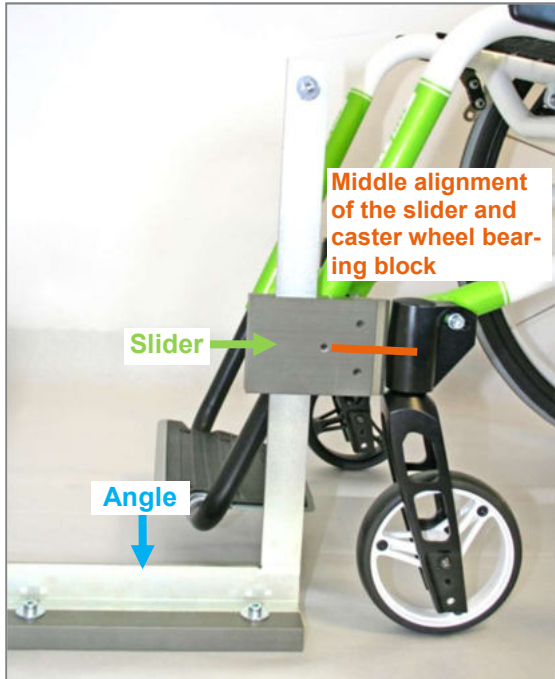

Figure 79: Checking the adjustment of the caster wheel axles

Tool recommendation:

The angle with slider can be ordered from PROACTIV (order number: 8000 901 000).

If the front edges of the caster wheel bearing blocks are not standing vertical to the level ground, the settings must be adjusted. First, **adjust** the right caster wheel bearing block, then the left one, and finally check the right side again. To do this, proceed as follows:

1. Loosen the M5 stud bolt (AF 2.5 mm).



Figure 80: Stud bolt

2. Undo the M6 fixing screw (AF 5 mm) slightly on the frame inner side.



Figure 81: M6 fixing screw on frame inner side, washer fitted with G-shape frames but not V-shape frames

3. Now slightly loosen the M6 fixing screw (AF 5 mm) on the outside of the frame.



Figure 82: M6 fixing screw on the frame outer side with washer

4. Using the aid of the angle, move the caster wheel bearing block in a vertical position to the level ground.
5. Tighten the M6 fixing screws (AF 5 mm) again on the frame outer and inner side to a tightening torque of 10 Nm and recheck the vertical setting.
6. Screw the M5 stub bolt (AF 2.5 mm) back in so that this rests on the M6 fixing screw.

 After performing adjustment work on the caster wheel bearing block twice, renewing the screw locking fluid for the M6 fixing screws (AF 5 mm) on the outer and inner sides of the frame is recommended.

Note:

To reduce caster wheel flutter, it may be necessary to tilt the caster fork rotary axles from the vertical (Chapter 23.4).

24 Footrests

 Make sure the ground clearance under the footrest is sufficient. Experience shows that this should not be less than 4 cm. This must be observed for the angle adjustment of the footplate support and when setting the lower leg length.

24.1 Angle adjustment of the footplate support

 *The following instructions are intended for and may only be carried out by a rehabilitation specialist dealer or PROACTIV*

The **angle** of the **footplate support** can be set by releasing the M6 fastening clamp screws (AF 5 mm) on the lower side of the footrest support plate. When the angle adjustment is completed, tighten the M6 fastening clamp screws (AF 5 mm) again to maximum 5 Nm. This tightening torque should not be exceeded as higher tightening torques can damage the clamp.

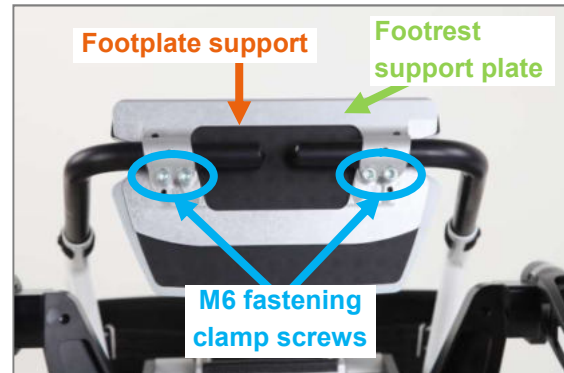

Figure 83: Footrest from below

24.2 Footrest continuous



Figure 84: Footrest continuous

For the **longitudinal setting of the footrest support tubes or adaptation to the lower leg length**, the M6 fixing screws (AF 4 mm) must be undone on both sides on the outside of the frame tube. The footrest support tubes are then pushed along their slots and thus brought into the correct position. Observe that the footrest support tubes are both the same length on both sides after they have been adjusted.

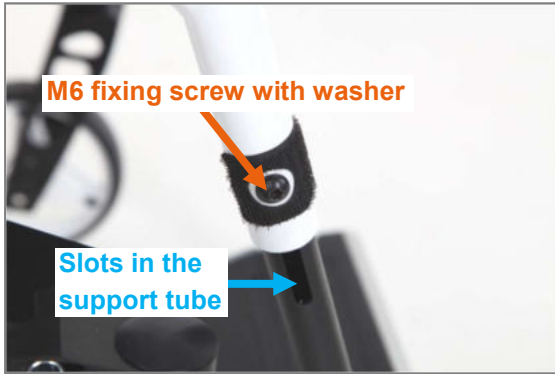

Figure 85: M6 fixing screw with washer and slot in footrest support tube for adjusting the lower leg length

Once the position has been set, fix the footrest support tubes by tightening the M6 fixing screws (AF 4 mm) with washers to 7 Nm on both sides.

Note:

With a V-shaped product frame or with a larger lower leg width at the top than the bottom, it is necessary to relieve the footrest support tube tension in the footrest support plate resulting from longitudinal adjustment. In this case, the M6 fastening clamp screws (AF 5 mm) on the footrest support plate therefore have to be opened before starting to adjust the lower leg length. View the procedure in chapter 24.1.

24.3 Footrest fold up to the rear



Figure 86: Footrest, fold up to the rear, in standard position

To **fold up the footrest to the rear**, move the locking pin lever on the right and left side to the vertical position to the footbar joints. Now you can move the footrests to the rear.

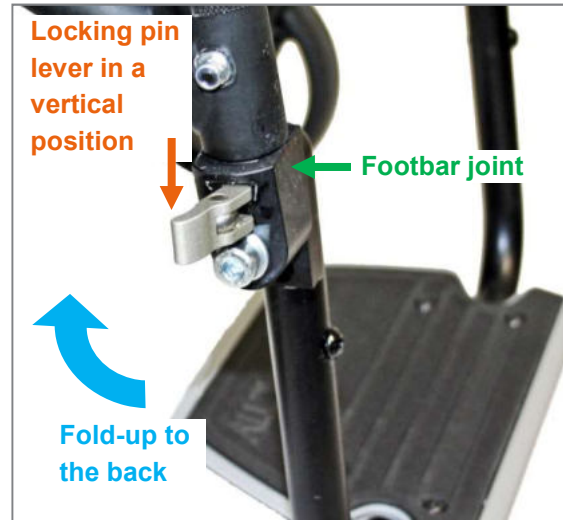

Figure 87: Locking pin lever in a vertical position to the footbar joint, opened

If the footrest should engage in the folded up position, move the locking pin lever back to the horizontal position to the footbar joint. The locking pin levers are now not resting against the footbar joints as the locking pins are not engaged in the locking position yet.



Figure 88: Locking pin lever in horizontal position, not engaged and thus not resting against the footbar joint

As soon as an engaged position is reached during the return movement, the locking pins engage and the levers rest against the footbar joint.



Figure 89: Locking pin lever in horizontal position, engaged and thus resting against the footbar joint

If you want to move the footrest back into the standard position, perform the as previously described and during this process, move the footrest to the front.

After "folding up to the back" each time, make sure that the footrest has engaged correctly again. This is visible when the locking pin lever rests against the footbar joints (Fig. 89).



Video Folding away the footrest to the rear

To **adjust the length of the footrest support tubes or adapt the lower leg length**, the M6 fixing screws (AF 4 mm) on the front sides of the frame tubes must be released on both sides. Fix the footrest support tubes to the inlets using the M6 fixing screws (AF 4 mm) that have 3 holes that serve the setting of the lower leg length. Only an extension of the lower leg length is possible as the footrest support tube is always fixed in the top hole of the inlet.



Figure 90: M6 fixing screw with washer to adjust the lower leg length



Figure 91: Inlet with 3 holes (view without footrest support tube)

Once the M6 fixing screws (AF 4 mm) have been loosened on both sides, move the footrest support tubes so that the holes on both sides of the footrest support tubes are positioned accurately over the holes of the underneath positioned inlet. Take care that the same holes are used on both sides.

Once the position has been set, fix the footrest support tubes by tightening the M6 fixing screws (AF 4 mm) with washers to 11 Nm on both sides.

24.4 Footrest fold up to the rear with spring locking mechanism

This version is not possible for the electric LIFT solid.



Figure 92: Footrest, folding up to the rear, with spring latching mechanism, in standard position

To **fold the footrest up to the rear**, the footplate must be pushed gently backwards until the footrest is released from the lock. Now the footrest can be folded up completely to the rear.

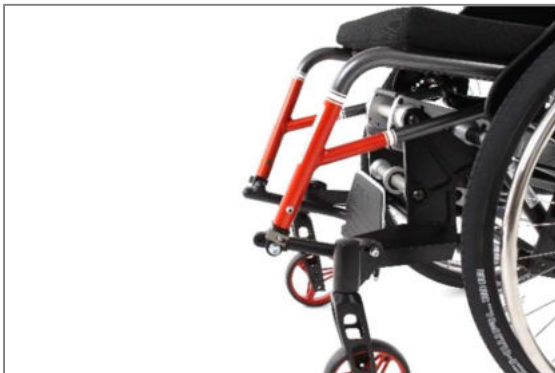

Figure 93: Footrest, folding up to the rear, with spring latching mechanism, folded up to the rear

If you want to return the footrest to the standard position again, push it back forwards to the standard position.

To **adjust the length of the footrest support tubes or adapt the lower leg length**, the M6 fastening clamp screws (with polymer dry locking coating, AF 4 mm) must be unscrewed on both outer sides of the lower leg tubes. The lower leg length can now be adjusted along the notches. Make sure that the same notch is used on both sides.

A large adjustment range is available for a shorter lower leg length. If a longer lower leg length is desired, it can usually be extended by

2 cm with the existing lower leg tube. If a larger extension is required, longer lower leg tubes can be ordered.

Once the lower leg length is adjusted, fix it in position by inserting the M6 fixing screws (with polymer dry locking coating, AF 4 mm) on both sides and tightening them to 7 Nm.

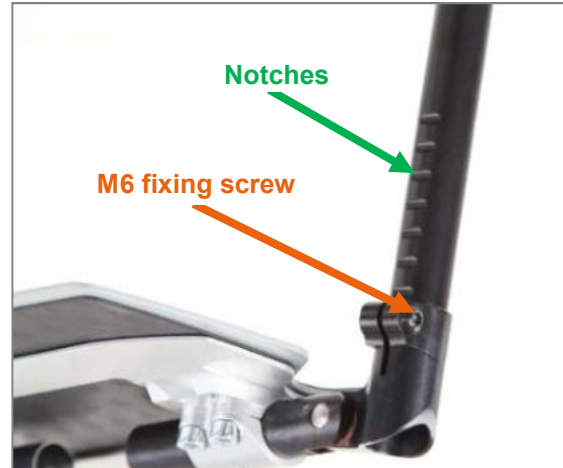

Figure 94: Notches and M6 fixing screw for lower leg length adjustment (view from the rear)

Note:

With a V-shaped product frame or with a larger lower leg width at the top than the bottom and footrest support tubes that do not run parallel, it is necessary to footrest plate the footrest support tube tension in the footrest support plate resulting from longitudinal adjustment. In this case, the M6 fastening clamp screws (AF 5 mm) on the footrest plate support therefore have to be opened before starting to adjust the lower leg length. The procedure can be found in chapter 24.1.

24.5 Divided footrest



Figure 95: Divided footrest, standard position

To **fold up** one of the two footrest parts, grasp it and fold it up to the side. Moreover, you can also **turn or pivot the footplate support outwards**.

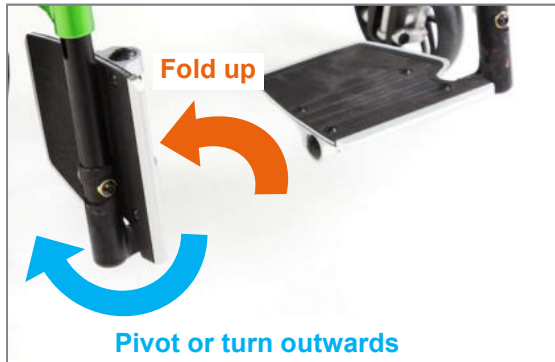

Figure 96: One footrest folded up, option for pivoting outwards marked

For the **longitudinal setting of the footrest support tubes or adaptation to the lower leg length**, the M6 fixing screws (AF 10 mm) must be undone on both sides on the outside of the frame tube. The footrest support tubes are then pushed along their slots and thus brought into the correct position. Observe that the footrest support tubes are both the same length on both sides after they have been adjusted.



Figure 97: M6 fixing screw with washer and slot in footrest support tube for adjusting the lower leg length

Once the position has been set, fix the footrest support tubes by tightening the M6 fixing screws (AF 10 mm) with washers to 7 Nm on both sides.

Note:

With a V-shaped product frame or with a larger lower leg width at the top than the bottom, it is necessary to correct the resulting, shifted position of the footplate supports. The footplate support plates can be moved back to the correct position by opening the M6 fastening clamp screws (AF 5 mm) on the footrest support plates. View the procedure in chapter 24.1.

24.6 Removable frame stem, foldable with divided footrest

This footrest is suitable for wheelchair users who also want to use the LIFT as a stand-up aid and for moving forward with their feet while in a sitting position. It can be swivelled in or out and can also be removed.



Figure 98: Removable frame stem, foldable, with divided footrest



Figure 99: Removed footrest

Installing the footrest:

1. Insert the pintle (Fig. 99) into the support tube, whereby the footrest is pointing 90° outwards.
2. Then swivel the footrest inwards until it engages.

Removing the footrest:

1. Pull the release lever against the direction of travel (Fig. 98).
2. Now swivel the footrest outwards by 90°.
3. Then pull out the footrest upwards.

For the **longitudinal setting of the footrest support tubes or adaptation to the lower leg length**, the M6 fixing screws (AF 10 mm) must be undone on both sides on the outside of the frame tube. The footrest support tubes are then pushed along their slots and thus brought into the correct position. Observe that the footrest support tubes are both the same length on both sides after they have been adjusted.



Figure 100: M6 fixing screw with washer and slot in footrest support tube for adjusting the lower leg length

Once the position has been set, fix the footrest support tubes by tightening the M6 fixing screws (AF 10 mm) with washers to 7 Nm on both sides.

Note:

With a V-shaped product frame or with a larger lower leg width at the top than the bottom, it is necessary to correct the resulting, shifted position of the footplate supports. The footplate support plates can be moved back to the correct position by opening the M6 fastening clamp screws (AF 5 mm) on the footrest support plates. View the procedure in chapter 24.1.



Video Removing and installing the removable frame stem, foldable with divided footrest

24.7 Swing away footrest (LIFT solid)



Figure 101: Swing away footrest, in standard position

To **fold up**, grab one of the two footrest parts and fold it up to the side. Moreover, you can also turn or pivot the footrest outwards.



Figure 102: Both footrest parts folded up and pivoted outwards

To **remove** the footrest parts, place the locking pin lever vertical to the bracket towards the front on both sides and then pull both footrest parts upwards out of the bracket.

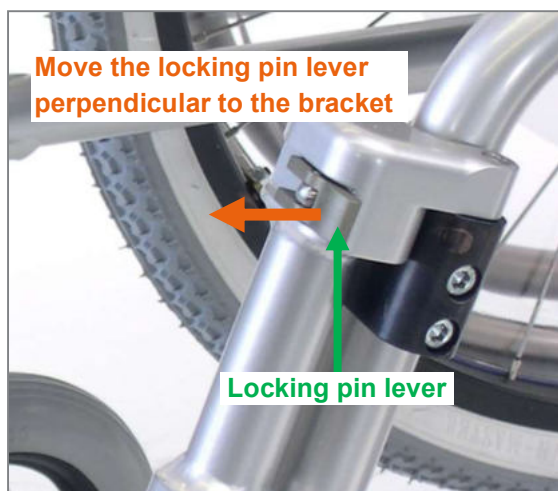

Figure 103: Moving locking pin lever perpendicular to remove swing away footrest



Figure 104: Swing away footrest removed

To **adjust the length of the footrest support tubes or adapt the lower leg length**, the M6 fixing screws (AF 4 mm) must be released on both sides. The footrest support tubes are then pushed along their slots and thus brought into the correct position. Observe that the footrest support tubes are both the same length on both sides after they have been adjusted.



Figure 105: M6 fixing screw with washer to adjust the lower leg length

Once the position has been set, fix the footrest support tubes by tightening the M6 fixing screws (AF 4 mm) with washers to 7 Nm on both sides.

24.8 Safety instructions

 Ensure when setting the lower leg length, that no strong pressure is produced between the underneath of the lower leg of the wheelchair user and the edge of the seating system.

25 Anti-tipping support

To reduce the risk of tipping backwards unintentionally to a minimum, anti-tipping supports are available as accessories. The anti-tipping supports are inserted in the bottom frame tubes which secures them against twisting.

25.1 LIFT activ

25.1.1 Overview of terms

The anti-tipping support is fixed on the lower frame with a quick pin and can be swivelled up using a spring system.

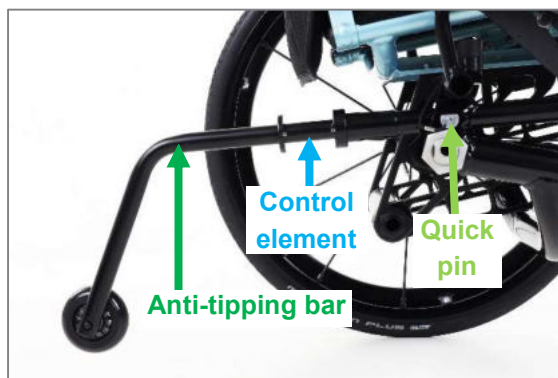

Figure 106: Anti-tipping support with quick pin

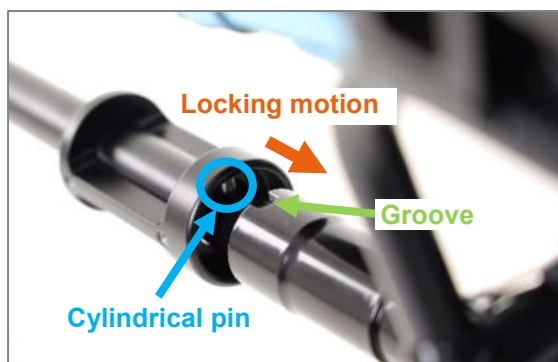

Figure 107: Anti-tipping support lock



Figure 108: Quick pin with locking knob

25.1.2 Operating and passive position

Via a spring system, the anti-tipping supports can be swivelled **from the operating to the passive position**, for example to overcome obstacles, so that they cannot rest on the obstacle.

To move the anti-tipping support into the passive position, pull them each by the control element (Fig. 106) to the rear and out of the frame tubes until the cylindrical pin protrudes from the grooves, and then turn them by 180° upwards/inwards so that the anti-tipping wheel points upwards (Fig. 109). After releasing the anti-tippers, the cylindrical pin slots into the groove again.

Note:

To make it easier, the anti-tipping support can first be turned inwards and up by 90° until it engages. When it engages, you can adjust your grip for the next 90° rotation.

After passing the obstacle, move the anti-tipping supports back **from the passive to the operating position** following the same procedure (Fig. 110). Make sure that these have clicked back into place again properly.



Figure 109: Passive position of anti-tipping support (view from the side)



Figure 110: Operating position of anti-tipping support (view from the side)



Video Adjusting the anti-tipping support in operating and passive position

Note:



The following instructions are intended for and may only be carried out by a rehabilitation specialist dealer or PROACTIV

If handling by **turning inwards** for adjusting the anti-tipping support in operating or passive position does not work for you, it can be changed to **turning outwards**. To do so, proceed as follows:

1. Remove the anti-tipping support as shown in chapter 25.3.
2. Pull the upper end piece upwards until the cylindrical pin abuts (Fig. 111).
3. Rotate the upper end piece by 180° along the guide up to the end (Fig. 112).
4. At the end, let go of the upper end piece so that the cylindrical pin can engage in the groove (Fig. 113).
5. Reinstall the anti-tipping support as shown in chapter 25.3.

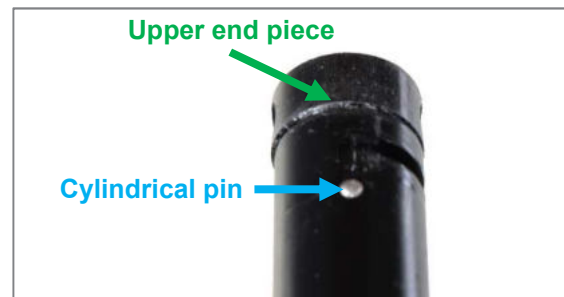

Figure 111: Turning setting for anti-tipping support

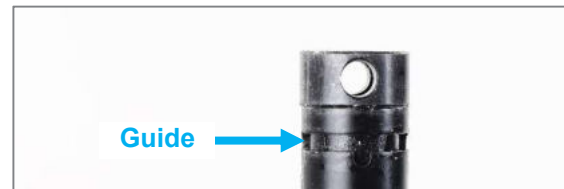

Figure 112: Turning setting for anti-tipping support with guide



Figure 113: Turning setting for anti-tipping support with groove

25.2 LIFT solid

25.2.1 Overview of terms

The anti-tipping support is fixed on the lower frame with a quick pin, which can also be used to remove it.



Figure 114: Operating position of anti-tipping support (view from the rear)



Figure 115: Anti-tipping support with quick pin (view from the rear)

25.2.2 Operating and passive position

To overcome an obstacle, the anti-tipping supports must be moved from the operating to the passive position so that they do not knock against the obstacle.

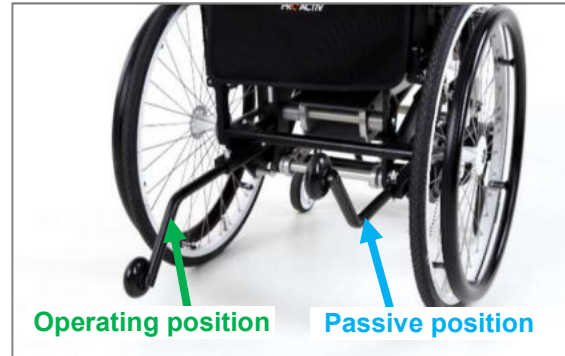

Figure 116: Operating and passive position of anti-tipping support (view from the rear)

To move the anti-tipping support into the passive position, press and hold the locking knob and remove the quick pin (Fig. 117).

Now turn the anti-tipping support by 180° inwards and up, so that the anti-tipping wheel is pointing upwards (Fig. 116). Make sure that the respective holes are aligned. Then press and hold the locking knob and insert the quick pin back into the holes (Fig. 115).

After passing the obstacle, move the anti-tipping supports back **from the passive to the operating position** following the same procedure (Fig. 116). Make sure that these have clicked back into place again properly.

25.3 Removing and attaching the anti-tipping support

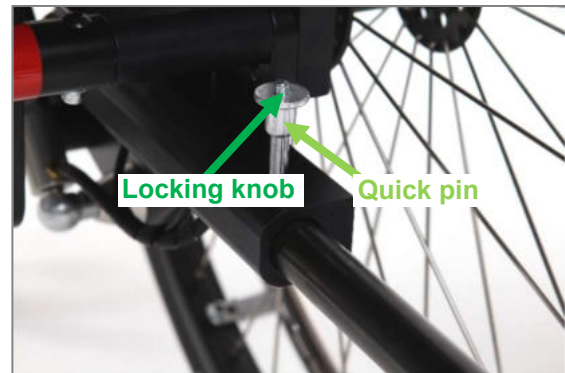

Figure 117: Anti-tipping support with quick pin almost completely pulled out (LIFT solid)

To transport the product, the anti-tipping support can be removed. It must be properly reinstalled afterwards.

Removing the anti-tipping support:

1. Take off the drive wheel (Chapter 22.1; **only necessary on the LIFT activ**).
2. Press and hold the locking knob and remove the quick pin (Fig. 117).
3. Pull the anti-tipping support out of the anti-tipping support sleeve or anti-tipping support mount (Fig. 108 and 115).

Note: To avoid losing the quick pin, it can be reinserted in the anti-tipping support sleeve or mount.

Installing the anti-tipping support:

1. Take off the drive wheel (Chapter 22.1; **only necessary on the LIFT activ**).
2. Pull the quick pin out of the anti-tipping support sleeve or anti-tipping support mount (Fig. 108 and 115).
3. Slide the anti-tipping support into the anti-tipping support sleeve or mount. Make sure that the respective holes are aligned.
4. Insert the quick pin into the hole.
5. The cylindrical pin (Fig. 107) must engage in the groove in the anti-tipping support sleeve (**LIFT activ**).

25.4 Safety instructions

The anti-tipping support has been designed exclusively to minimize the risk of tipping over backwards. It is not suitable for reducing the risk of tipping forwards or to the side. There is no safety equipment on offer for minimizing these risks. For this reason, handling these risks need to be learnt in cooperation with your therapists and doctors.

Before using the product, each time after loading the anti-tipping supports and after every adjustment to the product, make sure that the anti-tipping supports are fully functional. In this case, it must not be possible to swivel the anti-tipping supports to the side when in operating position without having to unlock them first.

The lower edge of the anti-tipping wheels may not be more than 5 cm from the ground. If a larger gap is required or necessary, then you need to work with your therapists and doctors to practice and learn to handle the increased risk of tipping.

If the functional capability of the anti-tipping supports is no longer ensured or if you are in any doubt about their To do function, have them checked by your rehabilitation specialist dealer and repaired before any further use. Otherwise there is an increased risk of falling of getting injured.

26 Brakes

26.1 Knee lever brake

26.1.1 Opening and closing the brake

The knee lever brake can be equipped with various brake levers, such as, e.g. standard brake levers, long brake levers, fold-down brake levers and brake levers with plastic balls. The knee lever brake can also be selected with one-hand operation, in which case only one brake lever is present on the right or left. However, operation is identical for all of these brake levers.



Figure 118: Knee lever brake system with standard brake lever

The **brake is closed** by pushing the brake lever forwards and downwards. In the closed position, the brake pin pushes the tyre in by approx. 4 mm (at the specified air pressure in the tyre).

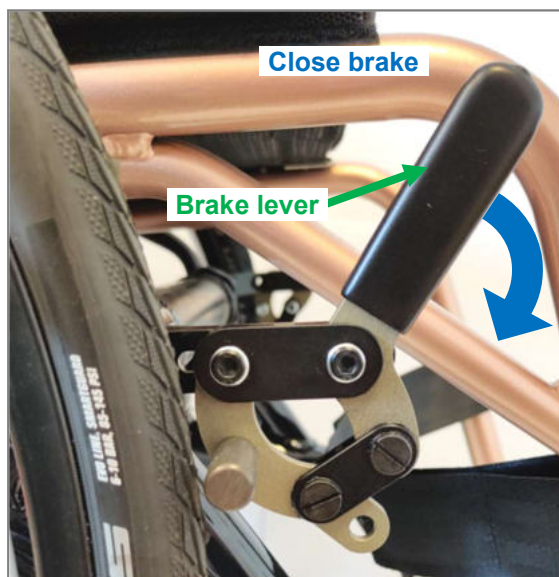



Figure 119: Brake opened, closed by pushing the brake lever forwards and downwards

 Please note that the knee lever brake is a parking brake which may only be applied when the product is at a standstill. This is not a service brake which is suitable for reducing speed.

To **open the brake**, pull the brake lever back up and rearwards again. In the open position, the distance between the brake pin and the tyre is approx. 3 to maximum of 4 mm.

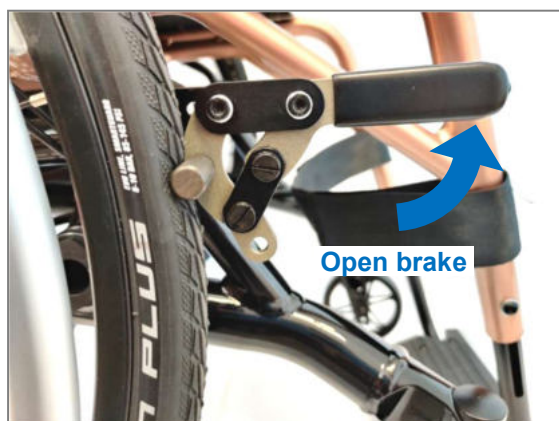



Figure 120: Brake closed; opening done by pulling the brake lever up and rearwards

26.1.2 Setting the brake in a low position & installed at the rear (LIFT solid) & installed at the front (LIFT activ)

 The following instructions are intended for and may only be carried out by a rehabilitation specialist dealer or PROACTIV

Settings on the brake could be necessary for the following reasons:

- You have changed the tyre or the tyre pressure.
- You have changed the wheel tracking or the position of the drive wheels.
- The brake is pulling unevenly or insufficiently after extended use.

To adjust the knee lever brake, proceed as follows on both sides:

1. Initial situation: Drive wheels mounted on the product and the knee lever brakes open. The drive wheels have the specified inflation pressure.
2. For the **correct positioning** of the knee lever brake, slightly loosen the M5 fixing screws (AF 4 mm) so that the knee lever brake can be moved on the brake holding rail.



Figure 121: Sliding directions (LIFT activ; view from the inside of the wheelchair)

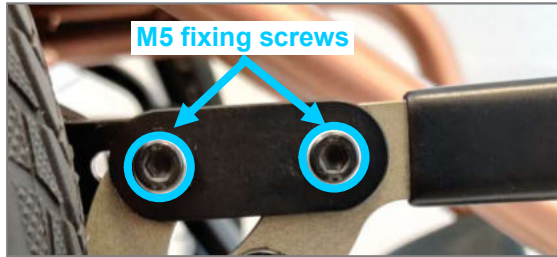

Figure 122: M5 fixing screws on the brake holding rail (installed at the front); LIFT activ



Figure 123: Knee lever brake (low assembly position), long brake lever; LIFT solid



Figure 124: Knee lever brake (installed at the rear on the LIFT solid; view from the rear)



Figure 125: Distance between the brake pin and tyre of approx. 3 to max. 4 mm with the brake opened (installed at the front)

3. Position the opened brake on the brake holding rail so that there is a distance of between approx. 3 to max. 4 mm between the brake pin and the tyre.

4. Tighten the M5 fixing screws (AF 4 mm) again to 4 Nm.
5. Then check the correct setting of the brakes: On a slope (7° gradient) the product should stand firm with the brake applied. This is the case if, with the brake applied, the tyre is depressed or deformed by approximately 4 mm by the brake pin (at the specified tyre inflation pressure). When the brake is open, the distance between the brake pin and the tyre is approx. 3 to maximum 4 mm.
6. The **actuating force** of the brake lever can be adjusted using the M5 joint screws and M5 nuts. For this purpose, you need a slotted screwdriver and an open-ended spanner (AF 8 mm). The screw is held at the front with the slotted screwdriver and the open-ended spanner (AF 8 mm) is used to tighten or loosen the nut at the rear. An important point here is that both joint screws must be tightened equally as this leads to a long-lasting uniform actuating force of the brake lever.



Figure 126: M5 joint screws for setting the actuating force of the brake lever (installed at the front)

Note:

The brake pin is usually mounted in the standard position (see following figure). The assembly of the brake pin in the other possible position (see following figure) may be necessary after the adjustment of the drive wheels.

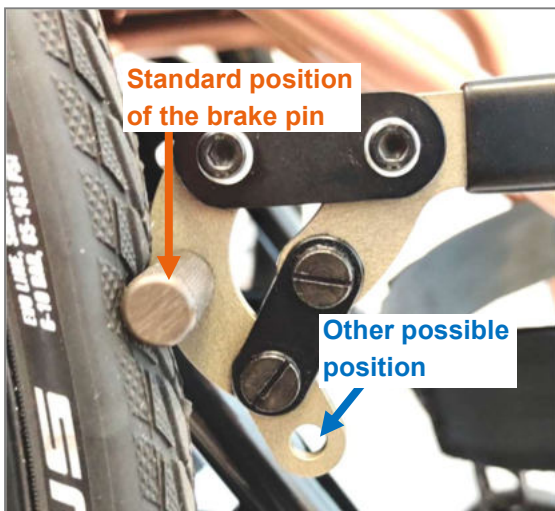



Figure 127: Positions of the brake pin (installed at the front)

26.1.3 Setting the brake on the LIFT solid installed on the armrest

 The following instructions are intended for and may only be carried out by a rehabilitation specialist dealer or PROACTIV

Settings on the brake could be necessary for the following reasons:

- You have changed the tyre or the tyre pressure.
- You have changed the wheel tracking or the position of the drive wheels.
- The brake is pulling unevenly or insufficiently after extended use.



Figure 128: Knee lever brake installed at the rear (view from the side)

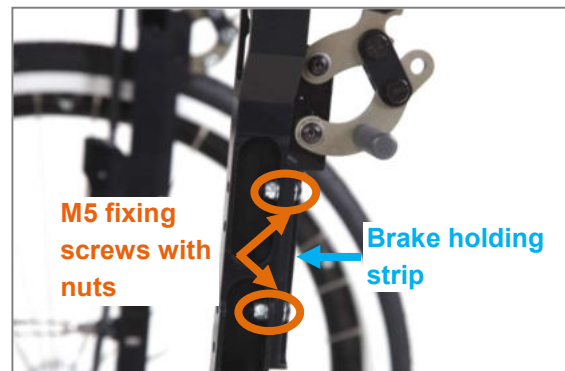

Figure 129: Knee lever brake installed at the rear (view from the side)

To adjust the knee lever brake, proceed as follows on both sides:

1. Initial situation: Drive wheels mounted on the product and the knee lever brakes open. The drive wheels have the specified inflation pressure.
2. For the **correct positioning** of the knee lever brake, slightly loosen the M5 fixing screws (AF 4 mm) that are used to fix the brake holding rail on the armrest.

3. Position the opened brake on the brake holding rail so that there is a distance of between approx. 3 to max. 4 mm between the brake pin and the tyre.
4. Tighten the M5 fixing screws (AF 4 mm) again to 4 Nm.
5. Then check the correct setting of the brakes: On a slope (7° gradient) the product should stand firm with the brake applied. This is the case if, with the brake applied, the tyre is depressed or deformed by approximately 4 mm by the brake pin (at the specified tyre inflation pressure). When the brake is open, the distance between the brake pin and the tyre is approx. 3 to maximum 4 mm.
6. The **actuating force** of the brake lever can be adjusted using the M5 joint screws and M5 nuts. For this purpose, you need a slotted screwdriver and an open-ended spanner (AF 8 mm). The screw is held at the front with the slotted screwdriver and the open-ended spanner (AF 8 mm) is used to tighten or loosen the nut at the rear. An important point here is that both joint screws must be tightened equally as this leads to a long-lasting uniform actuating force of the brake lever.



Figure 130: Overview of terms

Note:

The brake pin is usually mounted in the standard position (Fig. 127). Assembly of the brake pin in the other possible position (Fig. 127) may be necessary after the adjustment of the drive wheels.

26.1.4 Setting the brake on the LIFT solid, double knee lever brake



The following instructions are intended for and may only be carried out by a rehabilitation specialist dealer or PROACTIV

With this system, one knee lever brake is installed at the rear (**electric LIFT solid**) or on the armrest (**mechanical LIFT solid**) and the other at a lower position. The description can be found in the respective chapter.

26.2 Integral parking brake on the LIFT activ

This equipment is only possible on the LIFT activ.

26.2.1 Opening and closing the brake

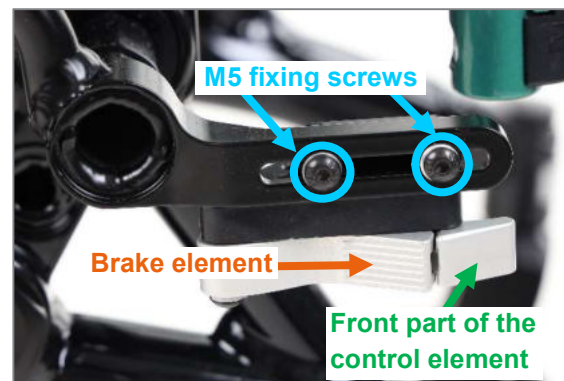

Figure 131: Overview of terms

Closing the brake is carried out by pressing the front part of the control element to the right or left outwards until the brake element rests against the tyre. Then press the control element (on the front part) towards the tyre until the control element rests against the brake element and the brake noticeably engages.



Figure 132: Integral brake open, closing is carried out by pressing the control element outwards

With the brake closed, the brake element is perpendicular to the brake mount and the brake element pushes approximately 4 mm into the tyre (with the specified air pressure in the tyres).

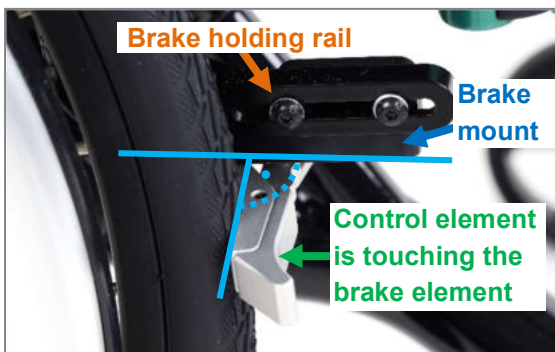

Figure 133: Integral brake closed, brake element vertical to the brake mount

⚠ Please note that the integral brake is a parking brake which may only be applied when the product is at a standstill. This is not a service brake which is suitable for reducing speed.

To **open the brake**, press the front part of the control element towards the middle of the wheelchair (away from the wheel).



Figure 134: Integral brake closed, the brake is opened by pressing the control element towards the middle of the wheelchair

⚠ When opening and closing the brakes, make sure that the control and brake element are never grasped. Press the brake only using one finger or with the ball of your hand on the front part of the control element.

26.2.2 Setting the integral brake

🔧 The following instructions are intended for and may only be carried out by a rehabilitation specialist dealer or PROACTIV

Settings on the brake could be necessary for the following reasons:

- You have changed the tyre or the tyre pressure.
- You have changed the wheel tracking or the position of the drive wheels.
- The brake is pulling unevenly or insufficiently after extended use.

To adjust the integrated brake, proceed as follows on both sides:

1. Initial situation: Drive wheels mounted on the product and the integral brakes open. The drive wheels have the specified inflation pressure.
2. Slightly loosen the M5 fixing screws (AF 4 mm) (Fig. 131) so that the brake mount

can be moved on the brake holding rail (Fig. 133).

3. Press the front part of the control element to the right or left outwards until the brake element rests against the tyre. Do not close the brake completely.



Figure 135: Brake element resting on the tyre

4. Move the integral brake on the brake holding rail so that the brake element is positioned as shown in the following figure:



Figure 136: Brake element after correct positioning of the integral brake

5. Tighten up the M5 fixing screws screw (AF 4 mm) again to 4 Nm.
6. Then check the correct setting of the brakes: On a slope (7° gradient) the product should stand firm with the brake applied. This will happen if, with the brake closed, the tyre is depressed or deformed by approximately 4 mm by the brake ele-

ment (at prescribed air pressure in the tyres).

27 Push handles

27.1 Back tube with integrated handles



Figure 137: Back tube with integrated handles

With these push handles, there is no option for adjustment and no possibility to remove the handle.

27.2 Aluminium push handles fixed in back tube



Figure 138: Aluminium push handles fixed in back tube

It is not possible to adjust these push handles.

To **remove** the push handles, undo the M6 fixing screw (AF 4 mm) with washer on both sides. The push handles can then be pulled out from the back tubes.

To **install** the push handles, place these in the back tube and insert the M6 fixing screws (AF 4 mm) (with washers) into the each of the holes of the back tube and push handle. Tighten the M6 fixing screws (AF 4 mm) to 11 Nm torque and secure them with thread-locking fluid.

27.3 Push handles, horizontally screwed in back tube



Figure 139: Push handles, horizontally screwed in back tube

It is not possible to adjust these push handles.

To **remove** the push handles, turn these counter-clockwise out of the back tube.



Figure 140: Screw the push handle horizontally out of the back tube

To **install** the push handle, turn it into the back tube clockwise and tighten it to a maximum hand tightness.

27.4 Safety push handles with continuous height adjustment

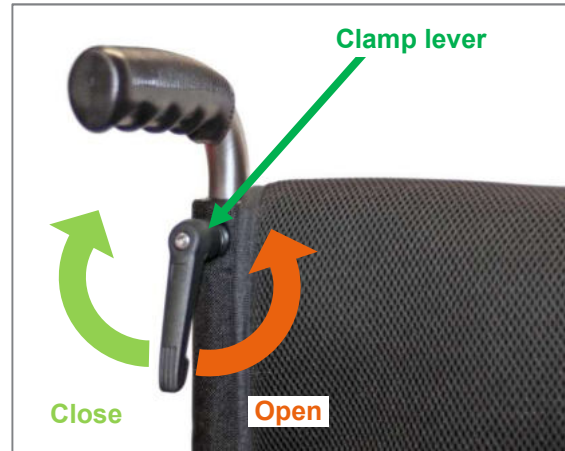

Figure 141: Safety push handles with infinite height adjustment

For **adjusting the height** of the push handles, open the clamp lever by turning counter-clockwise (a half to a complete rotation). Then the height of the push handles can be adjusted. The height can be infinitely adjusted. We recommend adjusting both push handles to the same height. Once the desired height is set, hold the push handles in this position and then close the clamp lever again clockwise with a half to complete rotation.

Note:

If the clamp lever knocks against the push handle when turning it, you can pull the clamp lever out perpendicular to the rotary axle, release it again in another angle position via the integrated serration and keep on turning. This also permits the position of the clamp lever to be aligned to the back tube after performing the height setting so that this does not protrude over the back tube to the side.



Video Safety push handles with continuous height adjustment



Figure 142: Put the clamp lever in another angled position by pulling out

To **remove** the push handles, turn the clamp lever out on each side (by turning anti-clockwise). Then the push handle can be removed from the back tube.

To **attach** the push handles, insert them into the back tubes. Then insert the clamp lever into the hole in the back tube and the push handle thread. Finally, tighten the clamp lever again (by turning clockwise).

27.5 Safety push handles back-positioned

Adjusting the height of back-positioned push handles is possible without tools using the quick release levers. For adjusting, the quick release levers are opened and closed again after adjusting. The height can be infinitely adjusted. We recommend adjusting both push handles to the same height.



Video Height adjustment of safety push handles offset to the back

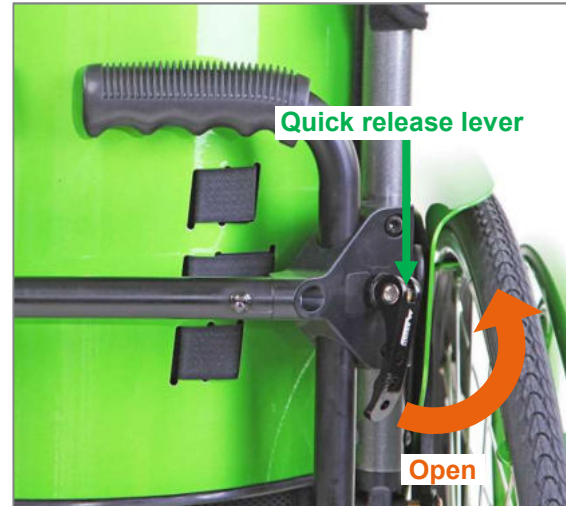

Figure 143: Closed quick release lever

To **remove** the push handle, the M4 end stop screw (AF 3 mm) needs to be unscrewed and the quick release lever needs to be opened.



Figure 144: M4 end stop screw mounted at the bottom of a push handle offset to the back

To **attach** them, the push handles are inserted and held at the correct height, and the quick release levers are closed. Finally, the M4 end stop screws (AF 3 mm) are screwed in again.

If necessary the tension can be adjusted by turning the quick release lever clockwise until it reaches the end stop.

Each time prior to use, the M4 end stop screws (AF 3 mm) must have been mounted again.

27.6 Safety instructions

 After every adjustment or after reattachment following removal, check that the push handles are firmly attached in position.

 Due to environmental effects, it is possible that the properties and therefore secure attachment of the push handle covers may change detrimentally. For this reason, it is important to check that the handles are tightly fitted and fixed in position prior to use. If this should no longer be the case, then the push handles may not be used until they have been fixed.

28 Lift system

The position of the trigger for the lift system can be selected. It is always fastened on one side on the LIFT activ and LIFT solid (left or right). The following images show the release handle/control knob installed on the right.

28.1 Lift system on the LIFT activ

28.1.1 Setting the pretension

 The following instructions are intended for and may only be carried out by a rehabilitation specialist dealer or PROACTIV

Setting the pretension serves to prevent the release handle from getting loose.

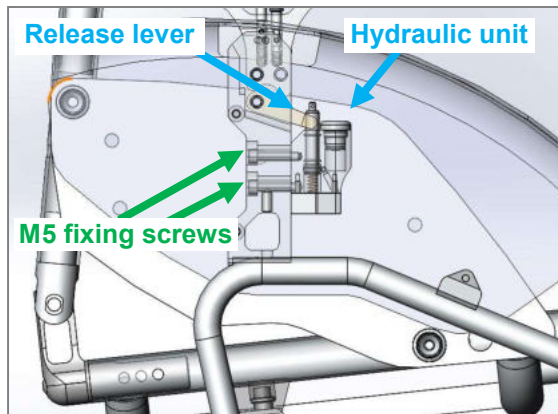

Figure 145: Release mechanism

Setting:

1. Loosen the M5 fixing screw (AF 4 mm; Fig. 145).
2. Reposition the hydraulic unit further up if the pretension is too low (the pretension is too low when the release handle is loose). If the pretension is too high, reposition the hydraulic unit further down (the pretension is too high when the release is continuously actuated).
3. Now tighten up the two M5 fixing screws to 4 Nm.
4. Check whether the release handle is loose or continuously actuated. Repeat the procedure if necessary until the release handle is properly pretensioned.

28.1.2 Unlocking & locking the lift function

The lift mechanism can be locked by the locking mechanism on the release handle. As a result, the release handle can also be used as a stand-up aid.



Figure 146: Release handle on the right (release handle is locked)

Locking:

Press the locking knob (Fig. 146). Press the locking knob down, until it reaches the stop. The unlocking knob is ejected by doing so. The red mark on the locking knob (Fig. 147) is then no longer visible.

Unlocking:

Press the unlocking knob (Fig. 146). Press the unlocking knob down, until it reaches the stop. The locking knob is ejected by doing so. The locking knob has a red mark (Fig. 147). If this mark is visible, the release handle is unlocked.



Video Locking the release handle

28.1.3 Adjusting the seat height

The seat height can be adjusted using the release handle.

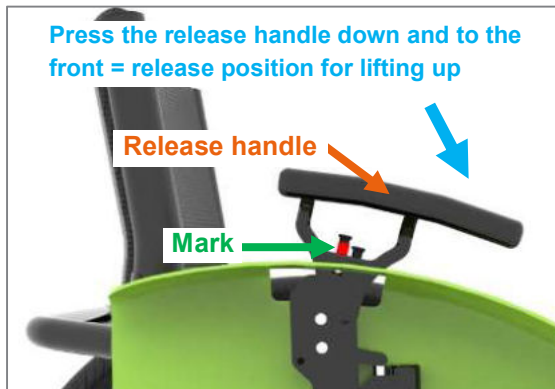

Figure 147: Release handle in lifting release position

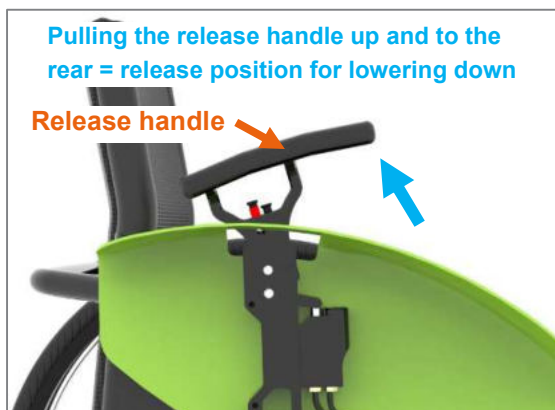

Figure 148: Release handle in lowering release position

1. Close the parking brake (Chapter 26).
2. Recommended holding of the release handle: Grasp the release handle with your fingers. Your thumb rests at the end of the release handle.
3. Press the release handle down and to the front (Fig. 147) to lift up or pull it up and to the rear (Fig. 148) to lower down again.



Please observe the safety instructions regarding the lift function in chapter 14 before using the lift mechanism.



Video Seat height adjustment on the LIFT activ

28.2 Mechanical lift system on the LIFT solid

The **standard version** of the mechanical LIFT solid uses the armrests with aluminium handle and release mechanism as a control element.

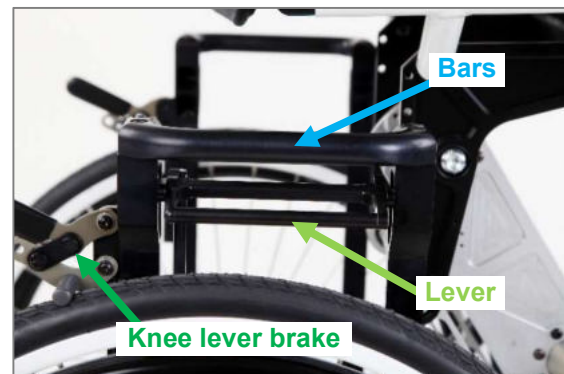

Figure 149: Mechanical release mechanism



Figure 150: Actuated mechanical release mechanism

Adjusting the seat height (standard version):

1. Close the parking brake.
2. Grasp the bars of the armrest in the middle with both hands. Make sure that your thumb is not spread apart.
3. Pull the lever for the release mechanism upwards (as a standard, this lever is installed on the right under the armrest).
4. Press the actuated lever up, to lift the seat position.
5. To adjust the seat position further down, pull the actuated lever down.
6. As soon as you let go of the release mechanism lever, the product is locked at the desired height.

Note:

As an option for strength assistance for finger function, the release mechanism is additionally equipped with a **pressure plate**.

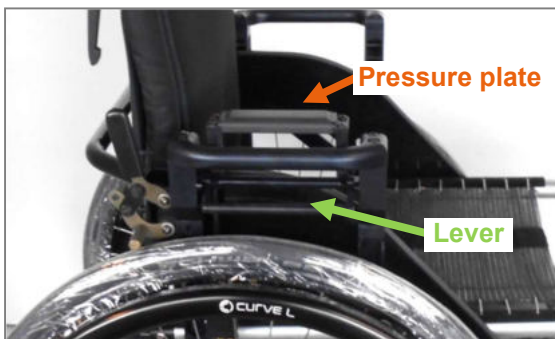

Figure 151: Release mechanism, additionally equipped with a pressure plate

For strength assistance, the lever (Fig. 151) and the pressure plate are actuated. In doing so, press the pressure plate down with the ball of your thumb. Actuation using only the pressure plate is also possible. In doing so, make sure that your fingers are not spread apart (risk of pinching).

The procedure for adjusting the seat height can be found in the previous section for the standard version.



Video Seat height adjustment on the LIFT solid mechanical

28.2.1 Folding the armrests up/down before/after transport

For a smaller pack size for transport, the armrests can be folded down.

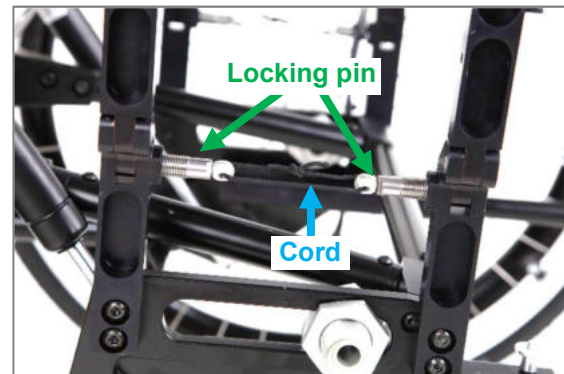

Figure 152: Armrest with folding mechanism

To **fold down** or **fold up**, take off the drive wheel (Chapter 22). Then pull the cord down and fold the armrests **up** or **down** on both sides.

28.3 Electric lift system on the LIFT solid

The electric LIFT solid uses an electric control element for adjusting the seat height. The control element is installed on one side of the product.



Figure 153: Control element

Adjusting the seat height:

1. Close the parking brakes (Chapter 26).
2. Press the control button (Fig. 153; red = lift, green = lower) to adjust the seat surface up or down.
3. As soon as you let go of the corresponding control knob, the product stops at the desired height.

Please observe the safety instructions regarding the lift function in chapter 14 before using the lift mechanism.

29 Rechargeable battery & charger for electric seat height adjustment on the LIFT solid

29.1 Technical specifications for the rechargeable battery

Type: Li ion
 Nominal voltage: 25.9 V
 Nominal capacity: 10.4 Ah
 Output: 269 Wh

29.2 Charging the rechargeable battery

The supplied charger must be used to charge the rechargeable battery (Fig. 154). The rechargeable battery can remain on the wheelchair during the charging procedure. Alternatively, the rechargeable battery can be removed for charging. With a full battery charge, approx. 200 lift cycles (complete up and down movements) are possible. Charging the rechargeable battery daily or every second day is recommended.

The charger heats up during the charging procedure. For this reason, it should not be used near heat sources and should be placed on a surface that is not sensitive to heat.



Figure 154: Charger

The charger plug must audibly engage in the battery socket (Fig. 155).

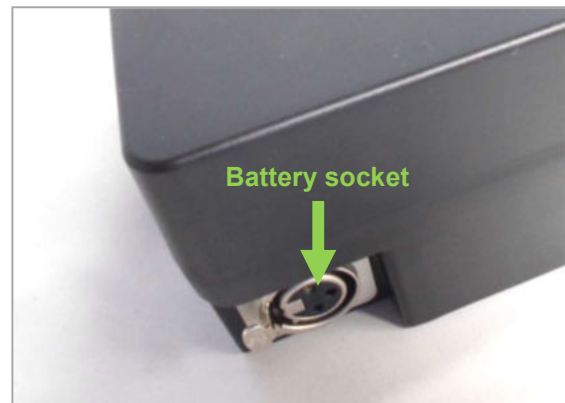

Figure 155: Battery socket

The charger has a light indicator that flashes green when the battery is charging and is steady green when it is fully charged (Fig. 156).



Figure 156: Light indicator on the charger

The maximum charging time for completely discharged batteries is approx. 7 hours. When the battery is fully charged, the charger automatically switches to trickle charging.

To remove the charger plug, you must press the unlocking slider on the rechargeable battery (Fig. 157).



Figure 157: Unlocking the charger plug

After the charging procedure, the charger must also be disconnected from the power supply (power socket).

Optionally, charging at the rear of the wheelchair on the charging socket on the control box is possible. To do so, remove the cover from the charging socket and set the switch to "Charge" (Fig. 158). Now you can insert the charger plug into the socket.



Figure 158: Preparation for charging at the rear of the wheelchair

After charging, the switch has to be set back to "Operation".

29.3 Removing the rechargeable battery

Disconnect the plug connection (Fig. 159). To do so, you must press the unlocking slider on the rechargeable battery (Fig. 157). Open the Velcro band (Fig. 160 and 161). Now the rechargeable battery can be lifted out to the front.



Figure 159: Disconnected plug connection





Figure 160: Open the Velcro band, Step 1





Figure 161: Open the Velcro band, Step 2

29.4 Safety instructions

 Improper handling of the rechargeable battery can cause electrolyte fluid to leak. This can cause skin injuries or damage to clothing. If skin or eyes come into contact with the electrolyte fluid, they must be rinsed with pure water and a doctor consulted immediately.

 The rechargeable battery may not be exposed to heat or fire or be burned. External heat effects can cause the rechargeable battery to explode. The rechargeable battery must not be submerged in water or be splashed with water. Always ensure that the rechargeable battery remains dry and clean.

 The rechargeable battery may not be opened or taken apart. Improper opening or deliberate destruction of the rechargeable battery bears the risk of severe injury. All warranty claims expire when the rechargeable battery is opened.

 Rechargeable batteries that have suffered mechanical damage may no longer be used.

 The contacts of the rechargeable battery must not be short-circuited. A short-circuit causes very high currents which could damage the battery and/or the product.

 The rechargeable battery of the product may only be charged using the original charger from the manufacturer which was supplied. It can be charged in any position.

 The charger may only be used under dry conditions. Protect it from rain and humidity, fire and high temperatures. Avoid temperature fluctuations that can cause condensation.

 During the charging process, the charger may not be covered with any objects.

 During the charging procedure, the charger must be placed on a surface that is not sensitive to heat and may not be placed on body parts.

 The charger may only be cleaned with a dry cloth.

30 Storage

When being stored, the product should be kept in a dry environment and covered up where possible.

To avoid corrosion and therefore malfunctions or breakages of components, the product may not be exposed to any aggressive environmental influences (especially salt) or to any strong solar radiation. Because of the effect of salt water in the winter and the humidity on rainy days, it is not recommended to store the product in the garage.

 The product may only be stored at ambient temperatures between -25°C and 50°C.

Information for the LIFT solid electric:

It is recommended to disconnect the rechargeable battery from the wheelchair during longer periods of non-use.

 If the product is not used or is stored over a longer period, if necessary, before using it again, we recommend having a rehabilitation specialist dealer give it a general function and safety check.

 When the rechargeable battery is stored or taken out of use, it should only be stored with a charge status of between 50% and 70%; it must be charged to 70% at the latest every two months. Before re-use, the rechargeable batteries must be completely charged.

 Store the rechargeable battery in a dry location where it is protected against damage and unauthorized access. The rechargeable battery should never be exposed to extreme temperature fluctuations and it should always be protected from moisture during storage to prevent corrosion of the plug contacts. If the product is stored in a cool location or in a location with temperature fluctuations, it is recommended that the rechargeable battery be re-

moved and stored separately at an appropriately tempered location.

 For optimum battery life, the rechargeable battery should be stored at a temperature of 18°C to 23°C and a humidity of 0 to 80 per cent.

31 Transport

31.1 Securing handling of the product

When loading or transporting, the product can be held on the frame and on the back cross bar.

 Do not hold the product by the release handle of the lift mechanism.

31.2 Passenger transport in motor vehicles



Transporting people, be it the wheelchair user or other persons, in vehicles has not been tested by PROACTIV and is therefore not approved. All vehicle occupants must only sit on the seats installed in the vehicle during the journey with the associated restraint systems. Failing to observe this leads to increased risk of injury for the user as well as for third-parties.

 The product can be fitted with a headrest. These headrest systems are not suitable for use as headrests when being transported in a motor vehicle.

 The lap belt which may be fitted is not designed as a safety belt in a motor vehicle and may not be used for this purpose

31.3 Securing the product in a vehicle (without a person)

To reduce weight, individual components such as the caster forks with caster wheels and the drive wheels can be removed from the product for loading and stored separately. The product and all associated components must be secured during transport so that they are not

damaged (e.g., by falling over) and do not become a hazard to persons or other products. Before transport, check with your vehicle dealer about safely securing it using the existing fitted lashing rings or other securing devices. Suitable brackets are mostly available in the vehicle and are described in the operating manual of the vehicle.

When the product is in the transport vehicle, you or the person accompanying you should proceed as follows:

1. Operate the parking brake.
2. Secure and safely stow any components from the product which have been previously removed.
3. Block the lift mechanism with the safety belt (Chapter 4). On the LIFT activ, you must also lock the release handle (Chapter 28.1).
4. Bags, walking sticks, and other objects not belonging to the product which are on or in the product, must be removed and securely stowed.
5. Secure the product with lashing straps. To do this, use the existing securing devices in the vehicle. After securing, the product may not roll, slip or tip over to the side any more.

 The tensioning straps used to fasten the product securely in the transport vehicle must only be attached to the motor vehicle components intended for that purpose and to the frame of the product.

 Do not transport the product on the front passenger seat. The product could slip and impede the driver.

 Make sure that the release mechanism for the lift function is not actuated when transporting the product.

31.4 Passenger transport over obstacles in the product

 If the product with its user needs to be transported over an obstacle and there are suitable facilities such as a ramp or a lift available, then these should be used. If such facilities are not available, then the obstacle is to be overcome by being carried by two helpers. When carrying the product, it may not be lifted by the side sections, the drive wheels or the footrests. PRO ACTIV recommends holding the product by the frame and the back cross bar to carry it.

The procedure with stairs is usually as follows:

Climbing up stairs:

1. Lock the lift function on the LIFT activ (see Chapter 28.1).
2. Two assistants carry the product with its user backwards up the stairs. The anti-tipping supports are in the passive position.
3. The assistant behind the product has the control. They tilt the product and have a firm grip on the back cross bar during the transport process.
4. The second helper at the front grips the product by the frame and lifts the product up one step at a time.
5. The helpers then move to the next step up and repeat the process until they reach the end.
6. The user can help the climb by rotating the handrim.

Climbing down stairs:

1. Lock the lift function on the LIFT activ (see Chapter 28.1).
2. Two assistants carry the product with its user forwards down the stairs. The anti-tipping supports are in the passive position.
3. The assistant behind the product has the control. They tilt the product and have a firm grip on the back cross bar during the transport process.

4. The second assistant stands securely on a lower step and grips the product by the frame. They lift the product down one step by letting the drive wheels roll over the edge of the step.
5. The helpers then stand on the next step down and repeat the process until they reach the end.
6. The user can help the descent by breaking on the handrim.

31.5 Transport in aircrafts (LIFT solid electric)

The lithium rechargeable batteries used are classified as hazardous goods for transport by air. Claiming the right to air transport is not permitted. The decision about the transport is the sole responsibility of the airline and this should be discussed in advance of the flight or the booking.

32 Malfunctions

In the event of any malfunctions which cannot be repaired by yourself based on the usage instructions included in the scope of delivery, please contact your rehabilitation specialist dealer or PRO ACTIV directly.

 Malfunctions must be repaired before any further use or, if they occur during the trip, it must be interrupted immediately.

All serious incidents that have occurred in connection with the product must be reported to the manufacturer and the responsible authority in the state in which the user resides.

33 Cleaning and care

Regularly cleaning the product is prescribed to prevent the components from becoming stiff due to soiling. In particular, the product should be carefully cleaned after every major use, e.g. summer or winter holidays.

To avoid corrosion and therefore malfunctions or breakages of components, the product may

not be exposed to any aggressive environmental influences. If this cannot be avoided, the product must always be cleaned immediately after such use, and moving parts must be greased. Regular cleaning prevents corrosion and increased wear.

In case the product becomes wet when using, dry it after use.

 Clean the quick release axles of the drive and caster wheels as well as the ball bearings and grease these with a little lubricating oil with high corrosion protection properties (e.g. Ne-oval MTO 300) approx. every 8 weeks in order to guarantee the reliable functioning properties.

 Clean your product with water, solvent or neutral cleaning agents. Do not use any abrasive cleaning agents or aggressive, acidic cleaners, to prevent scratching or fading of the coating or the anodised parts. Only use water and soap to clean the seat and backrest upholstery.

 The product must not be cleaned using steam or high pressure.

Recommended care:

If you need care products for your product, please contact PRO ACTIV.

34 Maintenance

34.1 General instructions

The product is not a maintenance-free device. Therefore, please observe the following instructions about maintenance.

 If repairs are required or there are any defects on your product, you should contact your rehabilitation specialist dealer or PRO ACTIV before using it again and have the defect remedied in the interests of your own safety. Screws and other elements need to be secured properly again after repairs.

 For tyres with tread: As soon as there is one or more points with less than 1 mm of

tread on the tyres, the tyres must be changed as otherwise there is an increased risk of an accident.

 For tyres without thread: As soon as there is one or more points where the tyre carcass or the puncture-proofing is visible, the tyres must be changed as otherwise there is an increased risk of an accident.

 Only manufacturer's original parts may be used when ordering spare parts.

 Repairs and conversions to the product may only be carried out by your rehabilitation specialist dealer or PRO ACTIV.

Tightening torques and securing details for fastening elements as shown in the table in chapter 39 must be observed.

34.2 Service schedules

There is some **maintenance work or checks which should be carried out by the user themselves** at regular intervals (approximately every 4 weeks depending on the frequency of use):

- Check the tyres for damage, foreign bodies and any cracks that form.
- Check the tyre pressure and correct if needed (the tyre pressure should always be as printed on the tyre covers).
- Check the brakes (function, wear on brake pins).
- Clean and oil the pivot points of the brakes and check the ease of movement or actuation force of the brake levers.
- Check the function of the anti-tipping device.
- Check the stable stand of the seat and backrest upholstery.
- Check the tight fit of the fixing screws on the seat and back system.
- Check the function and ease of running of the quick release axles of the drive wheels and caster forks.

 If you should discover any problems during these checks, please immediately contact your rehabilitation specialist dealer or PRO ACTIV. Service and repair work on the product may only be carried out by your rehabilitation specialist dealer or PRO ACTIV.

In addition to these maintenance tasks/checks by the user, PRO ACTIV has prescribed **maintenance tasks to be carried out by the rehabilitation specialist dealer or PRO ACTIV** for safe operation of the product and to minimise the risk to the user or third-parties.

The initial inspection is performed six weeks after delivery. The maintenance schedule can be found in the inspection lists in chapter 42.

Subsequent inspections are then always performed a year after the last inspection. The maintenance schedule can be found in the inspection lists in chapter 42.

After extreme stresses, such as during holidays where the product was exposed to sand, sea water or snow, an additional deep clean and inspection by your rehabilitation specialist dealer is recommended.

To maintain the warranty validity, the performance of the maintenance tasks must be documented. Any faults identified during maintenance work must be rectified and documented as such before further use of the product.

Even if your product does not show any signs of wear, damage or malfunctions, the regular safety-related checks on your product must be carried out in accordance with the maintenance schedule.

34.3 Proof of maintenance

To provide proof of the maintenance, you can use the inspection lists in chapter 42. Always keep all receipts/service reports as proof, and have any service work that has not been carried out by the manufacturer documented.

Please bring these usage instructions/the service booklet along with you each time maintenance is performed.

35 Disposal & recycling

At the end of the service life, the product can be returned to PRO ACTIV or your rehabilitation specialist dealer for disposal in a proper, environmentally-friendly manner.

The disposal or recycling must be carried out by a waste disposal company or a municipal waste disposal centre.

Special guidelines may apply on-location with regard to the disposal or recycling. These must be clarified and considered when disposing (this may also include the cleaning or disinfection of the product before the disposal).

In the following text, you will find a description of the materials for the disposal and recycling of the product and its packaging:

Aluminium: Frame, rims, caster forks, brakes, back cross bar, side sections, clothes guard, anti-tipping protection, armrest frame, footrest, footplate, push handles

Steel: Fixing points, quick-release/screwed axle, anti-tipping supports, brakes, screws, nuts

Plastic: Handles, quick release levers, tube plugs, caster wheels, armrest padding, tyres, footplate support, side sections, brake lever, anti-tipping wheels, bags for packing

Synthetic fibres and foam: padding, covers

Cardboard/paper: Packaging

 **Gas pressure springs:** Dampers, gas pressure and gas tension springs are under pressure. They may not be opened or heated.

Moreover, the gas pressure springs contain an oil filling. It must be disposed of in compliance with the Waste Management Act.

Hydraulic unit: The hydraulic unit contains an oil filling. The oil must be disposed of in compliance with the Waste Management Act.

LIFT solid electric:



According to the WEEE Directive, electric and electronic devices must be disposed of in government-designated recycling facilities separate from general residual waste. Proper disposal serves

to prevent possible environmental and health damage.

These guidelines are applicable only to devices that are installed or operated in the EU. Regulations may differ outside of the European Union.

36 Re-use

If your product has been provided to you by your funding provider and you no longer require it, you should report this fact to your health insurance company or your rehabilitation specialist dealer. Your product can then be simply and economically re-used.

Prior to each re-use, a technical safety check must be carried out on the product at PRO ACTIV or the rehabilitation specialist dealer. In addition to the instructions contained in chapter 33 (Cleaning and care), a thorough cleaning of all control elements must be carried out before using it again.

Before the product can be reused, it must be prepared with care. A disinfection agent that is suitable for medical products must be sprayed onto all surfaces that the user may come into contact with. A liquid, alcohol-based disinfectant for residue-free, quick disinfection (e.g. Exporit 4712) must be used for this, and the respective usage instructions for use of the disinfectant must be observed. In general, a complete disinfection cannot be guaranteed on the seams. We therefore recommend that you dispose of the seat and backrest upholstery.

These preparations will be performed by PRO ACTIV or the rehabilitation specialist dealer as part of the technical safety check. This safety-related check **must** be initiated by the funding provider.

Moreover, in event of wear or due to adaptation to the new user, components such as the footrest, seat and back system can be adjusted or replaced using the modular system. In addition, the backrest angle is usually adjustable in seven stages, therefore enabling optimum adaptation.

37 Warranty

PRO ACTIV guarantees that the product was free of any defects at the time it was handed over. This warranty expires 24 months after the product was delivered.

Further information can be found in PRO ACTIV's general terms and conditions at www.proactiv-gmbh.com.

The warranty shall be null and void if the product or a part needs to be repaired or replaced due to the following reasons:

- Normal wear on components such as tyres of caster wheels & drive wheels, anti-tipping wheels, handles, brake pins, upholstery of seat and back systems, etc.
- The product has not been maintained and serviced in accordance with the maintenance schedule laid down by PRO ACTIV.
- The product or a part of the product has been damaged due to neglect, accident, or improper use.
- The product has been commissioned and used in non-compliance with these usage instructions.
- Repairs or other work have been carried out by non-authorised persons.
- Third-party parts have been installed or connected to the product or the product was otherwise modified.



Product modifications that have not been expressly approved by PRO ACTIV will invalidate the warranty. Such modifications can lead to unforeseeable safety risks and are therefore not permitted.

38 Liability

As the manufacturer of the product, PRO ACTIV is not responsible for its safety if:

- The product is handled improperly.
- The product is not maintained in accordance with the maintenance schedule laid down by PRO ACTIV.
- The product is commissioned and used in non-compliance with these usage instructions.
- Repairs or other work are carried out by non-authorised persons.
- Third-party parts have been installed or connected to the product or the product has otherwise been modified.

Further information can be found in PRO ACTIV's general terms and conditions at www.proactiv-gmbh.com.

39 Appendix: Tightening torques, securing details and tools

The following table shows the torques for shaft screws with a metric control thread (valid providing the drawing, assembly, or usage instructions do not state different values!):

Dimension	Tightening torque Ma in Nm depending on the screw strength	
	Strength 8.8 (e.g. cylinder head screw)	Strength 10.9 (e.g. oval head screw)
M4	2.1	3.1
M5	4.2	6.1
M6	7.3	11
M8	17	26
M10	34	51
M12	59	87
M10 x 1	36	53

Securing details: All screws on PRO ACTIV products must be secured with "medium strength" thread-locking fluid (e.g. Weicon AN302-43), provided that no securing clamps are present on the screw connections or a lubrication instruction specifies the use of grease or copper paste.

In the following table you will find tools and care products for your PRO ACTIV product:

Tool	Order number
Adjustment bracket for the caster wheel bearing block	E8000 901 000
Special tool for setting the wheel position Open-ended spanner AF 22/24 mm + 41 mm	E8000 900 025
Tool set for PRO ACTIV wheelchairs Mini high-pressure pump, open-ended spanner AF 8/10 + 10/13 30 mm, Allen key AF 2.5 + 6 mm, hexagon socket screwdriver with handle AF 3 + 4 + 5 mm	E8000 900 030
Care kit for PRO ACTIV wheelchairs and handbikes Assembly paste (dosing syringe 10 g), lubricating oil (spray 100 ml), thread lock, medium strength (pen system 10 ml), surface cleaner (spray 150 ml), terminal grease (tube 50 ml)	E8000 900 026
Assembly stands 	E8000 902 000

40 Appendix: Medical product passport/record of training

Product specifications:

Serial number: _____

Customer data:

Surname, forename: _____

Street: _____

Postcode, city: _____

Phone: _____

Paying organisation: _____

Training carried out by:

Rehabilitation specialist dealer

PRO ACTIV Field Representative/
Product adviser

<p>_____</p> <p>Stamp / Date / Rehabilitation specialist dealer's signature</p>

Record of training

I was/we were instructed in accordance with the associated hand-over certificate about the operation of the product listed and informed about possible operator errors. I was/we were also advised about situations where the assistance of another person is required. The usage instructions were handed to me/us.

Instructor

Name, date, signature _____

1. Person being trained

Name, date, signature _____

2. Person being trained

Name, date, signature _____

3. Person being trained

Name, date, signature _____

For minors, or persons who are not responsible for their actions, legal guardians/supervisors/responsible persons are to be trained in the use. This is confirmed by their signature. The data are recorded in the feedback system of PRO ACTIV Reha-Technik GmbH as the manufacturer of the above named product. It is managed in accordance with § 16 BDSG (German Data Protection Law).

41 Appendix: Hand-over certificate

41.1 Required compliance criteria to authorise use

Topics	Completed/ fulfilled	Remarks
The product is suitable for the customer based on their own judgement and the customer information received regarding the disability-related restrictions.		
The use intended by the customer is fully consistent with the intended use as described in the usage instructions (see Chapter "Purpose and indication").		
The product's equipment is suitable to allow the customer safe use with maximum reduction of risks.		
The customer's driving ability was checked during a test drive in difficult driving situations and found to be appropriate (see the check list on the following page).		
The usage instructions - and explicitly all of the warning and safety instructions contained therein - were discussed during the training in detail and understood by the user. The user was then handed these operating instructions.		

41.2 Check list for training the user

Topics	Completed/ fulfilled
All mechanical function control elements were explained and their function demonstrated.	
Use of the brakes was demonstrated and then performed by the user themselves and/or their assistant.	
Attention was drawn to the fact that it is a parking brake and not a service brake.	
Backrest angle adjustment and other backrest adjustment options were demonstrated and then tested by the user themselves and/or their assistant.	
The possible adjustments of the seating system were demonstrated and then tested by the user themselves and/or their assistant.	
Fitting and removing the clothing guard was demonstrated and then tested by the user themselves and/or their assistant.	
How the push handles are used and adjusted was demonstrated and then tested by the user themselves and/or their assistant.	
How the footrests work was demonstrated and then tested by the user themselves and/or their assistant.	
Use of the anti-tipping supports was demonstrated and then performed by the user themselves and/or their assistant.	
Removal and installation of the drive wheels and the caster forks (with quick-release axles) was demonstrated and then tested by the user themselves and/or their assistant.	
The lift function was explained, its function was demonstrated and then tested by the user themselves and/or an assistant.	
The recommend holding of the release handle was demonstrated and then tested by the user themselves and/or an assistant.	
Test drive: Overcoming obstacles with the product, e.g. a kerb	
Test drive: Driving forwards and backwards on level ground and also up and down hills in the direction of travel, including slaloming around some obstacles	
Test: Operating the anti-tipping supports in front of an obstacle	
Information for care, cleaning and maintenance of the product (including quick release axles) have been provided and understood by the user and/or assistant.	
Information on the wheels with regard to inflation pressure and tread depth and checking the quick release axles have been provided and understood by the user and/or assistant.	
Information on regular checks of the brakes, anti-tipping supports and the seating and back system have been provided and understood by the user and/or assistant.	
The content of the usage instructions from PRO ACTIV and the other component manufacturers (if available) were completely worked through based on the product training and were understood by the user and/or the assistant.	

The use of the product is only permitted when all topics listed in "Required compliance criteria for those permitted to use" have been met by the user and all the points have been ticked off in the "Check list for training the user".

42 Appendix: Inspection lists

Initial inspection: after 6 weeks

Serial number: SN _____	OK/ carried out	not OK	resolved
Check that all screws/fastening elements are firmly seated	<input type="checkbox"/>	<input type="checkbox"/>	<input type="checkbox"/>
Check that the wheel tracking and drive wheel bushing are firmly seated (tightening torque 70 Nm)	<input type="checkbox"/>	<input type="checkbox"/>	<input type="checkbox"/>
Check the correct adjustment of the caster fork rotary axle	<input type="checkbox"/>	<input type="checkbox"/>	<input type="checkbox"/>
Function and safety check of the brakes, push handles and anti-tipping supports as well as further functional components (such as, e.g. folding backrest, fold-up footrest)	<input type="checkbox"/>	<input type="checkbox"/>	<input type="checkbox"/>

OK / carried out = OK | not OK = not OK | resolved = the fault was corrected

Comments:

Rehabilitation specialist dealer:

First name and last name of contact:

Stamp:

Date/signature

To maintain the warranty rights, the completed inspection list must be sent by e-mail or post to PRO ACTIV within four weeks of the inspection.

Subsequent inspection: One year later after the last inspection or earlier following heavy use

Serial number: SN _____	OK / carried out	not OK	resolved
Check that all screws/fastening elements are firmly seated	<input type="checkbox"/>	<input type="checkbox"/>	<input type="checkbox"/>
Clean and oil/grease all pivot points, quick release axles and bearings	<input type="checkbox"/>	<input type="checkbox"/>	<input type="checkbox"/>
Carry out a visual inspection of the frame and attachments for crack formations, deformations, etc.	<input type="checkbox"/>	<input type="checkbox"/>	<input type="checkbox"/>
Functional/safety check of push handles	<input type="checkbox"/>	<input type="checkbox"/>	<input type="checkbox"/>
Functional/safety check of braking system	<input type="checkbox"/>	<input type="checkbox"/>	<input type="checkbox"/>
Functional/safety check of anti-tipping supports	<input type="checkbox"/>	<input type="checkbox"/>	<input type="checkbox"/>
Functional/safety check of the seat and back system	<input type="checkbox"/>	<input type="checkbox"/>	<input type="checkbox"/>
Carry out a functional/safety check of the drive wheels and, if required, replace the tyres on the product	<input type="checkbox"/>	<input type="checkbox"/>	<input type="checkbox"/>
Functional/safety check of the lift function	<input type="checkbox"/>	<input type="checkbox"/>	<input type="checkbox"/>
Check that the wheel tracking and drive wheel bushing are firmly seated (tightening torque 70 Nm)	<input type="checkbox"/>	<input type="checkbox"/>	<input type="checkbox"/>
Functional/safety check of caster wheels	<input type="checkbox"/>	<input type="checkbox"/>	<input type="checkbox"/>
Check the caster wheel axle for firm seating (tightening torque 7 Nm) and correct adjustment of the caster fork axle	<input type="checkbox"/>	<input type="checkbox"/>	<input type="checkbox"/>
Functional/safety check of footrests	<input type="checkbox"/>	<input type="checkbox"/>	<input type="checkbox"/>
LIFT solid electric: Check the electrical connections and the performance of the rechargeable battery	<input type="checkbox"/>	<input type="checkbox"/>	<input type="checkbox"/>
Test drive/functional test	<input type="checkbox"/>	<input type="checkbox"/>	<input type="checkbox"/>

OK / carried out = OK | not OK = not OK | resolved = the fault was corrected

Comments:

Rehabilitation specialist dealer:

First name and last name of contact:

Stamp:

Date/signature

To maintain the warranty, the completed inspection list must be sent by e-mail or post to PRO ACTIV within four weeks of the inspection.

Subsequent inspection: One year later after the last inspection or earlier following heavy use

Serial number: SN _____	OK / carried out	not OK	resolved
Check that all screws/fastening elements are firmly seated	<input type="checkbox"/>	<input type="checkbox"/>	<input type="checkbox"/>
Clean and oil/grease all pivot points, quick release axles and bearings	<input type="checkbox"/>	<input type="checkbox"/>	<input type="checkbox"/>
Carry out a visual inspection of the frame and attachments for crack formations, deformations, etc.	<input type="checkbox"/>	<input type="checkbox"/>	<input type="checkbox"/>
Functional/safety check of push handles	<input type="checkbox"/>	<input type="checkbox"/>	<input type="checkbox"/>
Functional/safety check of braking system	<input type="checkbox"/>	<input type="checkbox"/>	<input type="checkbox"/>
Functional/safety check of anti-tipping supports	<input type="checkbox"/>	<input type="checkbox"/>	<input type="checkbox"/>
Functional/safety check of the seat and back system	<input type="checkbox"/>	<input type="checkbox"/>	<input type="checkbox"/>
Carry out a functional/safety check of the drive wheels and, if required, replace the tyres on the product	<input type="checkbox"/>	<input type="checkbox"/>	<input type="checkbox"/>
Functional/safety check of the lift function	<input type="checkbox"/>	<input type="checkbox"/>	<input type="checkbox"/>
Check that the wheel tracking and drive wheel bushing are firmly seated (tightening torque 70 Nm)	<input type="checkbox"/>	<input type="checkbox"/>	<input type="checkbox"/>
Functional/safety check of caster wheels	<input type="checkbox"/>	<input type="checkbox"/>	<input type="checkbox"/>
Check the caster wheel axle for firm seating (tightening torque 7 Nm) and correct adjustment of the caster fork axle	<input type="checkbox"/>	<input type="checkbox"/>	<input type="checkbox"/>
Functional/safety check of footrests	<input type="checkbox"/>	<input type="checkbox"/>	<input type="checkbox"/>
LIFT solid electric: Check the electrical connections and the performance of the rechargeable battery	<input type="checkbox"/>	<input type="checkbox"/>	<input type="checkbox"/>
Test drive/functional test	<input type="checkbox"/>	<input type="checkbox"/>	<input type="checkbox"/>

OK / carried out = OK | not OK = not OK | resolved = the fault was corrected

Comments:

Rehabilitation specialist dealer:

First name and last name of contact:

Stamp:

Date/signature

To maintain the warranty, the completed inspection list must be sent by e-mail or post to PRO ACTIV within four weeks of the inspection.

Subsequent inspection: One year later after the last inspection or earlier following heavy use

Serial number: SN _____	OK / carried out	not OK	resolved
Check that all screws/fastening elements are firmly seated	<input type="checkbox"/>	<input type="checkbox"/>	<input type="checkbox"/>
Clean and oil/grease all pivot points, quick release axles and bearings	<input type="checkbox"/>	<input type="checkbox"/>	<input type="checkbox"/>
Carry out a visual inspection of the frame and attachments for crack formations, deformations, etc.	<input type="checkbox"/>	<input type="checkbox"/>	<input type="checkbox"/>
Functional/safety check of push handles	<input type="checkbox"/>	<input type="checkbox"/>	<input type="checkbox"/>
Functional/safety check of braking system	<input type="checkbox"/>	<input type="checkbox"/>	<input type="checkbox"/>
Functional/safety check of anti-tipping supports	<input type="checkbox"/>	<input type="checkbox"/>	<input type="checkbox"/>
Functional/safety check of the seat and back system	<input type="checkbox"/>	<input type="checkbox"/>	<input type="checkbox"/>
Carry out a functional/safety check of the drive wheels and, if required, replace the tyres on the product	<input type="checkbox"/>	<input type="checkbox"/>	<input type="checkbox"/>
Functional/safety check of the lift function	<input type="checkbox"/>	<input type="checkbox"/>	<input type="checkbox"/>
Check that the wheel tracking and drive wheel bushing are firmly seated (tightening torque 70 Nm)	<input type="checkbox"/>	<input type="checkbox"/>	<input type="checkbox"/>
Functional/safety check of caster wheels	<input type="checkbox"/>	<input type="checkbox"/>	<input type="checkbox"/>
Check the caster wheel axle for firm seating (tightening torque 7 Nm) and correct adjustment of the caster fork axle	<input type="checkbox"/>	<input type="checkbox"/>	<input type="checkbox"/>
Functional/safety check of footrests	<input type="checkbox"/>	<input type="checkbox"/>	<input type="checkbox"/>
LIFT solid electric: Check the electrical connections and the performance of the rechargeable battery	<input type="checkbox"/>	<input type="checkbox"/>	<input type="checkbox"/>
Test drive/functional test	<input type="checkbox"/>	<input type="checkbox"/>	<input type="checkbox"/>

OK / carried out = OK | not OK = not OK | resolved = the fault was corrected

Comments:

Rehabilitation specialist dealer:

First name and last name of contact:

Stamp:

Date/signature

To maintain the warranty, the completed inspection list must be sent by e-mail or post to PRO ACTIV within four weeks of the inspection.

Subsequent inspection: One year later after the last inspection or earlier following heavy use

Serial number: SN _____	OK / carried out	not OK	resolved
Check that all screws/fastening elements are firmly seated	<input type="checkbox"/>	<input type="checkbox"/>	<input type="checkbox"/>
Clean and oil/grease all pivot points, quick release axles and bearings	<input type="checkbox"/>	<input type="checkbox"/>	<input type="checkbox"/>
Carry out a visual inspection of the frame and attachments for crack formations, deformations, etc.	<input type="checkbox"/>	<input type="checkbox"/>	<input type="checkbox"/>
Functional/safety check of push handles	<input type="checkbox"/>	<input type="checkbox"/>	<input type="checkbox"/>
Functional/safety check of braking system	<input type="checkbox"/>	<input type="checkbox"/>	<input type="checkbox"/>
Functional/safety check of anti-tipping supports	<input type="checkbox"/>	<input type="checkbox"/>	<input type="checkbox"/>
Functional/safety check of the seat and back system	<input type="checkbox"/>	<input type="checkbox"/>	<input type="checkbox"/>
Carry out a functional/safety check of the drive wheels and, if required, replace the tyres on the product	<input type="checkbox"/>	<input type="checkbox"/>	<input type="checkbox"/>
Functional/safety check of the lift function	<input type="checkbox"/>	<input type="checkbox"/>	<input type="checkbox"/>
Check that the wheel tracking and drive wheel bushing are firmly seated (tightening torque 70 Nm)	<input type="checkbox"/>	<input type="checkbox"/>	<input type="checkbox"/>
Functional/safety check of caster wheels	<input type="checkbox"/>	<input type="checkbox"/>	<input type="checkbox"/>
Check the caster wheel axle for firm seating (tightening torque 7 Nm) and correct adjustment of the caster fork axle	<input type="checkbox"/>	<input type="checkbox"/>	<input type="checkbox"/>
Functional/safety check of footrests	<input type="checkbox"/>	<input type="checkbox"/>	<input type="checkbox"/>
LIFT solid electric: Check the electrical connections and the performance of the rechargeable battery	<input type="checkbox"/>	<input type="checkbox"/>	<input type="checkbox"/>
Test drive/functional test	<input type="checkbox"/>	<input type="checkbox"/>	<input type="checkbox"/>

OK / carried out = OK | not OK = not OK | resolved = the fault was corrected

Comments:

Rehabilitation specialist dealer:

First name and last name of contact:

Stamp:

Date/signature

To maintain the warranty, the completed inspection list must be sent by e-mail or post to PRO ACTIV within four weeks of the inspection.

Subsequent inspection: One year later after the last inspection or earlier following heavy use

Serial number: SN _____	OK / carried out	not OK	resolved
Check that all screws/fastening elements are firmly seated	<input type="checkbox"/>	<input type="checkbox"/>	<input type="checkbox"/>
Clean and oil/grease all pivot points, quick release axles and bearings	<input type="checkbox"/>	<input type="checkbox"/>	<input type="checkbox"/>
Carry out a visual inspection of the frame and attachments for crack formations, deformations, etc.	<input type="checkbox"/>	<input type="checkbox"/>	<input type="checkbox"/>
Functional/safety check of push handles	<input type="checkbox"/>	<input type="checkbox"/>	<input type="checkbox"/>
Functional/safety check of braking system	<input type="checkbox"/>	<input type="checkbox"/>	<input type="checkbox"/>
Functional/safety check of anti-tipping supports	<input type="checkbox"/>	<input type="checkbox"/>	<input type="checkbox"/>
Functional/safety check of the seat and back system	<input type="checkbox"/>	<input type="checkbox"/>	<input type="checkbox"/>
Carry out a functional/safety check of the drive wheels and, if required, replace the tyres on the product	<input type="checkbox"/>	<input type="checkbox"/>	<input type="checkbox"/>
Functional/safety check of the lift function	<input type="checkbox"/>	<input type="checkbox"/>	<input type="checkbox"/>
Check that the wheel tracking and drive wheel bushing are firmly seated (tightening torque 70 Nm)	<input type="checkbox"/>	<input type="checkbox"/>	<input type="checkbox"/>
Functional/safety check of caster wheels	<input type="checkbox"/>	<input type="checkbox"/>	<input type="checkbox"/>
Check the caster wheel axle for firm seating (tightening torque 7 Nm) and correct adjustment of the caster fork axle	<input type="checkbox"/>	<input type="checkbox"/>	<input type="checkbox"/>
Functional/safety check of footrests	<input type="checkbox"/>	<input type="checkbox"/>	<input type="checkbox"/>
LIFT solid electric: Check the electrical connections and the performance of the rechargeable battery	<input type="checkbox"/>	<input type="checkbox"/>	<input type="checkbox"/>
Test drive/functional test	<input type="checkbox"/>	<input type="checkbox"/>	<input type="checkbox"/>

OK / carried out = OK | not OK = not OK | resolved = the fault was corrected

Comments:

Rehabilitation specialist dealer:

First name and last name of contact:

Stamp:

Date/signature

To maintain the warranty, the completed inspection list must be sent by e-mail or post to PRO ACTIV within four weeks of the inspection.

Subsequent inspection: One year later after the last inspection or earlier following heavy use

Serial number: SN _____	OK / carried out	not OK	resolved
Check that all screws/fastening elements are firmly seated	<input type="checkbox"/>	<input type="checkbox"/>	<input type="checkbox"/>
Clean and oil/grease all pivot points, quick release axles and bearings	<input type="checkbox"/>	<input type="checkbox"/>	<input type="checkbox"/>
Carry out a visual inspection of the frame and attachments for crack formations, deformations, etc.	<input type="checkbox"/>	<input type="checkbox"/>	<input type="checkbox"/>
Functional/safety check of push handles	<input type="checkbox"/>	<input type="checkbox"/>	<input type="checkbox"/>
Functional/safety check of braking system	<input type="checkbox"/>	<input type="checkbox"/>	<input type="checkbox"/>
Functional/safety check of anti-tipping supports	<input type="checkbox"/>	<input type="checkbox"/>	<input type="checkbox"/>
Functional/safety check of the seat and back system	<input type="checkbox"/>	<input type="checkbox"/>	<input type="checkbox"/>
Carry out a functional/safety check of the drive wheels and, if required, replace the tyres on the product	<input type="checkbox"/>	<input type="checkbox"/>	<input type="checkbox"/>
Functional/safety check of the lift function	<input type="checkbox"/>	<input type="checkbox"/>	<input type="checkbox"/>
Check that the wheel tracking and drive wheel bushing are firmly seated (tightening torque 70 Nm)	<input type="checkbox"/>	<input type="checkbox"/>	<input type="checkbox"/>
Functional/safety check of caster wheels	<input type="checkbox"/>	<input type="checkbox"/>	<input type="checkbox"/>
Check the caster wheel axle for firm seating (tightening torque 7 Nm) and correct adjustment of the caster fork axle	<input type="checkbox"/>	<input type="checkbox"/>	<input type="checkbox"/>
Functional/safety check of footrests	<input type="checkbox"/>	<input type="checkbox"/>	<input type="checkbox"/>
LIFT solid electric: Check the electrical connections and the performance of the rechargeable battery	<input type="checkbox"/>	<input type="checkbox"/>	<input type="checkbox"/>
Test drive/functional test	<input type="checkbox"/>	<input type="checkbox"/>	<input type="checkbox"/>

OK / carried out = OK | not OK = not OK | resolved = the fault was corrected

Comments:

Rehabilitation specialist dealer:

First name and last name of contact:

Stamp:

Date/signature

To maintain the warranty, the completed inspection list must be sent by e-mail or post to PRO ACTIV within four weeks of the inspection.

Subsequent inspection: One year later after the last inspection or earlier following heavy use

Serial number: SN _____	OK / carried out	not OK	resolved
Check that all screws/fastening elements are firmly seated	<input type="checkbox"/>	<input type="checkbox"/>	<input type="checkbox"/>
Clean and oil/grease all pivot points, quick release axles and bearings	<input type="checkbox"/>	<input type="checkbox"/>	<input type="checkbox"/>
Carry out a visual inspection of the frame and attachments for crack formations, deformations, etc.	<input type="checkbox"/>	<input type="checkbox"/>	<input type="checkbox"/>
Functional/safety check of push handles	<input type="checkbox"/>	<input type="checkbox"/>	<input type="checkbox"/>
Functional/safety check of braking system	<input type="checkbox"/>	<input type="checkbox"/>	<input type="checkbox"/>
Functional/safety check of anti-tipping supports	<input type="checkbox"/>	<input type="checkbox"/>	<input type="checkbox"/>
Functional/safety check of the seat and back system	<input type="checkbox"/>	<input type="checkbox"/>	<input type="checkbox"/>
Carry out a functional/safety check of the drive wheels and, if required, replace the tyres on the product	<input type="checkbox"/>	<input type="checkbox"/>	<input type="checkbox"/>
Functional/safety check of the lift function	<input type="checkbox"/>	<input type="checkbox"/>	<input type="checkbox"/>
Check that the wheel tracking and drive wheel bushing are firmly seated (tightening torque 70 Nm)	<input type="checkbox"/>	<input type="checkbox"/>	<input type="checkbox"/>
Functional/safety check of caster wheels	<input type="checkbox"/>	<input type="checkbox"/>	<input type="checkbox"/>
Check the caster wheel axle for firm seating (tightening torque 7 Nm) and correct adjustment of the caster fork axle	<input type="checkbox"/>	<input type="checkbox"/>	<input type="checkbox"/>
Functional/safety check of footrests	<input type="checkbox"/>	<input type="checkbox"/>	<input type="checkbox"/>
LIFT solid electric: Check the electrical connections and the performance of the rechargeable battery	<input type="checkbox"/>	<input type="checkbox"/>	<input type="checkbox"/>
Test drive/functional test	<input type="checkbox"/>	<input type="checkbox"/>	<input type="checkbox"/>

OK / carried out = OK | not OK = not OK | resolved = the fault was corrected

Comments:

Rehabilitation specialist dealer:

First name and last name of contact:

Stamp:

Date/signature

To maintain the warranty rights, the completed inspection list must be sent by e-mail or post to PRO ACTIV within four weeks of the inspection.

Your rehabilitation specialist dealer:

PRO  **ACTIV**[®]



PRO ACTIV Reha-Technik GmbH

Im Hofstätt 11

72359 Dotternhausen – Germany

Phone +49 7427 9480-0

Fax +49 7427 9480-7025

Email: info@proactiv-gmbh.de

www.proactiv-gmbh.com