

Lattoflex 200



**„Lattoflex 200
is gold for the
back: the best
spring base in the
world!“**

**The backbone
for your bed**

Only genuine
with the gold seal!



Prof. Erich Schmitt MD
Chairman of the Board of Forum Gesunder
Rücken - besser leben e.V. (Forum Healthier
Backs – For A Better Life)

Product information

lattoflex®

Lattoflex 200 – the bed system for your enjoyment

Whether as a basic version or high-tech frame with comfort and convenience at the touch of a button, all models in the Lattoflex 200 series offer the unique wing spring system, the comfortable shoulder zone and the possibility of adjusting all the zones individually.

Together with a mattress by Lattoflex, which was specifically developed for these highly flexible spring bases, the Lattoflex bed system is turned into an oasis of peace and relaxation. Different mattress cores and a marvellous selection of covers will satisfy any customer's requests.

Please also note the great new possibilities to be found in this new brochure, such as remote control and the range of accessories (page 16).



- 1 Patented Lattoflex wing spring system
Extra-long spring arms adapt to the shape of the body in a unique fashion for fantastic comfort.
- 2 The unique fibreglass double section adjusts ideally to the body contour.
- 3 The side spring element cushions the main weight in each zone.



Reinforced zones for individual sleep requirements:
Additional supporting strips can be used to reinforce individual double sections, thus adapting Lattoflex 200 individually to specific customer needs.



For all motor frames: new Lattoflex radio remote control with colour display to control all motor settings and other options. Furthermore, the motor frames can also be controlled by Smart-phone as an option (see page 16).



The Lattoflex bed system has been inspected and is recommended by the Bundesverband der deutschen Rückenschulen e.V. and the Forum Gesunder Rücken – besser leben e.V.
For further information on the quality seal of AGR e.V., write to: P.O. Box 103
27443 Selsingen/Germany
Internet: www.agr-ev.de



Only genuine with the gold seal!



Please turn to page 20 for the Lattoflex mattresses with all details.

Lattoflex 200



Frame height: approx. 11 cm
 Frame width: nominal dimension minus approx. 1.1cm
 Frame length: nominal dimension minus approx. 3.0 cm



| | | |
|---------------------------|--|--|
| shoulder comfort zone | Included in the scope of supplies: 2 FB spring blocks 4 FWB spring travel limiters | |
| | | |
| | | |

Lattoflex 210



Frame height: approx. 11 cm
 Frame width: nominal dimension minus approx. 1.1cm
 Frame length: nominal dimension minus approx. 3.0 cm



| | | |
|-------------------------------------|---------------------------|--|
| head adjustment manual, 5-stage | shoulder comfort zone | Included in the scope of supplies: 2 FB spring blocks 4 FWB spring travel limiters |
| | | |
| | | |

Lattoflex 220



Frame height: approx. 11.5 cm
 Frame width: nominal dimension minus approx. 1.1 cm
 Frame length: nominal dimension minus approx. 3.0 cm
 Longitudinal support strip: max. 4.0 cm

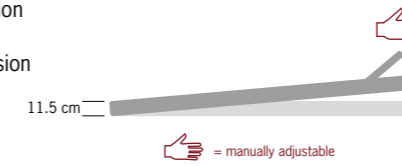

| | | |
|--|---------------------------|--|
| head adjustment manual, 5-stage | shoulder comfort zone | Reflux adjustment manual, 3-stage, approx. 2.5 cm, 7 cm, 11 cm |
| Included in the scope of supplies: 2 FB spring blocks 4 FWB spring travel limiters | | |
| | | |

Lattoflex 230



Frame height: approx. 11.5 cm
 Frame width: nominal dimension minus approx. 1.1 cm
 Frame length: nominal dimension minus approx. 3.0 cm
 Longitudinal support strip: max. 4.0 cm

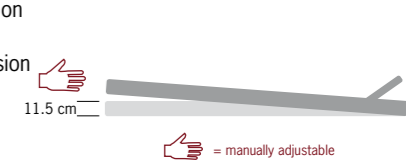

| | | |
|--|---------------------------|---|
| head adjustment manual, 5-stage | shoulder comfort zone | body inclination positioning manual, 3-stage, approx. 2.5 cm, 7 cm, 11 cm |
| Included in the scope of supplies: 2 FB spring blocks 4 FWB spring travel limiters | | |
| | | |

Standard dimensions

| | | | | | |
|-----------|---------|----------|--------------|-----|-----|
| length cm | 190/200 | width cm | 80/90/95/100 | 120 | 140 |
|-----------|---------|----------|--------------|-----|-----|

Special dimensions

Please provide precise bed inside measurements

| | | | | | |
|-----------|---------|----------|--------|---------|---------|
| length cm | 190/200 | width cm | 70-100 | 101-120 | 121-140 |
|-----------|---------|----------|--------|---------|---------|

Extra cost for special lengths between 190 and 220 cm

Accessories at a surcharge see pages 17 - 19

Please note the instructions on page 7.

Standard dimensions

| | | | | | |
|-----------|---------|----------|--------------|-----|-----|
| length cm | 190/200 | width cm | 80/90/95/100 | 120 | 140 |
|-----------|---------|----------|--------------|-----|-----|

Special dimensions

Please provide precise bed inside measurements

| | | | | | |
|-----------|---------|----------|--------|---------|---------|
| length cm | 190/200 | width cm | 70-100 | 101-120 | 121-140 |
|-----------|---------|----------|--------|---------|---------|

Extra cost for special lengths between 190 and 220 cm

Accessories at a surcharge see pages 17 - 19

Please note the instructions on page 7.

Standard dimensions

| | | | | | |
|-----------|---------|----------|--------------|-----|-----|
| length cm | 190/200 | width cm | 80/90/95/100 | 120 | 140 |
|-----------|---------|----------|--------------|-----|-----|

Special dimensions

Please provide precise bed inside measurements

| | | | | | |
|-----------|---------|----------|--------|---------|---------|
| length cm | 190/200 | width cm | 70-100 | 101-120 | 121-140 |
|-----------|---------|----------|--------|---------|---------|

Extra cost for special lengths between 190 and 220 cm

Accessories at a surcharge see pages 17 - 19

Please note the instructions on page 7.

Standard dimensions

| | | | | | |
|-----------|---------|----------|--------------|-----|-----|
| length cm | 190/200 | width cm | 80/90/95/100 | 120 | 140 |
|-----------|---------|----------|--------------|-----|-----|

Special dimensions

Please provide precise bed inside measurements

| | | | | | |
|-----------|---------|----------|--------|---------|---------|
| length cm | 190/200 | width cm | 70-100 | 101-120 | 121-140 |
|-----------|---------|----------|--------|---------|---------|

Extra cost for special lengths between 190 and 220 cm

Accessories at a surcharge see pages 17 - 19

Please note the instructions on page 7.

All sitting frames at a glance

| Model | head adjustment | shoulder comfort zone, adjustable | body inclination positioning | back adjustment | seat and knee joint adjustment, infinitely variable (parallel, pneumatic spring) | thigh adjustment | lower leg adjustment | infrared remote control unit emergency lowering |
|---|-----------------|-----------------------------------|------------------------------|----------------------|--|------------------|----------------------|--|
| Lattoflex 250 Lattoflex 251: with bedding box opening | X | X | | X manual, 6-stage | | | | |
| Lattoflex 260 | X | X | | X manual, 6-stage | | knee adjustment | | |
| Lattoflex 270 | X | X | | | X | | | |
| Motorised frames | | | | | | | | |
| Lattoflex 295 | X motorised | X | X motorised | X motorised | | X motorised | X motorised | X |
| Lattoflex 294-KS | X motorised | X | X motorised | X motorised | | X motorised | | X |
| Lattoflex 294-KU | X motorised | X | | X motorised | | X motorised | X motorised | X |
| Lattoflex 294-US | X | X | X motorised | X motorised | | X motorised | X motorised | X |
| Lattoflex 293-K | X motorised | X | | X motorised | | X motorised | | X |
| Lattoflex 293-U | X | X | | X motorised | | X motorised | X motorised | X |
| Lattoflex 293-S | X | X | X motorised | X motorised | | X motorised | | X |
| Lattoflex 292 | X | X | | X motorised | | X motorised | | X |

Please note for Lattoflex 270:

Draw belt on the left or right?

Please specify when placing your order. Standard installation is on the left (looking from the foot-end) for your right hand. Especially important for double beds or for beds placed lengthwise against the wall.

Installation dimensions

The pneumatic spring frame lowers slightly in the sitting position. In beds with longitudinal supporting beams, the supporting beam in the middle has to be removed, starting approx. 70 cm from the

head end over a length of 65 cm. If in any doubt, please contact our internal sales staff. The pneumatic spring mechanism needs an installation depth of approx. 17 cm.

Handling

The pneumatic spring makes it easier to adjust the sitting position and the knee-joint setting. However, the adjustment must always be carried out by the user shifting his/her weight. In other words, please always test this with the customer and the required mattress

Installation solutions / placing in a bed system

In designing our frames, we make sure that they are extensively compatible with the various models of bed systems available on the market. Basically, longitudinal supporting beams on the side are not a problem up to a width of 4 cm; the same also applies to triangular supports with leg lengths of up to 15 cm. When placing in a bed, we recommend an insertion depth of at least 15 to 17 cm so that the bed frame supports and holds the mattress adequately.

If necessary, please refer to the following table so that any necessary installation sets can be ordered at the same time. We give the installation recommendations for each frame type and indicate possible installation sets. Please do not hesitate to contact us in person if you have questions, or you can also contact our internal sales staff if in any doubt.

| Bed type | Lateral longitudinal supporting beams | Middle supporting beams/longitudinal frame in double beds | Triangular supports | Cross-frame beds | Beds with bedding box |
|----------------------|---|--|---|--|--|
| Lattoflex 200 | no restrictions | no restrictions | no restrictions | no restrictions | no restrictions |
| Lattoflex 210 | no restrictions | no restrictions | no restrictions | no restrictions | no restrictions |
| Lattoflex 220 | max. 4 cm | max. 8 cm | max leg length 15 cm | modify the bed frame, e.g. with triangular supports | a bedding box protruding max. 4 cm inside the bed is no problem. Otherwise remove the bedding box and modify e.g. with triangular supports |
| Lattoflex 230 | max. 4 cm | max. 8 cm | max leg length 15 cm | | |
| Lattoflex 250 | max. 4 cm | max. 8 cm | max leg length 15 cm Extension elements are needed, see page 17. | beds with cross-frames are not suitable for these frame types. Depending on bed frame suitability, check possible use of the following installation sets: stand-alone with bed side connection (see page 18) | a bedding box protruding max. 4 cm inside the bed is no problem. Otherwise remove the bedding box. Depending on bed frame suitability, check possible use of the following installation sets: stand-alone with bed side connection (see page 18) |
| Lattoflex 251 | max. 4 cm | max. 8 cm | | | |
| Lattoflex 260 | max. 4 cm | max. 8 cm | | | |
| Lattoflex 270 | max. 4 cm, must be removed in the middle (see instructions above), possibly check use of suspended bracket , page 18 | max. 8 cm, must be removed in the middle (see instructions above). See also page 18: special installation set 270 | | | |
| Lattoflex 29x | max. 4 cm | max. 8 cm | | | |

Lattoflex 250

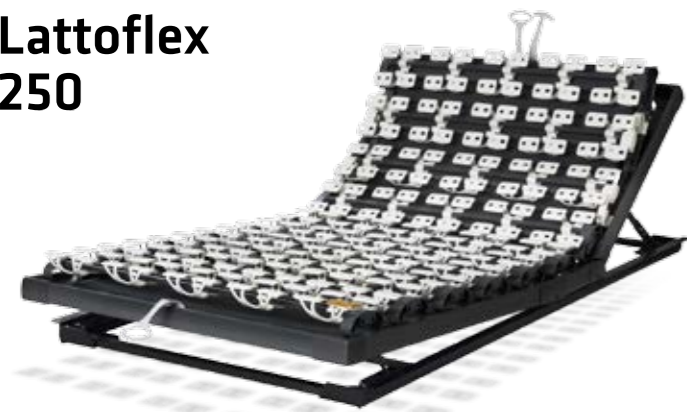

Lattoflex 251



Lattoflex 260



Lattoflex 270



The optimum function is always depending on the type of mattress and the weight of the user. Therefore: **Always test with the customer.**

| | | |
|---|--|---|
| <p>Frame height: approx. 11.5 cm Frame width: nominal dimension minus approx. 1.1 cm Frame length: nominal dimension minus approx. 3.0 cm Longitudinal support strip: max. 4.0 cm</p> <p>11,5 cm = manually adjustable, nobody should be in bed during adjustment!</p> | | |
| <p>head adjustment manual, 5-stage</p> | <p>shoulder comfort zone</p> | <p>upper part of the body adjustment, manual, 6-stage (max. approx. 40°) approx. 13 - 47 cm</p> |
| <p>To optimize the sitting position: Foot adjustment, 3-stage, approx. 2.5 cm, 7 cm, 11 cm</p> | <p>Included in the scope of supplies: 2 FB spring blocks 4 FWB spring travel limiters</p> | |

| | | |
|---|---|--|
| <p>Frame height: approx. 11.5 cm Frame width: nominal dimension minus approx. 1.1 cm Frame length: nominal dimension minus approx. 3.0 cm Longitudinal support strip: max. 4.0 cm</p> <p>11,5 cm = manually adjustable, nobody should be in bed during adjustment!</p> | | |
| <p>head adjustment manual, 5-stage</p> | <p>shoulder comfort zone</p> | <p>upper part of the body adjustment, manual, 6-stage (max. approx. 40°) approx. 13 - 47 cm</p> |
| <p>To optimize the sitting position: Foot adjustment, 3-stage, approx. 2.5 cm, 7 cm, 11 cm</p> | <p>bedding box opening with pneumatic springs opening angle 30° (approx. 80 cm)</p> | <p>Included in the scope of supplies: 2 FB spring blocks 4 FWB spring travel limiters</p> |

| | | |
|---|---|--|
| <p>Frame height: approx. 11.5 cm Frame width: nominal dimension minus approx. 1.1 cm Frame length: nominal dimension minus approx. 3.0 cm Longitudinal support strip: max. 4.0 cm</p> <p>11,5 cm = manually adjustable, nobody should be in bed during adjustment!</p> | | |
| <p>head adjustment manual, 5-stage</p> | <p>shoulder comfort zone</p> | <p>upper part of the body adjustment, manual, 6-stage (max. approx. 40°) approx. 13 - 47 cm</p> |
| <p>knee adjustment manual, 3-stage</p> <p>approx. 2.5 cm, 7.5 cm, 12.5 cm</p> | <p>Lower leg lifting, manual, 3-stage, as addendum to knee adjustment</p> | <p>Included in the scope of supplies: 2 FB spring blocks 4 FWB spring travel limiters</p> |

| | | |
|--|------------------------------|--|
| <p>Frame height: approx. 11.5 cm Frame width: nominal dimension minus approx. 1.1 cm Frame length: nominal dimension minus approx. 3.0 cm Inlay depth approx. 17 cm Highest setting angle for upper part of the body adjustment: approx. 50°</p> <p>11,5 cm 17,0 cm adjustable by shifting of weight</p> | | |
| <p>head adjustment manual, 5-stage</p> | <p>shoulder comfort zone</p> | <p>seat and knee joint adjustment infinitely variable (parallel, pneumatic spring)</p> |
| <p>Included in the scope of supplies: 2 FB spring blocks 4 FWB spring travel limiters</p> | | |

Standard dimensions

| | | | | | |
|-----------|---------|----------|--------------|-----|-----|
| length cm | 190/200 | width cm | 80/90/95/100 | 120 | 140 |
|-----------|---------|----------|--------------|-----|-----|

Standard dimensions

| | | | | | |
|-----------|-----|----------|--------------|-----|-----|
| length cm | 200 | width cm | 80/90/95/100 | 120 | 140 |
|-----------|-----|----------|--------------|-----|-----|

Standard dimensions

| | | | | | |
|-----------|---------|----------|--------------|-----|-----|
| length cm | 190/200 | width cm | 80/90/95/100 | 120 | 140 |
|-----------|---------|----------|--------------|-----|-----|

Standard dimensions

| | | | | | |
|-----------|---------|----------|--------------|-----|-----|
| length cm | 190/200 | width cm | 80/90/95/100 | 120 | 140 |
|-----------|---------|----------|--------------|-----|-----|

Special dimensions

Please provide precise bed inside measurements

| | | | | | |
|-----------|---------|----------|--------|---------|---------|
| length cm | 190/200 | width cm | 70-100 | 101-120 | 121-140 |
|-----------|---------|----------|--------|---------|---------|

Extra cost for special lengths between 190 and 220 cm

Special dimensions

Please provide precise bed inside measurements

| | | | | | |
|-----------|-----|----------|--------|---------|---------|
| length cm | 200 | width cm | 70-100 | 101-120 | 121-140 |
|-----------|-----|----------|--------|---------|---------|

Extra cost for special lengths between 200 and 220 cm

Special dimensions

Please provide precise bed inside measurements

| | | | | | |
|-----------|---------|----------|--------|---------|---------|
| length cm | 190/200 | width cm | 70-100 | 101-120 | 121-140 |
|-----------|---------|----------|--------|---------|---------|

Extra cost for special lengths between 190 and 220 cm

Special dimensions

Please provide precise bed inside measurements

| | | | | | |
|-----------|---------|----------|--------|---------|---------|
| length cm | 190/200 | width cm | 70-100 | 101-120 | 121-140 |
|-----------|---------|----------|--------|---------|---------|

Extra cost for special lengths between 190 and 220 cm

Accessories at a surcharge
see pages 17 - 19

Please note the instructions on page 7.

Accessories at a surcharge
see pages 17 - 19

Please note the instructions on page 7.

Accessories at a surcharge
see pages 17 - 19

Please note the instructions on page 7.

Accessories at a surcharge
see pages 17 - 19

Please note the instructions on page 7.

Motor frames

Please note the instructions on page 15!

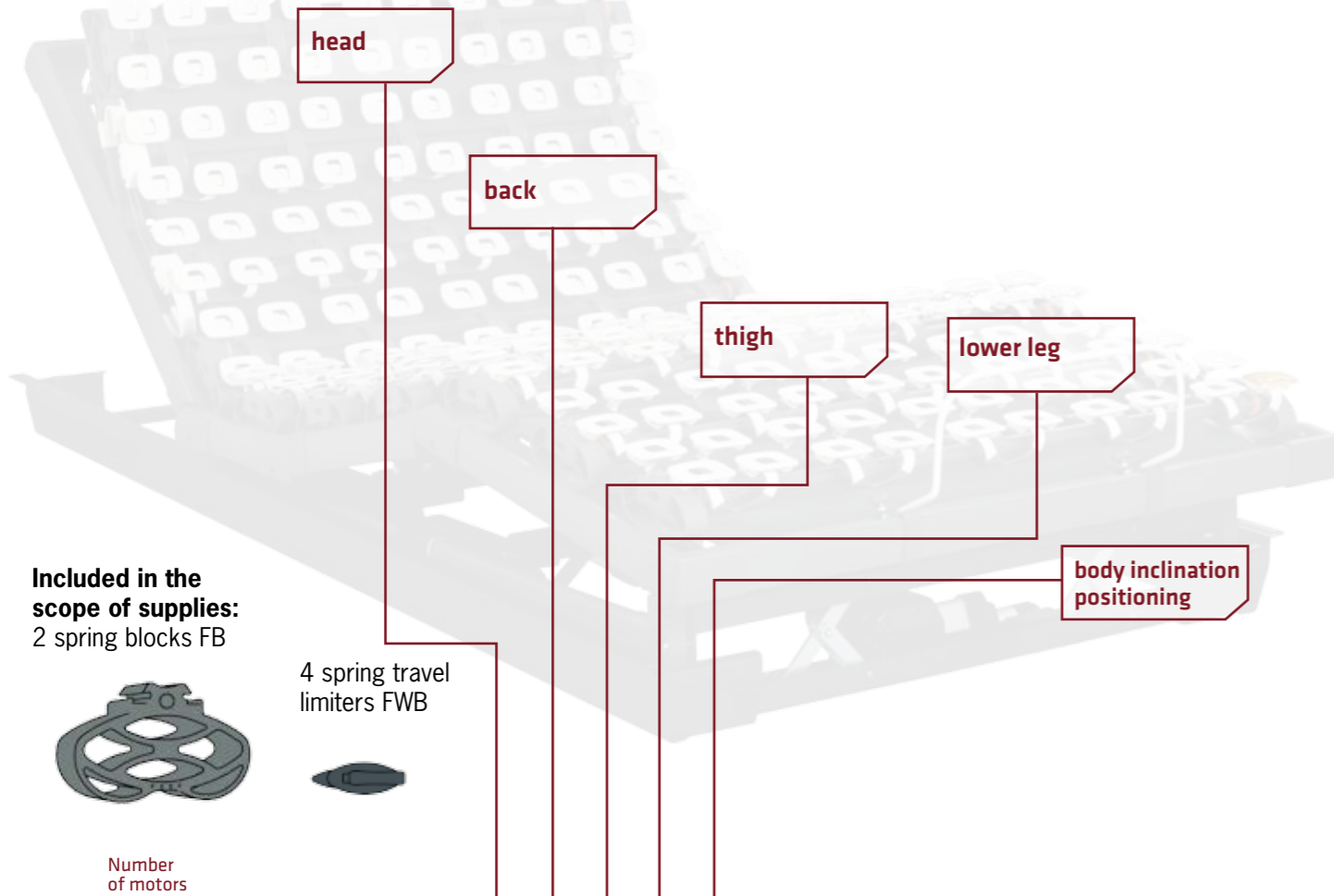

Included in the scope of supplies:
2 spring blocks FB

4 spring travel limiters FWB

Number of motors

| Number of motors | Model | Head | Back | Thigh | Lower leg | Body inclination |
|------------------|------------------|------|------|-------|-----------|------------------|
| 2 | Lattoflex 292 | Hand | M | M | | |
| 3 | Lattoflex 293-U | Hand | M | M | M | |
| 3 | Lattoflex 293-S | Hand | M | M | | M |
| 3 | Lattoflex 293-K | | M | M | M | |
| 4 | Lattoflex 294-US | Hand | M | M | M | M |
| 4 | Lattoflex 294-KS | | M | M | M | M |
| 4 | Lattoflex 294-KU | | M | M | M | M |
| 5 | Lattoflex 295 | | M | M | M | M |

Hand manual head adjustment

M motorised function



All Lattoflex 200 motor frames are equipped with the new intelligent radio remote control as a standard feature. The radio connection between motor frame and remote control on both sides offers new possibilities. The remote control only shows those motors and options that are actually fitted to the motor frame, without any empty displays or empty buttons. It shows the exact position of all adjustable parts at any time.

Other features:

- Reliable radio connection, visual contact between transmitter and receiver is not necessary
- 6 memory buttons for quick access to the favourite positions
- The buttons light up when the remote control is moved
- Integrated torch function
- Control prepared for further options (see page 16)
- Storage pocket in felt look (see page 16)

As an option, the motor frames can be controlled by Smartphone using the Lattoflex app, see accessories, page 16.

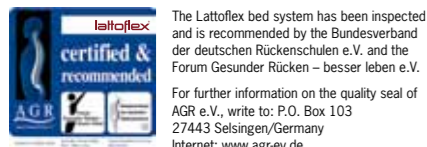

The Lattoflex bed system has been inspected and is recommended by the Bundesverband der deutschen Rückenschulen e.V. and the Forum Gesunder Rücken – besser leben e.V. For further information on the quality seal of AGR e.V., write to: P.O. Box 103 27443 Selsingen/Germany Internet: www.agr-ev.de

Lattoflex 295



Lattoflex 294-KS



Frame height: approx. 11.5 cm
Frame width: nominal dimension minus approx. 1.1 cm
Frame length: nominal dimension minus approx. 3.0 cm
Inlay depth: approx. 13 cm

| | | |
|---|--|---|
| infinitely variable head adjustment motorised | shoulder comfort zone | back adjustment motorised (max. approx. 50°) |
| thigh adjustment motorised | lower leg adjustment motorised | infinitely variable body inclination positioning, motorised |
| remote control unit with 6 memory functions | emergency lowering device in case of loss of electricity (battery) | mattress holder at foot-end |

Standard dimensions

| | | | | | |
|-----------|---------|----------|--------------|-----|-----|
| length cm | 190/200 | width cm | 80/90/95/100 | 120 | 140 |
|-----------|---------|----------|--------------|-----|-----|

Special dimensions

Please provide precise bed inside measurements

| | | | | | |
|-----------|---------|----------|--------|---------|---------|
| length cm | 190/200 | width cm | 75-100 | 101-120 | 121-140 |
|-----------|---------|----------|--------|---------|---------|

Extra cost for special lengths between 190 and 220 cm
3-year motor warranty

Hand manually adjustable
M motorised adjustable

Accessories at a surcharge
see pages 16 - 19

Please note the instructions on page 7 and 15.

Frame height: approx. 11.5 cm
Frame width: nominal dimension minus approx. 1.1 cm
Frame length: nominal dimension minus approx. 3.0 cm
Inlay depth: approx. 13 cm

| | | |
|--|---|--|
| infinitely variable head adjustment motorised | shoulder comfort zone | back adjustment motorised (max. approx. 50°) |
| thigh adjustment motorised | infinitely variable body inclination positioning, motorised | remote control unit with 6 memory functions |
| emergency lowering device in case of loss of electricity (battery) | mattress holder at foot-end | |

Standard dimensions

| | | | | | |
|-----------|---------|----------|--------------|-----|-----|
| length cm | 190/200 | width cm | 80/90/95/100 | 120 | 140 |
|-----------|---------|----------|--------------|-----|-----|

Special dimensions

Please provide precise bed inside measurements

| | | | | | |
|-----------|---------|----------|--------|---------|---------|
| length cm | 190/200 | width cm | 75-100 | 101-120 | 121-140 |
|-----------|---------|----------|--------|---------|---------|

Extra cost for special lengths between 190 and 220 cm
3-year motor warranty

Hand manually adjustable
M motorised adjustable

Accessories at a surcharge
see pages 16 - 19

Please note the instructions on page 7 and 15.

Lattoflex 294-KU



Lattoflex 294-US



Lattoflex 293-K



Lattoflex 293-U

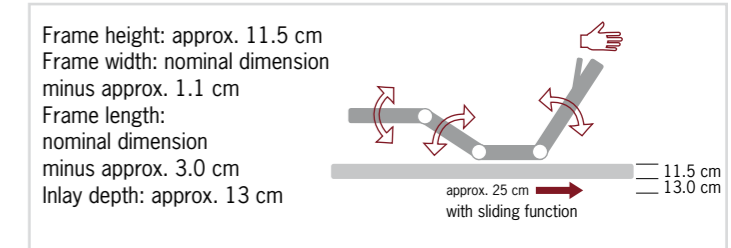
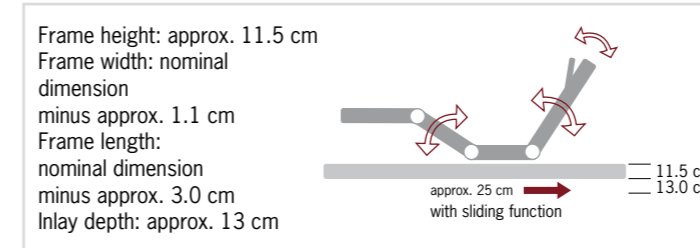
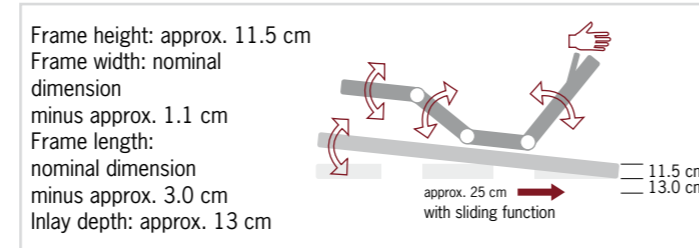
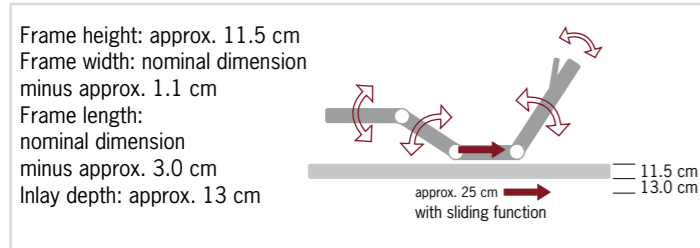
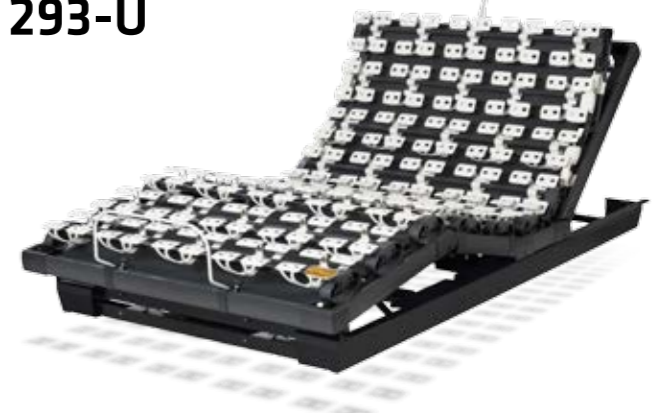

| | | |
|--|--------------------------------|--|
| infinitely variable head adjustment motorised | shoulder comfort zone | back adjustment motorised (max. approx. 50°) |
| thigh adjustment motorised | lower leg adjustment motorised | remote control unit with 6 memory functions |
| emergency lowering device in case of loss of electricity (battery) | mattress holder at foot-end | |

| | | |
|---|--|---|
| head adjustment manual, 5-stage | shoulder comfort zone | back adjustment motorised (max. approx. 50°) |
| thigh adjustment motorised | lower leg adjustment motorised | infinitely variable body inclination positioning, motorised |
| remote control unit with 6 memory functions | emergency lowering device in case of loss of electricity (battery) | mattress holder at foot-end |

| | | |
|---|---|--|
| infinitely variable head adjustment motorised | shoulder comfort zone | back adjustment motorised (max. approx. 50°) |
| thigh adjustment motorised | remote control unit with 6 memory functions | emergency lowering device in case of loss of electricity (battery) |
| mattress holder at foot-end | | |

| | | |
|--|--------------------------------|--|
| head adjustment manual, 5-stage | shoulder comfort zone | back adjustment motorised (max. approx. 50°) |
| thigh adjustment motorised | lower leg adjustment motorised | remote control unit with 6 memory functions |
| emergency lowering device in case of loss of electricity (battery) | mattress holder at foot-end | |

Standard dimensions

| | | | | | |
|-----------|---------|----------|--------------|-----|-----|
| length cm | 190/200 | width cm | 80/90/95/100 | 120 | 140 |
|-----------|---------|----------|--------------|-----|-----|

Standard dimensions

| | | | | | |
|-----------|---------|----------|--------------|-----|-----|
| length cm | 190/200 | width cm | 80/90/95/100 | 120 | 140 |
|-----------|---------|----------|--------------|-----|-----|

Standard dimensions

| | | | | | |
|-----------|---------|----------|--------------|-----|-----|
| length cm | 190/200 | width cm | 80/90/95/100 | 120 | 140 |
|-----------|---------|----------|--------------|-----|-----|

Standard dimensions

| | | | | | |
|-----------|---------|----------|--------------|-----|-----|
| length cm | 190/200 | width cm | 80/90/95/100 | 120 | 140 |
|-----------|---------|----------|--------------|-----|-----|

Special dimensions

Please provide precise bed inside measurements

| | | | | | |
|-----------|---------|----------|--------|---------|---------|
| length cm | 190/200 | width cm | 75-100 | 101-120 | 121-140 |
|-----------|---------|----------|--------|---------|---------|

Extra cost for special lengths between 190 and 220 cm
3-year motor warranty



Accessories at a surcharge
 see pages 16 - 19

Please note the instructions on page 7 and 15.

Special dimensions

Please provide precise bed inside measurements

| | | | | | |
|-----------|---------|----------|--------|---------|---------|
| length cm | 190/200 | width cm | 75-100 | 101-120 | 121-140 |
|-----------|---------|----------|--------|---------|---------|

Extra cost for special lengths between 190 and 220 cm
3-year motor warranty



Accessories at a surcharge
 see pages 16 - 19

Please note the instructions on page 7 and 15.

Special dimensions

Please provide precise bed inside measurements

| | | | | | |
|-----------|---------|----------|--------|---------|---------|
| length cm | 190/200 | width cm | 75-100 | 101-120 | 121-140 |
|-----------|---------|----------|--------|---------|---------|

Extra cost for special lengths between 190 and 220 cm
3-year motor warranty



Accessories at a surcharge
 see pages 16 - 19

Please note the instructions on page 7 and 15.

Special dimensions

Please provide precise bed inside measurements

| | | | | | |
|-----------|---------|----------|--------|---------|---------|
| length cm | 190/200 | width cm | 75-100 | 101-120 | 121-140 |
|-----------|---------|----------|--------|---------|---------|

Extra cost for special lengths between 190 and 220 cm
3-year motor warranty



Accessories at a surcharge
 see pages 16 - 19

Please note the instructions on page 7 and 15.

Lattoflex 293-S



Lattoflex 292



Optional:
Simple button switch for Lattoflex 292 (without surcharge). Please state with order.

Frame height: approx. 11.5 cm
Frame width: nominal dimension minus approx. 1.1 cm
Frame length: nominal dimension minus approx. 3.0 cm
Inlay depth: approx. 13 cm

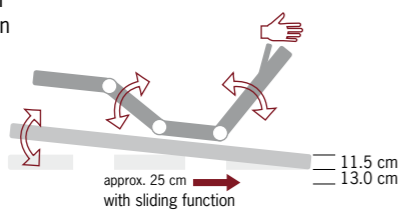

| | | |
|--|--|--|
| head adjustment manual, 5-stage | shoulder comfort zone | back adjustment motorised (max. approx. 50°) |
| thigh adjustment motorised | infinitely variable inclination positioning, motorised | remote control unit with 6 memory functions |
| emergency lowering device in case of loss of electricity (battery) | mattress holder at foot-end | |

Standard dimensions

| | | | | | |
|-----------|---------|----------|--------------|-----|-----|
| length cm | 190/200 | width cm | 80/90/95/100 | 120 | 140 |
|-----------|---------|----------|--------------|-----|-----|

Special dimensions

Please provide precise bed inside measurements

| | | | | | |
|-----------|---------|----------|--------|---------|---------|
| length cm | 190/200 | width cm | 75-100 | 101-120 | 121-140 |
|-----------|---------|----------|--------|---------|---------|

Extra cost for special lengths between 190 and 220 cm
3-year motor warranty



Accessories at a surcharge
see pages 16 - 19

Please note the instructions on page 7 and 15.

Frame height: approx. 11.5 cm
Frame width: nominal dimension minus approx. 1.1 cm
Frame length: nominal dimension minus approx. 3.0 cm
Inlay depth: approx. 13 cm

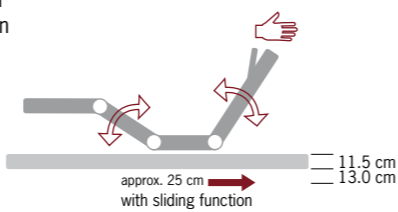

| | | |
|--|---|---|
| head adjustment manual, 5-stage | shoulder comfort zone | back adjustment motorised (max. approx. 50°) |
| thigh adjustment motorised | remote control unit with 6 memory functions | Optional for Lattoflex 292: Simple button switch with restricted functions (no memory function, control of accessories is not possible). |
| emergency lowering device in case of loss of electricity (battery) | mattress holder at foot-end | |

Standard dimensions

| | | | | | |
|-----------|---------|----------|--------------|-----|-----|
| length cm | 190/200 | width cm | 80/90/95/100 | 120 | 140 |
|-----------|---------|----------|--------------|-----|-----|

Special dimensions

Please provide precise bed inside measurements

| | | | | | |
|-----------|---------|----------|--------|---------|---------|
| length cm | 190/200 | width cm | 75-100 | 101-120 | 121-140 |
|-----------|---------|----------|--------|---------|---------|

Extra cost for special lengths between 190 and 220 cm
3-year motor warranty



Accessories at a surcharge
see pages 16 - 19

Please note the instructions on page 7 and 15.

Please note for all motor frames:

At the head-end, the frame needs a clear height of approx. 70 cm plus the mattress height, measured from the supporting point of the longitudinal beam. This is important, e.g., with inclined roofs or shelves.

Installation depth of approx. 13 cm in the substructure is required for the adjustment mechanism and for the drive system.

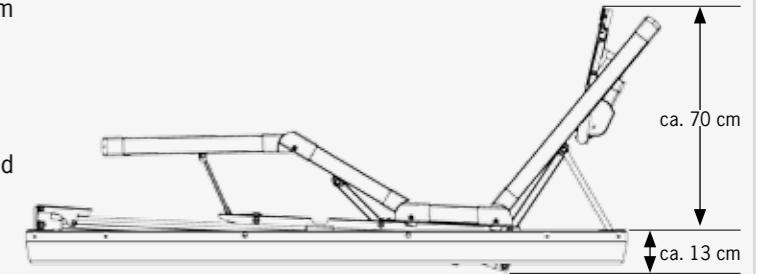

Please take account of the following details when advising your customer:

- Please point out to your customer that the use of one frame (e.g. 140 cm width) by two persons will not be suitable for their backs!
- The motor frames are designed for longitudinal supporting beams of max. 4 cm (longitudinal middle beams for double beds: max. 8 cm).
- For installation in beds, we need to know the clear inside measurements of the bed (important for special dimensions). We will then calculate the corresponding frame size.
- Triangular supports should have a leg length of 15 cm. If in any doubt, please contact our internal sales staff.
- Ideal adjustment to the user's body and perfect functioning of all adjustment parts is only achieved when using a Lattoflex mattress.
- Advise your customers to purchase fitted/fix sheets for sitting frames.
- Upon delivery, please advise your customer to read the operating instructions and to keep them in a safe place.

Notes

Accessories for motor frames at a surcharge

Electrical hot water bottle

Used directly on the mattress. Connected to the motor frame and controlled with the Lattoflex remote control. This makes it easy to adjust the heating time (up to max. 60 min) and heating intensity, which can also be saved as favourite settings. One electrical hot water bottle can be connected to each motor frame.

Output: 50 watt / cable length approx. 3.20 m
 Safe low voltage: 24V
 Core of Lattoflex Evopor foam with tricot fabric, approx. 2.5 cm high.
 The cover is made of highly permeable spacer fabric and can be removed and washed.
 (Fabric: 63% polyester, 20% polypropylene, 17% viscose)



LED underbed lighting

Dimmable light strip with 6 individual LEDs. Provides subdued guidance light. Connected to the motor frame and controlled with the Lattoflex remote control. This makes it easy to adjust the timer function and luminosity, which can also be saved as favourite settings. We recommend fitting the light strip under the bed or under the side of the bed. Including installation materials for screwing and adhering.

Cable length; approx. 2.0 m
 Output: 1.65 watt
 Dimensions: 16 cm / 2 cm / 1.2 cm (l x w x h)



Pocket for the remote control

The pocket in black felt look can be wrapped around the side of the bed. With elastic gusset to fit circumferences of up to approx. 58 cm. The pocket is sewn in such a way that it is always slightly open to make it easy to insert the Lattoflex remote control. For safe, easily accessible storage of your Lattoflex remote control.
 Black, 100% polyester, washable
One pocket is included with every motor frame as a standard feature.

Socket receiver

Up to 6 socket receivers can be controlled separately by each remote control. For consumers with up to 460 watt output. Safety fuse accessible from the outside. Can only be controlled by the new Lattoflex remote control (from model year 2013). A motor frame is not necessary for the socket receiver to work.

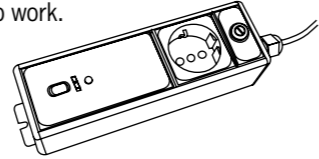

Smart Remote

The Smart Remote connects your network (LAN or Wi-Fi) to the Lattoflex motor frame. Use the Lattoflex app (on the right) to control all the functions of your motor frame from many Smartphones or tablet PCs, as long as you are within your network range. The Smart Remote needs a power connection and a network cable (LAN cable) for connection to your Wi-Fi. Several motor frames can be controlled individually by one Smart Remote.

Range (maximum distance from the motor frame): 10 m

Lattoflex App

This program gives you easy control of your motor frame from your iPhone, iPad or android device. Together with a compatible Smartphone or tablet, it requires a stable Wi-Fi network and the Smart Remote adapter (on the left). For details about the app, please refer to the corresponding provider pages. Search for the Lattoflex app or simply follow the QR code which contains the direct link:



free of charge

Accessories for all frames at a surcharge

Spring blocks FB / Spring travel limiters FWB

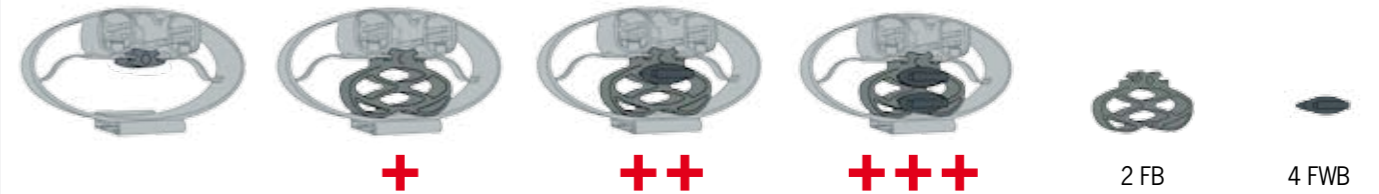

Use the spring blocks (FB) to adjust the Lattoflex spring base to your customer's individual needs, e.g. to relieve a hollow back. In addition, the spring travel limiters (FWB) can be inserted (or removed later) for fine tuning. 2 FBs and 4 FWBs are included with every spring base as a standard feature.

1 set consists of 2 FBs and 4 FWBs

Mattress holders

Mattress holders prevent the mattress from slipping on bed frames that don't offer sufficient depth to hold the mattress properly. For sitting frames, one mattress holder at the foot end already prevents the mattress from slipping lengthwise. Can be retrofitted. All motor frames are supplied with one mattress holder as a standard feature.

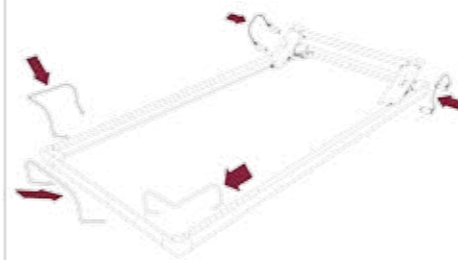

MH foot

For mounting to cross bars at the foot end of all frame types (can also be fitted to the head end if necessary). All motor frames are supplied with one mattress holder as a standard feature.



Suitable for all spring base types.

Metal, creamy white, 1 pc.

MH corner foot

For mounting across the corner, only at the foot end. Gives the mattress lengthwise and crosswise hold at the foot end. Can be used instead of MH foot.



For all spring base types, from Lattoflex 260 only from lengths of 200 cm.

Metal, creamy white, 1 set contains 2 pcs.

MH side head

For mounting to the side at the head end.



For all spring base types from Lattoflex 210.

Metal, creamy white, 1 set contains 2 pcs.

Extension elements

Needed for beds with triangular supports (leg length max. 15 cm).

Only for spring base types from Lattoflex 250 in beds with triangular supports

Adjustment foot VF

Support foot to vary the height for many possible applications. One VF foot is already included in the installation set for longitudinal frames.

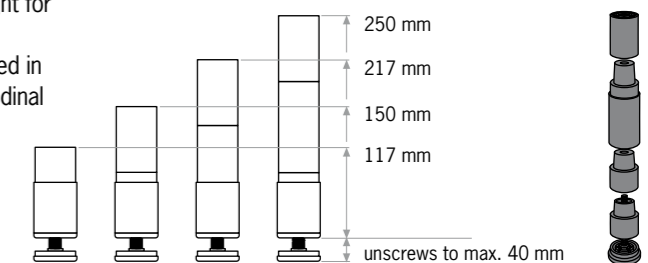

Stand Alone

All spring bases can be put on their own feet as a stand-alone solution. For all frames from type 250 to 295, the required foot solution is simply screwed to the existing metal base. For types 200 to 230 there is a metal sub-frame with round feet.

All foot variations shown here give a sitting height of approx. 58 cm from the floor to the upper edge of the Lattoflex mattress.

Feet Q and R are available in special heights on request.

Equipped in this way, every spring base can be used as a stand-alone solution. As an option, an existing bed body can be attached to the Lattoflex spring base from types 250 using the accessory set „bed side connection“ (below).

| Frame type | Scope of delivery | Feet R | Feet Q | Skids K |
|------------------------------|---|--------|--------|---------|
| 200 | Sub-frame with round feet (foot height = 25 cm) | ● | - | - |
| 210 | | | | |
| 220 | | | | |
| 250 | Foot solution (foot height = 22.5 cm) | ● | ● | ● |
| 251 | | | | |
| 260 | | | | |
| 270 | | | | |
| Motor frame 292 - 295 | Foot solution (foot height = 17.5 cm) | ● | ● | ● |

Suspended bracket

Use this set to prepare bed frames that don't have the necessary fittings so that they can take the Lattoflex spring base. The base plates (14 cm high) are screwed into the bed frame and the brackets suspended at the required height. 3 height settings: 0 – 24 mm – 48 mm – 72 mm

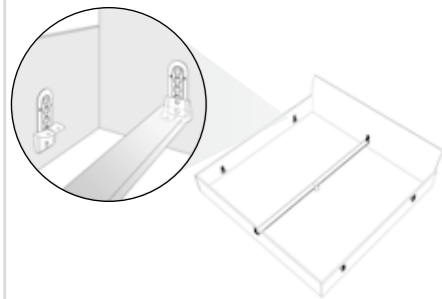

1 set contains 4 pcs.

Longitudinal frame installation set

For double beds without middle beam. Consisting of 1 longitudinal frame (70 mm wide), 2 suspended brackets, 1 adjustable foot VF and screws. The suspended brackets make it possible to adjust the height of the longitudinal frame.

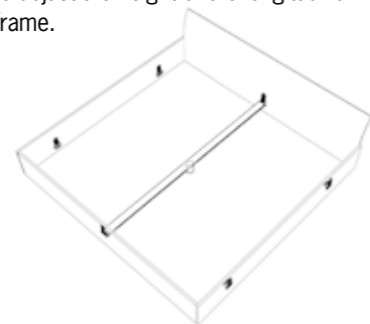

Lengths 190/200/210/220 cm

Special longitudinal frame installation set for frame 270

Here the longitudinal support is interrupted so that frame 270 can be lowered in the middle. Consisting of 2 frame sections, 2 suspended brackets, 2 adjustable feet VF and screws.

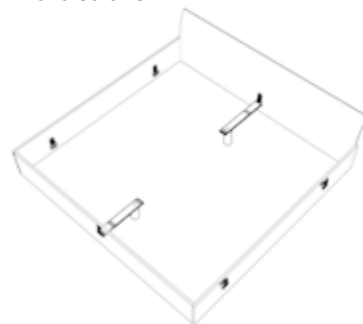

Bed side connection

These adapters make it possible to fit an existing wooden bed frame to the Lattoflex spring base without needing a foot solution.

Can be used for all frames from type 250 with „stand-alone“ foot solution.

1 set contains 4 adapters for bed side connection

For double beds, the bed connection also has to be fitted. This holds the two beds together in position.

1 set contains 2 bed connectors

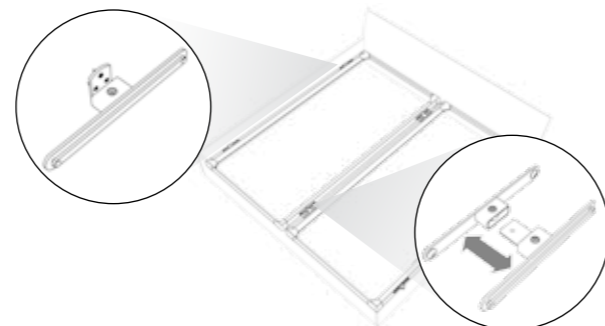

Fitted undersheet

The Lattoflex fitted undersheet is inserted between the base frame and the spring base. It acts as an elegant anthracite cover for all functional parts, e.g. rods and drive systems for motor frames,

while drawing attention to the spring base itself. Recommended especially for shop presentation.



without fitted undersheet



with fitted undersheet

Standard fitted undersheet available for all spring base types with dimensions 90/200 and 100/200. All other widths and special lengths on request.

Zone adjustment ZV

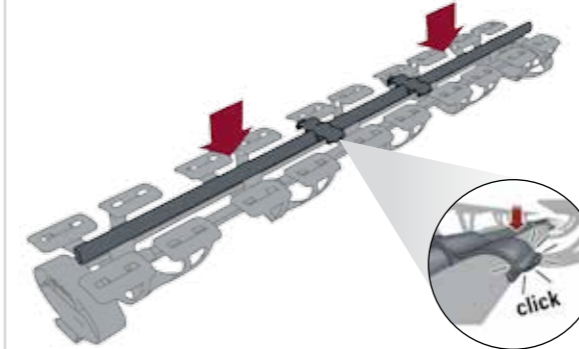

The zone adjustment ZV can be used to increase the load rating of individual double sections.

We recommend the installation of several supporting strips in the main load area for heavier persons or those who prefer to lie on a firmer base.

The zone adjustment is easily fitted in every Lattoflex 200 spring base without needing any tools.

Please state frame width with order

Spare parts for Lattoflex 200 frames

for frames from February 2000 to May 2003

Replacement set
Spring elements with dowel plates, for converting a complete bed surface.
Scope of supply:
24 dowel plates
20 normal spring elements and 4 shoulder spring elements incl. screws

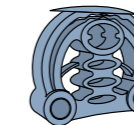

for all frames until March 2013

supporting strip, pale grey
Please state frame type, include frame type, model year and width with order

Attention! Special supporting strips are needed for the shoulder zone



to 100 cm
to 120 cm
to 140 cm

for all frames until April 2007

spring element



Lattoflex 200 wing element

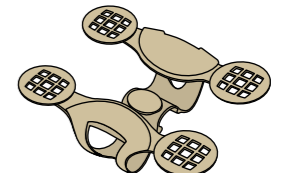

spring element/shoulder

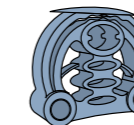

All other individual parts, also for older frames, available on request.

Lattoflex mattresses:

Lattoflex's basic idea of offering one mattress core in modules of different strengths has proven its worth now for more than 10 years. This modular cut offers the inclined body exactly the support it needs.

Five mattress cores cover almost all the comfort demands made by customers. The current generation of Lattoflex mattresses is cuddlier, more comfortable, thicker, more permeable and variable than ever before.

Nearly all covers are now available in two finishes: climate stripe or climate border.

- larger and more comfortable shoulder zone
- climate stripe or climate border for better ventilation
- Extremely breathable with open-pored ClimaCell® foam and broken-up surface
- Ideal addition to comfort sitting frames
- Different materials for nearly all demands
- Covers can be easily removed for washing or cleaning



ClimaCell® from Lattoflex:

ClimaCell® was specifically developed for Lattoflex. The material is known for high point-elasticity, extremely good breathing properties and optimum suitability for persons allergic to household dust.

Optimum adaptation:

Due to the extremity-shaped cut and the loosened-up surface, these mattresses adapt themselves ideally to suit the body contour of the lying person. And the lack of surface tension is also experienced as being extremely pleasant by lightweight persons, too. These properties make our Lattoflex mattresses the ideal supplement for our comfort sitting frames.

For a pleasant lying sensation:

The new surface section increases the affectionate nature and creates a noticeable improved feeling. The thereby improved, extraordinary point-elasticity ensures an ideal adaptation to the body.

The material is extremely breathable and is thereby responsible for the typical dry-warm bed climate of Lattoflex mattresses.



Optimum adaptation:

Due to the extremity-shaped cut and the loosened-up surface, these mattresses adapt themselves ideally to suit the body contour of the lying person. And the lack of surface tension is also experienced as being extremely pleasant by lightweight persons, too. These properties make our Lattoflex mattresses the ideal supplement for our Comfort sitting frames.



The Lattoflex bed system has been inspected and is recommended by the Bundesverband der deutschen Rückenschulen e.V. and the Forum Gesunder Rücken – besser leben e.V.

For further information on the quality seal of AGR e.V., write to: P.O. Box 103 27443 Selsingen/Germany Internet: www.agr-ev.de



Tested for harmful substances according to Oeko-Tex® Standard 100 A97-0400 Hohenstein for mattresses

All Lattoflex mattresses and the neck supporting cushions have been inspected in accordance with the Öko-Tex Standard 100. Accordingly, the certified human-ecological harmlessness refers, of course, also to the ClimaCell® mattress cores or the cushion fillings.



Tested for harmful substances according to Oeko-Tex® Standard 100 A98-0331 Hohenstein for cushions

Classic 1



The two Classic mattress cores are the entry level price category and available in two different hardnesses. Classic 1 is the soft version. The basic models also have the elaborate limbs cut with excellent functionality particularly on adjustable frames. The shoulder zone is integrated in the cut while the proven climate wave on the surface provides for relaxed lying and sleeping.

Material



Mattress core: ClimaCell®, Tricot knitted fabric: 100 % polyester
Core height: approx. 17 cm

Classic 2



The two Classic mattress cores are the entry level price category and available in two different hardnesses. Classic 2 is the firm version. The basic models also have the elaborate limbs cut with excellent functionality particularly on adjustable frames. The shoulder zone is integrated in the cut while the proven climate wave on the surface provides for relaxed lying and sleeping.

Material



Mattress core: ClimaCell®, Tricot knitted fabric: 100 % polyester
Core height: approx. 17 cm

Sensiv



Our softest core is especially meant for petite, slim and lightweight people with sensible sleeping needs. Shoulder zone for pleasant sinking-in of the shoulder, especially when lying on the side.

Material

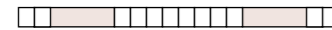

Mattress core: ClimaCell®, Tricot knitted fabric: 100 % polyester
Core height: approx. 17 cm

Medium



With its firmer middle part than the Sensiv core, the Lattoflex Medium core is the first choice for many people. Shoulder zone for pleasant sinking-in of the shoulder, especially when lying on the side.

Material



Mattress core: ClimaCell®, Tricot knitted fabric: 100 % polyester
Core height: approx. 17 cm

Compact



Meant for persons who like a more firm mattress. The comfortable shoulder zone ensures a pleasant sinking-in when sleeping on the side. This is felt explicitly due to the firmer middle part of the core.

Material



Mattress core: ClimaCell®, Tricot knitted fabric: 100 % polyester
Core height: approx. 17 cm

Please note:

Upsize widths with double beds

Please note when purchasing: Mattresses with oversize widths (160, 180, 200 cm) are very unhandy and unsuitable for adjustable frames. Even head adjustments can no longer be adjusted to individual requirements. Your customer will also need bed linen/fixed linen sheets in special sizes.

Special widths exceeding 160 cm include two individual mattress cores in one cover.

Make sure the mattress matches the inlay frame.

When using a new mattress on an old, used frame, the mattress could become damaged in a relatively short period of time. In case of such a combination, no warranty claims can be asserted.



Lattokiss

the physiologically designed neck supporting cushion



This cushion is individually adjustable with respect to shape and supporting force. It supports your neck and relieves your especially sensitive neck vertebrae.

Dimension/Material

Dimension: approx. 35 x 80 cm
Cover: 100 % cotton
Filling: Microfibre 100 % polyester, 450 g washable 60°C/140°F, suitable for drier

Traumfalter

the cushion with the bolster



We have folded the classic format 80 x 80 cm and fixed it with a zipper. In this condition, the cushion has the right volume. And for the support of the neck, you can insert either one or two bolsters.

Dimension/Material

Dimension: approx. 35 x 80 cm
Cover: 100 % cotton
Filling: Microfibre 100 % polyester, 480 g washable 60°C/140°F, suitable for drier

Jersey J



Extremely point-elastic Jersey material in valuable optic. Heavy "double-cloth" quality.

Features:

zipper 2-side

Overall height: approx. 17 cm

Cover fabric:

70 % polyester, 30 % viscose (bamboo), washable 60°C/140°F, not suitable for drier

Standard dimensions

| lengths cm | 190/200 | width cm | 80/90/95/100 | 120 | 140 | 70-100 | 101-120 | 121-140 | 141-160 | 161-200 |
|------------|---------|----------|--------------|-----|-----|--------|---------|---------|---------|---------|
|------------|---------|----------|--------------|-----|-----|--------|---------|---------|---------|---------|

Special lengths up to 200 cm at no extra cost. Extra cost for special lengths (with all widths) between 200 and 220 cm.

Curved mattresses at extra cost. Please specify the precise radius or send us pattern.

Special dimensions Please provide precise bed inside measurements

Jersey IS with climate stripe



A synthetic cover stitched with comfort pad foam, due to its washability (up to 60°C/140°F) also ideal for persons allergic to household dust and persons suffering from asthma. Here we use a fibre that distributes the moisture on the fibre surface and lets it evaporate very quickly. This property is maintained for a long time even after washing the material frequently. Accordingly, we have succeeded in giving the synthetic fibre a "natural feeling". The included carbon fibre has an antistatic and dust repelling effect.

Features:

4 robust turning handles, zipper all the way round, climate stripe

Overall height: approx. 20 cm

Cover fabric:

Outer material: 45 % polyamide, 35 % viscose (bamboo), 20 % polyester
 Stitched filling: 550 g/m² comfort pad PU-foam
 Bottom fabric: 100 % polyamide
 washable at 60°C/140°F, not suitable for drier

Standard dimensions

| lengths cm | 190/200 | width cm | 80/90/95/100 | 120 | 140 | 70-100 | 101-120 | 121-140 | 141-160 | 161-200 |
|------------|---------|----------|--------------|-----|-----|--------|---------|---------|---------|---------|
|------------|---------|----------|--------------|-----|-----|--------|---------|---------|---------|---------|

Special lengths up to 200 cm at no extra cost. Extra cost for special lengths (with all widths) between 200 and 220 cm.

Curved mattresses at extra cost. Please specify the precise radius or send us pattern.

Special dimensions Please provide precise bed inside measurements

Jersey CS with climate stripe



Cover material that is pleasant to touch thanks to top quality cashmere fibres. The material also includes carbon threads that have an anti-static and dust-repellent effect.

Features:

4 robust turning handles, zipper all the way round, climate stripe

Overall height: approx. 20 cm

Cover fabric:

Outer material: 56 % polyester, 35 % viscose (bamboo), 6 % cashmere, 3 % polyamide
 Stitched filling: 550 g/m² comfort pad PU-foam
 Bottom fabric: 100 % polyamide
 washable at 60°C/140°F, not suitable for drier

Standard dimensions

| lengths cm | 190/200 | width cm | 80/90/95/100 | 120 | 140 | 70-100 | 101-120 | 121-140 | 141-160 | 161-200 |
|------------|---------|----------|--------------|-----|-----|--------|---------|---------|---------|---------|
|------------|---------|----------|--------------|-----|-----|--------|---------|---------|---------|---------|

Special lengths up to 200 cm at no extra cost. Extra cost for special lengths (with all widths) between 200 and 220 cm.

Curved mattresses at extra cost. Please specify the precise radius or send us pattern.

Special dimensions Please provide precise bed inside measurements

Jersey IS with climate border



A synthetic cover stitched with comfort pad foam, due to its washability (up to 60°C/140°F) also ideal for persons allergic to household dust and persons suffering from asthma. Here we use a fibre that distributes the moisture on the fibre surface and lets it evaporate very quickly. This property is maintained for a long time even after washing the material frequently. Accordingly, we have succeeded in giving the synthetic fibre a "natural feeling". The included carbon fibre has an antistatic and dust repelling effect.

Features:

4 robust turning handles, zipper all the way round, climate border

Overall height: approx. 20 cm

Cover fabric:

Outer material: 45 % polyamide, 35 % viscose (bamboo), 20 % polyester
 Stitched filling: 550 g/m² comfort pad PU-foam
 Bottom fabric: 100 % polyamide
 washable at 60°C/140°F, not suitable for drier

Standard dimensions

| lengths cm | 190/200 | width cm | 80/90/95/100 | 120 | 140 | 70-100 | 101-120 | 121-140 | 141-160 | 161-200 |
|------------|---------|----------|--------------|-----|-----|--------|---------|---------|---------|---------|
|------------|---------|----------|--------------|-----|-----|--------|---------|---------|---------|---------|

Special lengths up to 200 cm at no extra cost. Extra cost for special lengths (with all widths) between 200 and 220 cm.

Curved mattresses at extra cost. Please specify the precise radius or send us pattern.

Special dimensions Please provide precise bed inside measurements

Jersey CS with climate border



Cover material that is pleasant to touch thanks to top quality cashmere fibres. The material also includes carbon threads that have an anti-static and dust-repellent effect.

Features:

4 robust turning handles, zipper all the way round, climate border

Overall height: approx. 20 cm

Cover fabric:

Outer material: 56 % polyester, 35 % viscose (bamboo), 6 % cashmere, 3 % polyamide
 Stitched filling: 550 g/m² comfort pad PU-foam
 Bottom fabric: 100 % polyamide
 washable at 60°C/140°F, not suitable for drier

Standard dimensions

| lengths cm | 190/200 | width cm | 80/90/95/100 | 120 | 140 | 70-100 | 101-120 | 121-140 | 141-160 | 161-200 |
|------------|---------|----------|--------------|-----|-----|--------|---------|---------|---------|---------|
|------------|---------|----------|--------------|-----|-----|--------|---------|---------|---------|---------|

Special lengths up to 200 cm at no extra cost. Extra cost for special lengths (with all widths) between 200 and 220 cm.

Curved mattresses at extra cost. Please specify the precise radius or send us pattern.

Special dimensions Please provide precise bed inside measurements

Jersey CW with climate stripe



Cover material that is pleasant to touch thanks to top quality cashmere fibres. The material also includes carbon threads that have an anti-static and dust-repellent effect. The cover material is quilted with a luxuriant fleece filling. The climate-regulating wool fleece and silk fleece turn the CW cover into a special-category mattress cover.

Features:

4 robust turning handles, zipper all the way round, climate stripe

Overall height: approx. 20 cm

Cover fabric:

Outer material: 56 % polyester, 35 % viscose (bamboo), 6 % cashmere, 3 % polyamide
 Stitched fleece filling: 550 g/m² wool fleece (85 % new wool, 15 % polyester climate fibre) and 100 g/m² silk fleece (95 % silk, 5 % polyester climate fibre)
 Bottom fabric: 100 % cotton
 suitable for dry-cleaning

Standard dimensions

| lengths cm | 190/200 | width cm | 80/90/95/100 | 120 | 140 | 70-100 | 101-120 | 121-140 | 141-160 | 161-200 |
|------------|---------|----------|--------------|-----|-----|--------|---------|---------|---------|---------|
|------------|---------|----------|--------------|-----|-----|--------|---------|---------|---------|---------|

Special lengths up to 200 cm at no extra cost. Extra cost for special lengths (with all widths) between 200 and 220 cm.

Curved mattresses at extra cost. Please specify the precise radius or send us pattern.

Special dimensions Please provide precise bed inside measurements

Jersey CW with climate border



Cover material that is pleasant to touch thanks to top quality cashmere fibres. The material also includes carbon threads that have an anti-static and dust-repellent effect. The cover material is quilted with a luxuriant fleece filling. The climate-regulating wool fleece and silk fleece turn the CW cover into a special-category mattress cover.

Features:

4 robust turning handles, zipper all the way round, climate border

Overall height: approx. 20 cm

Cover fabric:

Outer material: 56 % polyester, 35 % viscose (bamboo), 6 % cashmere, 3 % polyamide
 Stitched fleece filling: 550 g/m² wool fleece (85 % new wool, 15 % polyester climate fibre) and 100 g/m² silk fleece (95 % silk, 5 % polyester climate fibre)
 Bottom fabric: 100 % cotton
 suitable for dry-cleaning

Standard dimensions

| lengths cm | 190/200 | width cm | 80/90/95/100 | 120 | 140 | 70-100 | 101-120 | 121-140 | 141-160 | 161-200 |
|------------|---------|----------|--------------|-----|-----|--------|---------|---------|---------|---------|
|------------|---------|----------|--------------|-----|-----|--------|---------|---------|---------|---------|

Special lengths up to 200 cm at no extra cost. Extra cost for special lengths (with all widths) between 200 and 220 cm.

Curved mattresses at extra cost. Please specify the precise radius or send us pattern.

Special dimensions Please provide precise bed inside measurements

Lattoflex Mattress TOP



The TOP mattress is geared to uncompromising comfort. The inside consists of a Lattoflex mattress core (approx. 17 cm) in the required design and hardness (Sensitive, Medium, Compact or Conform). The whole thing is rounded off by an integrated topper coat (approx. 9 cm). Both cores are bound together by an elaborate mattress cover. A comfort padding quilt foam and a quilt fleece are integrated under the top material. The material in turn creates the dot quilting with a fluffy effect. The integrated cashmere fibres give the material a good grip while the carbon threads have an anti-static and dust-repellent effect.

Features:

Separate pockets in the interior for mattress core and topper core. Two peripheral zip fasteners. Stitched border with 4 robust turning handles.

Overall height: approx. 29 cm

Cover fabric:

Outer material: 56 % polyester, 35 % viscose (bamboo), 6 % cashmere, 3 % polyamide
 Stitched fleece filling 850 g/m²:
 550 g/sm comfort padding PU foam and 300 g/m² quilt fleece (100 % polyester climate fibre)
 Bottom fabric: 100 % polyamide
 Border: 100 % polyester, quilted with 225 g/m² comfort padding PU foam
 Underside: 100 % polyester
 washable 40° C, not suitable for drier

Caution:

Pneumatic spring adjustment does not work perfectly in combination with spring base 270.
 Please enquire about combination with spring base 251 (bedding box opening).

Standard dimensions

| lengths cm | 190/200 | width cm | 80/90/95/100 | 120 | 140 | 70-100 | 101-120 | 121-140 | 141-160 |
|------------|---------|----------|--------------|-----|-----|--------|---------|---------|---------|
|------------|---------|----------|--------------|-----|-----|--------|---------|---------|---------|

Special lengths up to 200 cm at no extra cost. Extra cost for special lengths (with all widths) between 200 and 220 cm.

Special dimensions Please provide precise bed inside measurements

Lattoflex mattress 200



The mattress with integrated backbone: the complete Lattoflex bed system in one piece. The Sensiv, Medium or Compact mattress cores are combined with the Lattoflex 200 spring base and all packed in a cover. No matter what this mattress lies on, even simply on the floor, it always offers the full lying and sleeping comfort of a complete Lattoflex bed system. Take for example designer beds with flat bed sides. These often only leave just a few centimetres insertion depth for the spring base. The Lattoflex mattress 200 rules out the need for compromise, as it includes a complete Lattoflex spring base with all the advantages, and can even be used for minimum insertion depths. The AGR seal of approval confirms that this amazing mattress is back-friendly. Please note: the mattress needs a continuous side support surface of at least 8 cm in width.

Features:

- Spring base: Lattoflex 200
- Foam core: Lattoflex core (Sensiv/Medium/Compact)
- Cover: separate inner compartments for spring base and mattress core
- Top surface with IS fabric, quilted with comfort upholstery foam
- Two peripheral zip fasteners, quilted border with 4 robust handles

Overall height: approx. 27 cm

Overall weight: (e.g. 90 x 200 cm, Medium) approx. 28 kg

Cover fabric:

Top material: 45% polyamide, 35% viscose (bamboo), 20% polyester
 Quilted filling 550 g/m² comfort upholstery UP foam
 Bottom material: 100% polyamide
 Border: 100% polyester, quilted with 240 g/m² comfort upholstery PU foam
 Underneath: 100% polyester
 washable at 40°C, not suitable for tumble drying.

Note:

Installation set for inserting directly in standard wooden beds: page 29.

Installation sets for the Lattoflex mattress 200

These installation sets can be used to insert the mattress in standard wooden beds. The aluminium bars can be screwed to the sides of the bed or to the middle longitudinal frame in double beds. They are fixed to the cross frames in beds with this feature.

Installation set 200S is needed for a single bed, installation set 200M for a double bed.

Aluminium angled bars, leg size 8 x 8 cm, 3 mm thick
 Predrilled hole matrix, screws included in the scope of supply
 Length: nominal length less 7 cm
 Available for beds measuring 190, 200, 210 and 220 in length
 Please state required type with the order.

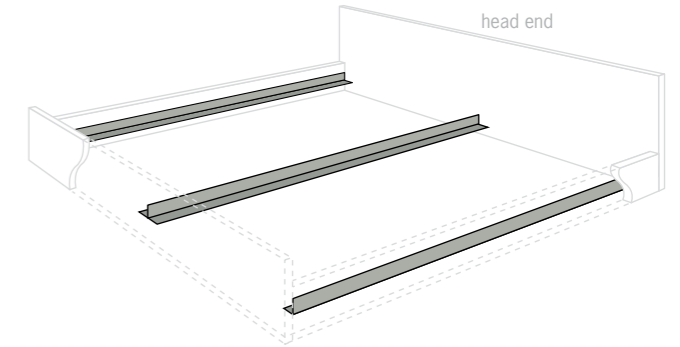

For all Lattoflex mattresses 200, for inserting directly in wooden beds.

- Installation set side support 200S:** 2 L-sections, screws and installation instructions
- Installation set middle support 200M:** 1 T-profile middle support, screws and installation instructions

Standard dimensions

| lengths cm | 190/200 | width cm | 80/90/95/100 | 120 | 140 | 70-100 | 101-120 | 121-140 |
|------------|---------|----------|--------------|-----|-----|--------|---------|---------|
|------------|---------|----------|--------------|-----|-----|--------|---------|---------|

Special lengths up to 200 cm at no extra cost. Extra cost for special lengths (with all widths) between 200 and 220 cm.

Special dimensions Please provide precise bed inside measurements

We guarantee our Lattoflex bed system 200

We give you a guarantee of 10 years on the elastic spring elements, the wing elements and the supporting profiles. In case a spring element is deformed, a wing element or supporting profile broken, we will quickly deliver parts for replacement.

This 10-year guarantee is also valid for the ClimaCell® core of your new Lattoflex mattress. Consider the mattress core as being as good as new for the first three years. On making any guarantee payments after this period of time, a value loss of 10% per year of use is deducted from the purchase price. Please accept that the statutory warranty period applies to the mattress covers.

The motors of motor-powered spring base systems are covered by a 3-year guarantee promise. A 3-year guarantee period also applies to all other material or manufacturing defects.

As a general rule, damage due to improper handling, misuse, subsequent modifications or natural wear and tear, are excluded from the warranty. Unfortunately, we will have to charge you for any installation and freight costs incurred after the legal warranty period has expired.

If you have any cause for complaint, please consult your Lattoflex dealer, keeping your invoice and/or this guarantee statement at the ready.

Your dealer will get in touch with us on your behalf so that we can restore your satisfaction as quickly as possible.

We have always manufactured Lattoflex products conscientiously with all due care and attention, making every effort not to pollute the environment. All materials have been chosen to ensure that they will not create an ecological problem at the end of their service life.

www.lattoflex.com

Thomas GmbH+Co. Sitz- und Liegemöbel KG · Postfach 1464 · 27424 Bremervörde · Germany
Tel. + 49 (0) 4761/979-0 · Fax + 49 (0) 4761/979-161 · E-Mail: info@lattoflex.com