

# Lattoflex 300



**„Lattoflex 300  
is gold for the  
back: the best  
spring base in  
the world!”**

**The backbone  
for your bed**

Only genuine  
with the gold seal!



Prof. Erich Schmitt MD  
Chairman of the Board of Forum Gesunder  
Rücken - besser leben e.V. (Forum Healthier  
Backs – For A Better Life)

Product information

**lattoflex®**

# Lattoflex 300 – the bed system for your enjoyment

Whether as a basic version or high-tech frame with comfort and convenience at the touch of a button, all models in the Lattoflex 300 series offer the unique wing spring system, the comfortable shoulder zone and the possibility of adjusting all the zones individually.

Together with a mattress by Lattoflex, which was specifically developed for these highly flexible spring bases, the Lattoflex bed system is turned into an oasis of peace and relaxation. Different mattress cores and a marvellous selection of covers will satisfy any customer's requests.

Please also note the great new possibilities to be found in this new brochure, such as remote control and the range of accessories (page 16).



- 1** Extra-sensitive initial spring deflection
- 2** Patented Lattoflex wing spring system  
Extra-long spring arms adapt to the shape of the body in a unique fashion for fantastic comfort.
- 3** Contour and weight adjustment:  
The oval double section can be turned to offer hitherto unsurpassed adaptation to different bodyweights and body contours.
- 4** The side spring element cushions the main weight in each zone.

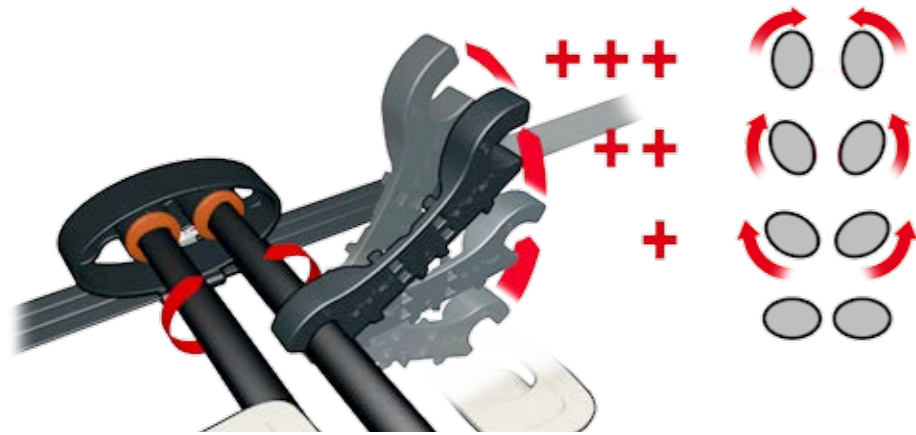

The double section is firmer when turned upright.

The double section is softer when turned flat.

Use the adjusting tool to find the required firmness which can be adjusted easily and precisely in four stages – to give the back support exactly where it is needed.



For all motor frames: new Lattoflex radio remote control with colour display to control all motor settings and other options. Furthermore, the motor frames can also be controlled by Smart-phone as an option (see page 16).

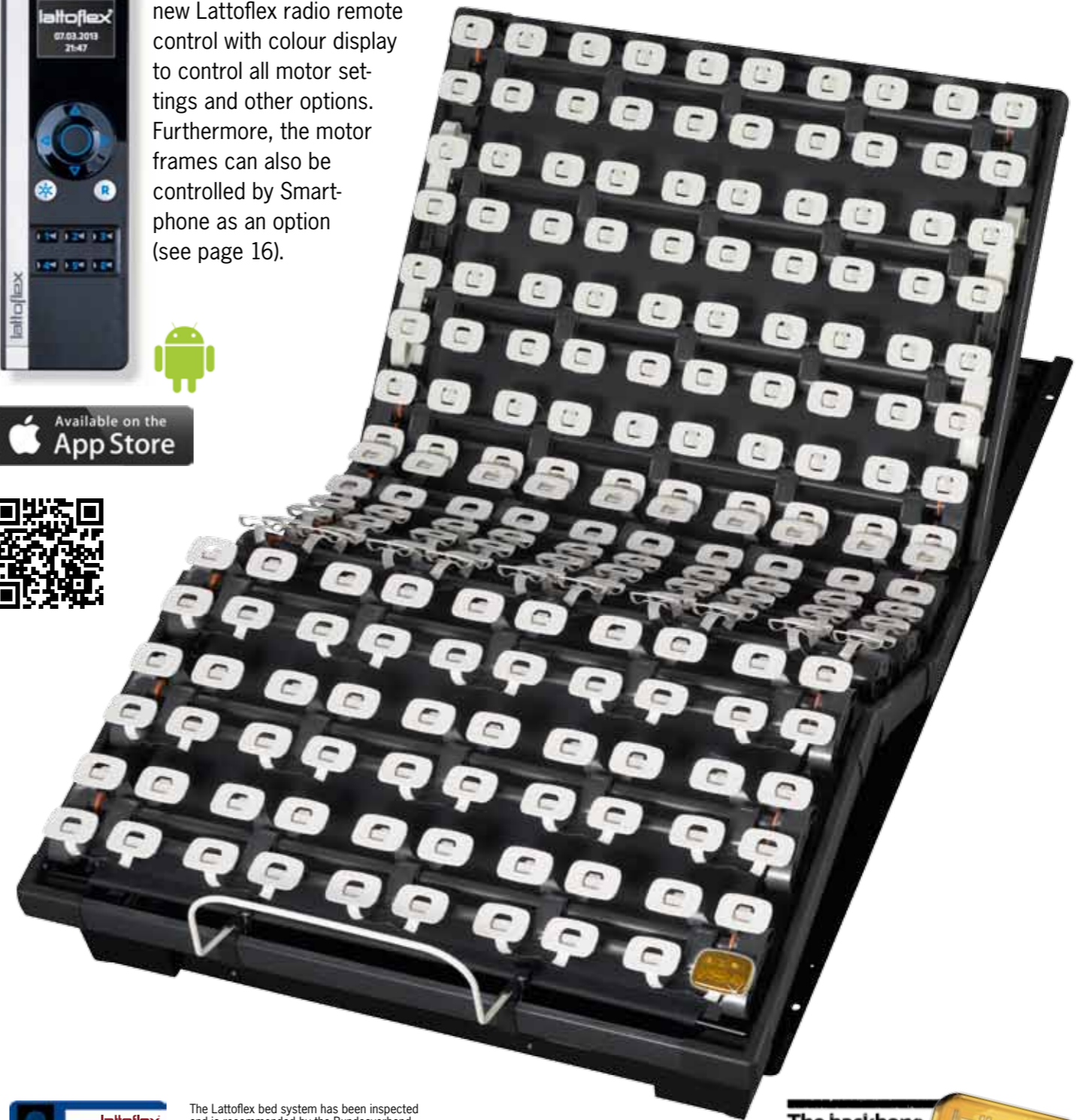

The Lattoflex bed system has been inspected and is recommended by the Bundesverband der deutschen Rückenschulen e.V. and the Forum Gesunder Rücken – besser leben e.V.  
For further information on the quality seal of AGR e.V., write to: P.O. Box 103 27443 Selsingen/Germany Internet: www.agr-ev.de



Only genuine with the gold seal!



Please turn to page 20 for the Lattoflex mattresses with all details.

# Lattoflex 300



Frame height: approx. 11 cm Frame width: nominal dimension minus approx. 1.1cm Frame length: nominal dimension minus approx. 3.0 cm 		
shoulder comfort zone 	Included in the scope of supplies: 2 FB spring blocks 4 FWB spring travel limiters 	

# Lattoflex 310



Frame height: approx. 11 cm Frame width: nominal dimension minus approx. 1.1cm Frame length: nominal dimension minus approx. 3.0 cm 		
head adjustment manual, 5-stage 	shoulder comfort zone 	Included in the scope of supplies: 2 FB spring blocks 4 FWB spring travel limiters 

# Lattoflex 320



Frame height: approx. 11.5 cm Frame width: nominal dimension minus approx. 1.1 cm Frame length: nominal dimension minus approx. 3.0 cm Longitudinal support strip: max. 4.0 cm 		
head adjustment manual, 5-stage 	shoulder comfort zone 	Reflux adjustment manual, 3-stage, approx. 2.5 cm, 7 cm, 11 cm 
Included in the scope of supplies: 2 FB spring blocks 4 FWB spring travel limiters 		

# Lattoflex 330



Frame height: approx. 11.5 cm Frame width: nominal dimension minus approx. 1.1 cm Frame length: nominal dimension minus approx. 3.0 cm Longitudinal support strip: max. 4.0 cm 		
head adjustment manual, 5-stage 	shoulder comfort zone 	body inclination positioning manual, 3-stage, approx. 2.5 cm, 7 cm, 11 cm 
Included in the scope of supplies: 2 FB spring blocks 4 FWB spring travel limiters 		

## Standard dimensions

length cm	190/200	width cm	80/90/95/100	120	140
-----------	---------	----------	--------------	-----	-----

## Special dimensions

Please provide precise bed inside measurements

length cm	190/200	width cm	70-100	101-120	121-140
-----------	---------	----------	--------	---------	---------

Extra cost for special lengths between 190 and 220 cm

Accessories at a surcharge see pages 17 - 19

Please note the instructions on page 7.

## Standard dimensions

length cm	190/200	width cm	80/90/95/100	120	140
-----------	---------	----------	--------------	-----	-----

## Special dimensions

Please provide precise bed inside measurements

length cm	190/200	width cm	70-100	101-120	121-140
-----------	---------	----------	--------	---------	---------

Extra cost for special lengths between 190 and 220 cm

Accessories at a surcharge see pages 17 - 19

Please note the instructions on page 7.

## Standard dimensions

length cm	190/200	width cm	80/90/95/100	120	140
-----------	---------	----------	--------------	-----	-----

## Special dimensions

Please provide precise bed inside measurements

length cm	190/200	width cm	70-100	101-120	121-140
-----------	---------	----------	--------	---------	---------

Extra cost for special lengths between 190 and 220 cm

Accessories at a surcharge see pages 17 - 19

Please note the instructions on page 7.

## Standard dimensions

length cm	190/200	width cm	80/90/95/100	120	140
-----------	---------	----------	--------------	-----	-----

## Special dimensions

Please provide precise bed inside measurements

length cm	190/200	width cm	70-100	101-120	121-140
-----------	---------	----------	--------	---------	---------

Extra cost for special lengths between 190 and 220 cm

Accessories at a surcharge see pages 17 - 19

Please note the instructions on page 7.

# All sitting frames at a glance

Model	head adjustment	shoulder comfort zone, adjustable	body inclination positioning	back adjustment	seat and knee joint adjustment, infinitely variable (parallel, pneumatic spring)	thigh adjustment	lower leg adjustment	infrared remote control unit emergency lowering
<b>Lattoflex 350</b> <b>Lattoflex 351:</b> with bedding box opening	X	X		X manual, 6-stage				
<b>Lattoflex 360</b>	X	X		X manual, 6-stage		knee adjustment		
<b>Lattoflex 370</b>	X	X			X			
<b>Motorised frames</b>								
<b>Lattoflex 395</b>	X motorised	X	X motorised	X motorised		X motorised	X motorised	X
<b>Lattoflex 394-KS</b>	X motorised	X	X motorised	X motorised		X motorised		X
<b>Lattoflex 394-KU</b>	X motorised	X		X motorised		X motorised	X motorised	X
<b>Lattoflex 394-US</b>	X	X	X motorised	X motorised		X motorised	X motorised	X
<b>Lattoflex 393-K</b>	X motorised	X		X motorised		X motorised		X
<b>Lattoflex 393-U</b>	X	X		X motorised		X motorised	X motorised	X
<b>Lattoflex 393-S</b>	X	X	X motorised	X motorised		X motorised		X
<b>Lattoflex 392</b>	X	X		X motorised		X motorised		X

## Please note for Lattoflex 370:

### Draw belt on the left or right?

Please specify when placing your order. Standard installation is on the left (looking from the foot-end) for your right hand. Especially important for double beds or for beds placed lengthwise against the wall.

### Installation dimensions

The pneumatic spring frame lowers slightly in the sitting position. In beds with longitudinal supporting beams, the supporting beam in the middle has to be removed, starting approx. 70 cm from the

head end over a length of 65 cm. If in any doubt, please contact our internal sales staff. The pneumatic spring mechanism needs an installation depth of approx. 17 cm.

### Handling

The pneumatic spring makes it easier to adjust the sitting position and the knee-joint setting. However, the adjustment must always be carried out by the user shifting his/her weight. In other words, please always test this with the customer and the required mattress

## Installation solutions / placing in a bed system

In designing our frames, we make sure that they are extensively compatible with the various models of bed systems available on the market. Basically, longitudinal supporting beams on the side are not a problem up to a width of 4 cm; the same also applies to triangular supports with leg lengths of up to 15 cm. When placing in a bed, we recommend an insertion depth of at least 15 to 17 cm so that the bed frame supports and holds the mattress adequately.

If necessary, please refer to the following table so that any necessary installation sets can be ordered at the same time. We give the installation recommendations for each frame type and indicate possible installation sets. Please do not hesitate to contact us in person if you have questions, or you can also contact our internal sales staff if in any doubt.

Bed type	Lateral longitudinal supporting beams	Middle supporting beams/longitudinal frame in double beds	Triangular supports	Cross-frame beds	Beds with bedding box
<b>Lattoflex 300</b>	no restrictions	no restrictions	no restrictions	no restrictions	no restrictions
<b>Lattoflex 310</b>	no restrictions	no restrictions	no restrictions	no restrictions	no restrictions
<b>Lattoflex 320</b>	max. 4 cm	max. 8 cm	max leg length 15 cm	modify the bed frame, e.g. with triangular supports	a bedding box protruding max. 4 cm inside the bed is no problem. Otherwise remove the bedding box and modify e.g. with triangular supports
<b>Lattoflex 330</b>	max. 4 cm	max. 8 cm	max leg length 15 cm		
<b>Lattoflex 350</b>	max. 4 cm	max. 8 cm	max leg length 15 cm Extension elements are needed, see page 17.	beds with cross-frames are not suitable for these frame types. Depending on bed frame suitability, check possible use of the following installation sets: <b>stand-alone with bed side connection</b> (see page 18)	a bedding box protruding max. 4 cm inside the bed is no problem. Otherwise remove the bedding box. Depending on bed frame suitability, check possible use of the following installation sets: <b>stand-alone with bed side connection</b> (see page 18)
<b>Lattoflex 351</b>	max. 4 cm	max. 8 cm			
<b>Lattoflex 360</b>	max. 4 cm	max. 8 cm			
<b>Lattoflex 370</b>	max. 4 cm, must be removed in the middle (see instructions above), possibly check use of <b>suspended bracket</b> , page 18	max. 8 cm, must be removed in the middle (see instructions above). See also page 18: <b>special installation set 370</b>			
<b>Lattoflex 39x</b>	max. 4 cm	max. 8 cm			

# Lattoflex 350



# Lattoflex 351



# Lattoflex 360

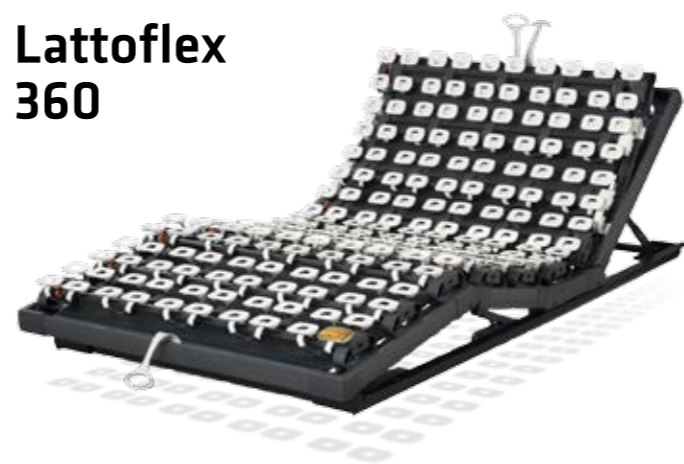

# Lattoflex 370

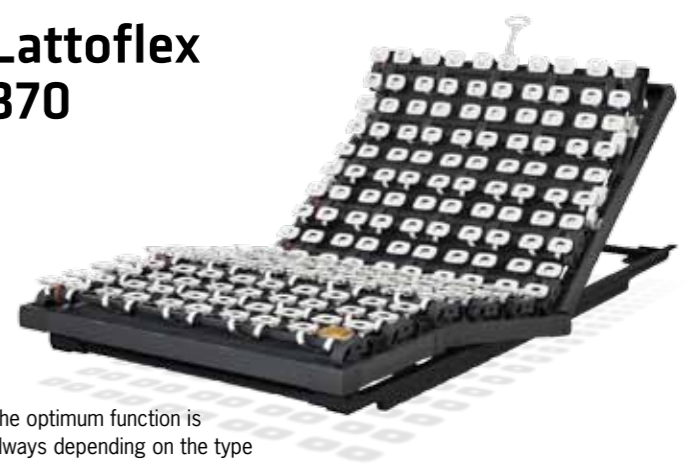

The optimum function is always depending on the type of mattress and the weight of the user. Therefore: **Always test with the customer.**

Frame height: approx. 11.5 cm  
 Frame width: nominal dimension minus approx. 1.1 cm  
 Frame length: nominal dimension minus approx. 3.0 cm  
 Longitudinal support strip: max. 4.0 cm

11,5 cm = manually adjustable, nobody should be in bed during adjustment!

head adjustment manual, 5-stage	shoulder comfort zone	upper part of the body adjustment, manual, 6-stage (max. approx. 40°) approx. 13 - 47 cm
To optimize the sitting position: Foot adjustment, 3-stage, approx. 2.5 cm, 7 cm, 11 cm	Included in the scope of supplies: 2 FB spring blocks 4 FWB spring travel limiters	

Frame height: approx. 11.5 cm  
 Frame width: nominal dimension minus approx. 1.1 cm  
 Frame length: nominal dimension minus approx. 3.0 cm  
 Longitudinal support strip: max. 4.0 cm

11,5 cm = manually adjustable, nobody should be in bed during adjustment!

head adjustment manual, 5-stage	shoulder comfort zone	upper part of the body adjustment, manual, 6-stage (max. approx. 40°) approx. 13 - 47 cm
To optimize the sitting position: Foot adjustment, 3-stage, approx. 2.5 cm, 7 cm, 11 cm	bedding box opening with pneumatic springs opening angle 30° (approx. 80 cm)	Included in the scope of supplies: 2 FB spring blocks 4 FWB spring travel limiters

Frame height: approx. 11.5 cm  
 Frame width: nominal dimension minus approx. 1.1 cm  
 Frame length: nominal dimension minus approx. 3.0 cm  
 Longitudinal support strip: max. 4.0 cm

11,5 cm = manually adjustable, nobody should be in bed during adjustment!

head adjustment manual, 5-stage	shoulder comfort zone	upper part of the body adjustment, manual, 6-stage (max. approx. 40°) approx. 13 - 47 cm
knee adjustment manual, 3-stage approx. 2.5 cm, 7.5 cm, 12.5 cm	Lower leg lifting, manual, 3-stage, as addendum to knee adjustment	Included in the scope of supplies: 2 FB spring blocks 4 FWB spring travel limiters

Frame height: approx. 11.5 cm  
 Frame width: nominal dimension minus approx. 1.1 cm  
 Frame length: nominal dimension minus approx. 3.0 cm  
 Inlay depth approx. 17 cm  
 Highest setting angle for upper part of the body adjustment: approx. 50°

11,5 cm 17,0 cm = adjustable by shifting of weight

head adjustment manual, 5-stage	shoulder comfort zone	seat and knee joint adjustment infinitely variable (parallel, pneumatic spring)
Included in the scope of supplies: 2 FB spring blocks 4 FWB spring travel limiters		

## Standard dimensions

length cm	190/200	width cm	80/90/95/100	120	140
-----------	---------	----------	--------------	-----	-----

## Standard dimensions

length cm	200	width cm	80/90/95/100	120	140
-----------	-----	----------	--------------	-----	-----

## Standard dimensions

length cm	190/200	width cm	80/90/95/100	120	140
-----------	---------	----------	--------------	-----	-----

## Standard dimensions

length cm	190/200	width cm	80/90/95/100	120	140
-----------	---------	----------	--------------	-----	-----

## Special dimensions

Please provide precise bed inside measurements

length cm	190/200	width cm	70-100	101-120	121-140
-----------	---------	----------	--------	---------	---------

Extra cost for special lengths between 190 and 220 cm

## Special dimensions

Please provide precise bed inside measurements

length cm	200	width cm	70-100	101-120	121-140
-----------	-----	----------	--------	---------	---------

Extra cost for special lengths between 200 and 220 cm

## Special dimensions

Please provide precise bed inside measurements

length cm	190/200	width cm	70-100	101-120	121-140
-----------	---------	----------	--------	---------	---------

Extra cost for special lengths between 190 and 220 cm

## Special dimensions

Please provide precise bed inside measurements

length cm	190/200	width cm	70-100	101-120	121-140
-----------	---------	----------	--------	---------	---------

Extra cost for special lengths between 190 and 220 cm

**Accessories at a surcharge**  
see pages 17 - 19

Please note the instructions on page 7.

**Accessories at a surcharge**  
see pages 17 - 19

Please note the instructions on page 7.

**Accessories at a surcharge**  
see pages 17 - 19

Please note the instructions on page 7.

**Accessories at a surcharge**  
see pages 17 - 19

Please note the instructions on page 7.

# Motor frames

Please note the instructions on page 15!

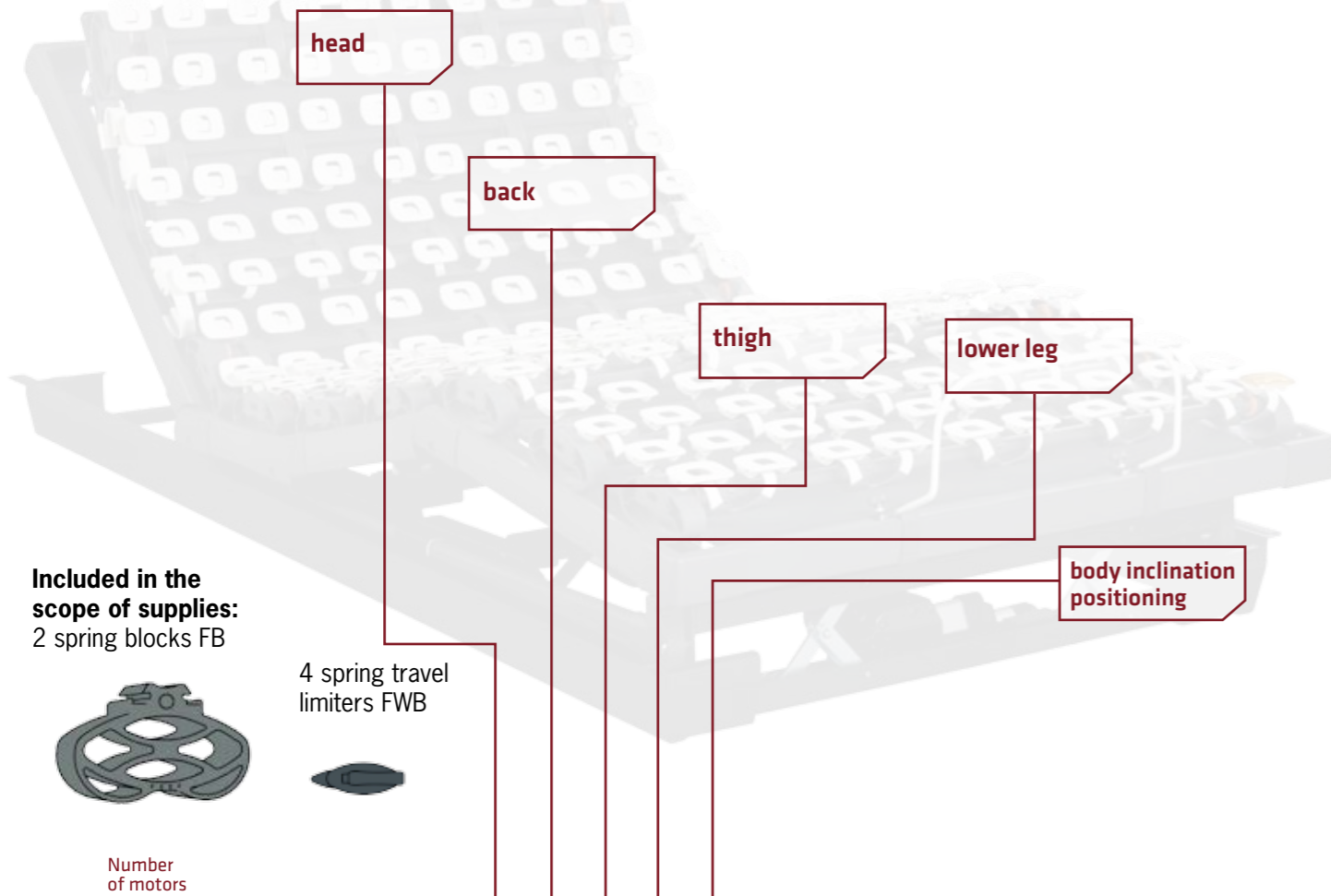

Included in the scope of supplies:  
2 spring blocks FB

4 spring travel limiters FWB

Number of motors

Number of motors	Model	Head	Back	Thigh	Lower leg	Body inclination
2	Lattoflex 392	Hand	M	M		
3	Lattoflex 393-U	Hand	M	M	M	
3	Lattoflex 393-S	Hand	M	M		M
3	Lattoflex 393-K		M	M	M	
4	Lattoflex 394-US	Hand	M	M	M	M
4	Lattoflex 394-KS		M	M	M	M
4	Lattoflex 394-KU		M	M	M	M
5	Lattoflex 395		M	M	M	M

Hand icon: manual head adjustment

M icon: motorised function



All Lattoflex 300 motor frames are equipped with the new intelligent radio remote control as a standard feature. The radio connection between motor frame and remote control on both sides offers new possibilities. The remote control only shows those motors and options that are actually fitted to the motor frame, without any empty displays or empty buttons. It shows the exact position of all adjustable parts at any time.

Other features:

- Reliable radio connection, visual contact between transmitter and receiver is not necessary
- 6 memory buttons for quick access to the favourite positions
- The buttons light up when the remote control is moved
- Integrated torch function
- Control prepared for further options (see page 16)
- Storage pocket in felt look (see page 16)

As an option, the motor frames can be controlled by Smartphone using the Lattoflex app, see accessories, page 16.



The Lattoflex bed system has been inspected and is recommended by the Bundesverband der deutschen Rückenschulen e.V. and the Forum Gesunder Rücken – besser leben e.V. For further information on the quality seal of AGR e.V., write to: P.O. Box 103 27443 Selsingen/Germany Internet: www.agr-ev.de

## Lattoflex 395



## Lattoflex 394-KS



Frame height: approx. 11.5 cm  
Frame width: nominal dimension minus approx. 1.1 cm  
Frame length: nominal dimension minus approx. 3.0 cm  
Inlay depth: approx. 13 cm

infinitely variable head adjustment motorised	shoulder comfort zone	back adjustment motorised (max. approx. 50°)
thigh adjustment motorised	lower leg adjustment motorised	infinitely variable body inclination positioning, motorised
remote control unit with 6 memory functions	emergency lowering device in case of loss of electricity (battery)	mattress holder at foot-end

### Standard dimensions

length cm	190/200	width cm	80/90/95/100	120	140
-----------	---------	----------	--------------	-----	-----

### Special dimensions

Please provide precise bed inside measurements

length cm	190/200	width cm	75-100	101-120	121-140
-----------	---------	----------	--------	---------	---------

Extra cost for special lengths between 190 and 220 cm  
**3-year motor warranty**

Hand icon: manually adjustable  
Arrow icon: motorised adjustable

Accessories at a surcharge  
see pages 16 - 19

Please note the instructions on page 7 and 15.

Frame height: approx. 11.5 cm  
Frame width: nominal dimension minus approx. 1.1 cm  
Frame length: nominal dimension minus approx. 3.0 cm  
Inlay depth: approx. 13 cm

infinitely variable head adjustment motorised	shoulder comfort zone	back adjustment motorised (max. approx. 50°)
thigh adjustment motorised	infinitely variable body inclination positioning, motorised	remote control unit with 6 memory functions
emergency lowering device in case of loss of electricity (battery)	mattress holder at foot-end	

### Standard dimensions

length cm	190/200	width cm	80/90/95/100	120	140
-----------	---------	----------	--------------	-----	-----

### Special dimensions

Please provide precise bed inside measurements

length cm	190/200	width cm	75-100	101-120	121-140
-----------	---------	----------	--------	---------	---------

Extra cost for special lengths between 190 and 220 cm  
**3-year motor warranty**

Hand icon: manually adjustable  
Arrow icon: motorised adjustable

Accessories at a surcharge  
see pages 16 - 19

Please note the instructions on page 7 and 15.

# Lattoflex 394-KU



Frame height: approx. 11.5 cm  
 Frame width: nominal dimension minus approx. 1.1 cm  
 Frame length: nominal dimension minus approx. 3.0 cm  
 Inlay depth: approx. 13 cm

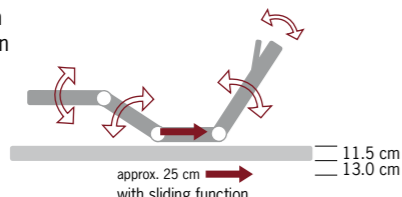

infinitely variable head adjustment motorised	shoulder comfort zone	back adjustment motorised (max. approx. 50°)
thigh adjustment motorised	lower leg adjustment motorised	remote control unit with 6 memory functions
emergency lowering device in case of loss of electricity (battery)	mattress holder at foot-end	

## Standard dimensions

length cm	190/200	width cm	80/90/95/100	120	140
-----------	---------	----------	--------------	-----	-----

## Special dimensions

Please provide precise bed inside measurements

length cm	190/200	width cm	75-100	101-120	121-140
-----------	---------	----------	--------	---------	---------

Extra cost for special lengths between 190 and 220 cm  
**3-year motor warranty**



**Accessories at a surcharge**  
 see pages 16 - 19

Please note the instructions on page 7 and 15.

# Lattoflex 394-US



Frame height: approx. 11.5 cm  
 Frame width: nominal dimension minus approx. 1.1 cm  
 Frame length: nominal dimension minus approx. 3.0 cm  
 Inlay depth: approx. 13 cm

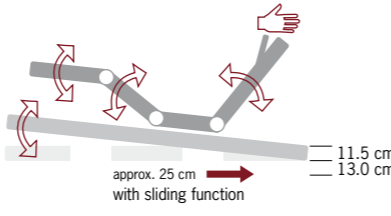

head adjustment manual, 5-stage	shoulder comfort zone	back adjustment motorised (max. approx. 50°)
thigh adjustment motorised	lower leg adjustment motorised	infinitely variable body inclination positioning, motorised
remote control unit with 6 memory functions	emergency lowering device in case of loss of electricity (battery)	mattress holder at foot-end

## Standard dimensions

length cm	190/200	width cm	80/90/95/100	120	140
-----------	---------	----------	--------------	-----	-----

## Special dimensions

Please provide precise bed inside measurements

length cm	190/200	width cm	75-100	101-120	121-140
-----------	---------	----------	--------	---------	---------

Extra cost for special lengths between 190 and 220 cm  
**3-year motor warranty**



**Accessories at a surcharge**  
 see pages 16 - 19

Please note the instructions on page 7 and 15.

# Lattoflex 393-K



Frame height: approx. 11.5 cm  
 Frame width: nominal dimension minus approx. 1.1 cm  
 Frame length: nominal dimension minus approx. 3.0 cm  
 Inlay depth: approx. 13 cm

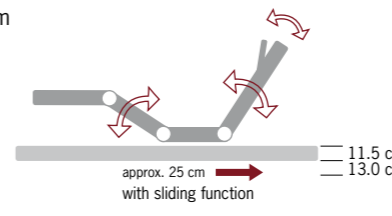

infinitely variable head adjustment motorised	shoulder comfort zone	back adjustment motorised (max. approx. 50°)
thigh adjustment motorised	remote control unit with 6 memory functions	emergency lowering device in case of loss of electricity (battery)
mattress holder at foot-end		

## Standard dimensions

length cm	190/200	width cm	80/90/95/100	120	140
-----------	---------	----------	--------------	-----	-----

## Special dimensions

Please provide precise bed inside measurements

length cm	190/200	width cm	75-100	101-120	121-140
-----------	---------	----------	--------	---------	---------

Extra cost for special lengths between 190 and 220 cm  
**3-year motor warranty**



**Accessories at a surcharge**  
 see pages 16 - 19

Please note the instructions on page 7 and 15.

# Lattoflex 393-U



Frame height: approx. 11.5 cm  
 Frame width: nominal dimension minus approx. 1.1 cm  
 Frame length: nominal dimension minus approx. 3.0 cm  
 Inlay depth: approx. 13 cm

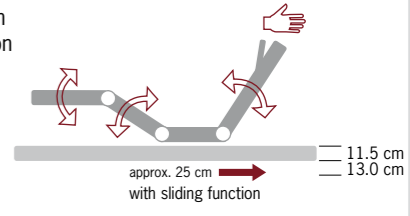

head adjustment manual, 5-stage	shoulder comfort zone	back adjustment motorised (max. approx. 50°)
thigh adjustment motorised	lower leg adjustment motorised	remote control unit with 6 memory functions
emergency lowering device in case of loss of electricity (battery)	mattress holder at foot-end	

## Standard dimensions

length cm	190/200	width cm	80/90/95/100	120	140
-----------	---------	----------	--------------	-----	-----

## Special dimensions

Please provide precise bed inside measurements

length cm	190/200	width cm	75-100	101-120	121-140
-----------	---------	----------	--------	---------	---------

Extra cost for special lengths between 190 and 220 cm  
**3-year motor warranty**



**Accessories at a surcharge**  
 see pages 16 - 19

Please note the instructions on page 7 and 15.

# Lattoflex 393-S



Frame height: approx. 11.5 cm  
 Frame width: nominal dimension minus approx. 1.1 cm  
 Frame length: nominal dimension minus approx. 3.0 cm  
 Inlay depth: approx. 13 cm

head adjustment manual, 5-stage	shoulder comfort zone	back adjustment motorised (max. approx. 50°)
thigh adjustment motorised	infinitely variable body inclination positioning, motorised	remote control unit with 6 memory functions
emergency lowering device in case of loss of electricity (battery)	mattress holder at foot-end	

## Standard dimensions

length cm	190/200	width cm	80/90/95/100	120	140
-----------	---------	----------	--------------	-----	-----

## Special dimensions

Please provide precise bed inside measurements

length cm	190/200	width cm	75-100	101-120	121-140
-----------	---------	----------	--------	---------	---------

Extra cost for special lengths between 190 and 220 cm  
**3-year motor warranty**



**Accessories at a surcharge**  
 see pages 16 - 19

Please note the instructions on page 7 and 15.

# Lattoflex 392



**Optional:**  
 Simple button switch for Lattoflex 392 (without surcharge). Please state with order.

Frame height: approx. 11.5 cm  
 Frame width: nominal dimension minus approx. 1.1 cm  
 Frame length: nominal dimension minus approx. 3.0 cm  
 Inlay depth: approx. 13 cm

head adjustment manual, 5-stage	shoulder comfort zone	back adjustment motorised (max. approx. 50°)
thigh adjustment motorised	remote control unit with 6 memory functions	<b>Optional for Lattoflex 392:</b> Simple button switch with restricted functions (no memory function, control of accessories is not possible).
emergency lowering device in case of loss of electricity (battery)	mattress holder at foot-end	

## Standard dimensions

length cm	190/200	width cm	80/90/95/100	120	140
-----------	---------	----------	--------------	-----	-----

## Special dimensions

Please provide precise bed inside measurements

length cm	190/200	width cm	75-100	101-120	121-140
-----------	---------	----------	--------	---------	---------

Extra cost for special lengths between 190 and 220 cm  
**3-year motor warranty**



**Accessories at a surcharge**  
 see pages 16 - 19

Please note the instructions on page 7 and 15.

## Please note for all motor frames:

At the head-end, the frame needs a clear height of approx. 70 cm plus the mattress height, measured from the supporting point of the longitudinal beam. This is important, e.g., with inclined roofs or shelves.

Installation depth of approx. 13 cm in the substructure is required for the adjustment mechanism and for the drive system.

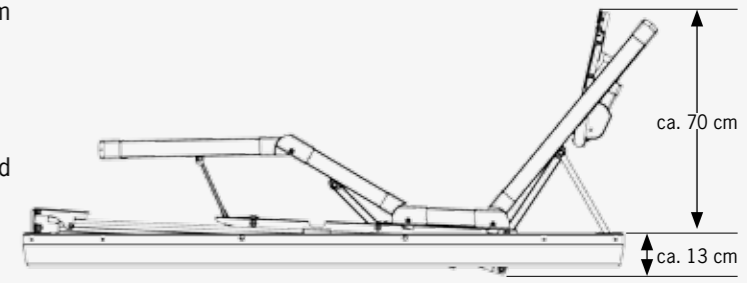

## Please take account of the following details when advising your customer:

- Please point out to your customer that the use of one frame (e.g. 140 cm width) by two persons will not be suitable for their backs!
- For installation in beds, we need to know the clear inside measurements of the bed (important for special dimensions). We will then calculate the corresponding frame size.
- Ideal adjustment to the user's body and perfect functioning of all adjustment parts is only achieved when using a Lattoflex mattress.
- The motor frames are designed for longitudinal supporting beams of max. 4 cm (longitudinal middle beams for double beds: max. 8 cm).
- Triangular supports should have a leg length of 15 cm. If in any doubt, please contact our internal sales staff.
- Advise your customers to purchase fitted/fixe sheets for sitting frames.
- Upon delivery, please advise your customer to read the operating instructions and to keep them in a safe place.

## Contour and weight adjustment

Every Lattoflex 300 spring base is equipped with the highly effective contour and weight adjustment feature. A simple turn is all it takes to adjust every support profile in four stages (apart from the shoulder zone). On delivery, all support profiles are adjusted to the flat position (soft).

Adjusting without load: we recommend that you use the supplied adjusting tool, and that you hold the double section firmly with your second hand.

**Please note the turning direction: always turn from the outside to the inside, as shown in the drawing.**

You can hear the stages engage. To return to the flat position, continue turning the support profile in the same direction.

Each of the two support profiles in each double section can be set differently for fine adjustment to the body contour.

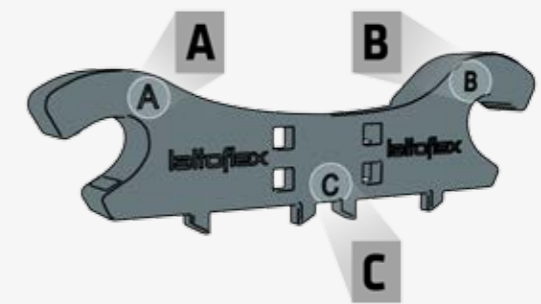

**Tool legend:**  
**A** for frame-width 80 to 100 cm  
**B** for frame-width 120 to 140 cm  
**C** for replacing the spring elements



# Accessories for motor frames at a surcharge

## Electrical hot water bottle

Used directly on the mattress. Connected to the motor frame and controlled with the Lattoflex remote control. This makes it easy to adjust the heating time (up to max. 60 min) and heating intensity, which can also be saved as favourite settings. One electrical hot water bottle can be connected to each motor frame.

Output: 50 watt / cable length approx. 3.20 m  
 Safe low voltage: 24V  
 Core of Lattoflex Evopor foam with tricot fabric, approx. 2.5 cm high.  
 The cover is made of highly permeable spacer fabric and can be removed and washed.  
 (Fabric: 63% polyester, 20% polypropylene, 17% viscose)



## LED underbed lighting

Dimmable light strip with 6 individual LEDs. Provides subdued guidance light. Connected to the motor frame and controlled with the Lattoflex remote control. This makes it easy to adjust the timer function and luminosity, which can also be saved as favourite settings. We recommend fitting the light strip under the bed or under the side of the bed. Including installation materials for screwing and adhering.

Cable length; approx. 2.0 m  
 Output: 1.65 watt  
 Dimensions: 16 cm / 2 cm / 1.2 cm (l x w x h)



## Pocket for the remote control

The pocket in black felt look can be wrapped around the side of the bed. With elastic gusset to fit circumferences of up to approx. 58 cm. The pocket is sewn in such a way that it is always slightly open to make it easy to insert the Lattoflex remote control. For safe, easily accessible storage of your Lattoflex remote control.  
 Black, 100% polyester, washable  
**One pocket is included with every motor frame as a standard feature.**

## Socket receiver

Up to 6 socket receivers can be controlled separately by each remote control. For consumers with up to 460 watt output. Safety fuse accessible from the outside. Can only be controlled by the new Lattoflex remote control (from model year 2013). A motor frame is not necessary for the socket receiver to work.

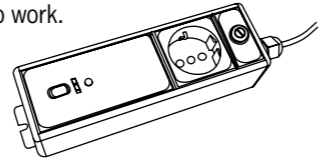

## Smart Remote

The Smart Remote connects your network (LAN or Wi-Fi) to the Lattoflex motor frame. Use the Lattoflex app (on the right) to control all the functions of your motor frame from many Smartphones or tablet PCs, as long as you are within your network range. The Smart Remote needs a power connection and a network cable (LAN cable) for connection to your Wi-Fi. Several motor frames can be controlled individually by one Smart Remote.

Range (maximum distance from the motor frame): 10 m

## Lattoflex App

This program gives you easy control of your motor frame from your iPhone, iPad or android device. Together with a compatible Smartphone or tablet, it requires a stable Wi-Fi network and the Smart Remote adapter (on the left). For details about the app, please refer to the corresponding provider pages. Search for the Lattoflex app or simply follow the QR code which contains the direct link:



free of charge

# Accessories for all frames at a surcharge

## Spring blocks FB / Spring travel limiters FWB

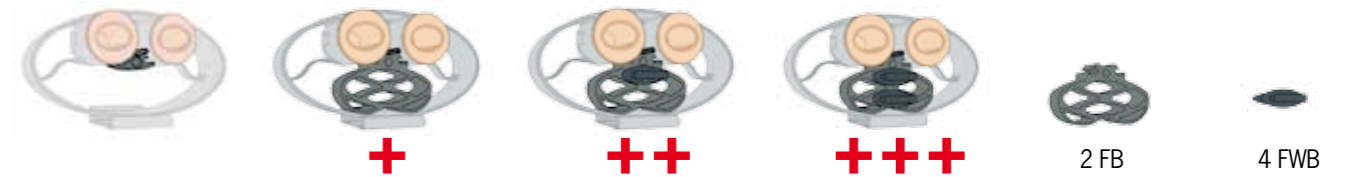

Use the spring blocks (FB) to adjust the Lattoflex spring base to your customer's individual needs, e.g. to relieve a hollow back. In addition, the spring travel limiters (FWB) can be inserted (or removed later) for fine tuning. 2 FBs and 4 FWBs are included with every spring base as a standard feature.

1 set consists of 2 FBs and 4 FWBs

## Mattress holders

Mattress holders prevent the mattress from slipping on bed frames that don't offer sufficient depth to hold the mattress properly. For sitting frames, one mattress holder at the foot end already prevents the mattress from slipping lengthwise. Can be retrofitted. All motor frames are supplied with one mattress holder as a standard feature.

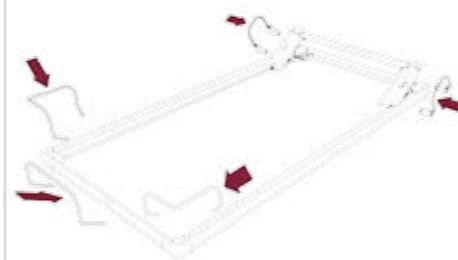

### MH foot

For mounting to cross bars at the foot end of all frame types (can also be fitted to the head end if necessary). All motor frames are supplied with one mattress holder as a standard feature.



Suitable for all spring base types.

Metal, creamy white, 1 pc.

### MH corner foot

For mounting across the corner, only at the foot end. Gives the mattress lengthwise and crosswise hold at the foot end. Can be used instead of MH foot.



For all spring base types, from Lattoflex 360 only from lengths of 200 cm.

Metal, creamy white, 1 set contains 2 pcs.

### MH side head

For mounting to the side at the head end.



For all spring base types from Lattoflex 310.

Metal, creamy white, 1 set contains 2 pcs.

## Extension elements

Needed for beds with triangular supports (leg length max. 15 cm).

Only for spring base types from Lattoflex 350 in beds with triangular supports

## Adjustment foot VF

Support foot to vary the height for many possible applications. One VF foot is already included in the installation set for longitudinal frames.

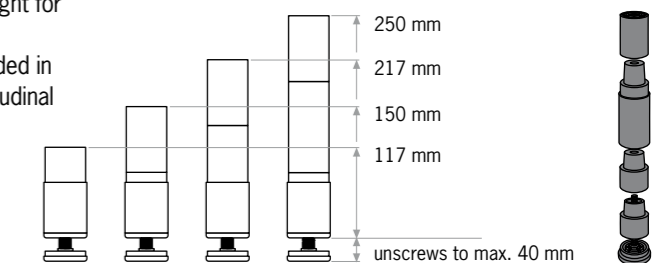

## Stand Alone

All spring bases can be put on their own feet as a stand-alone solution. For all frames from type 350 to 395, the required foot solution is simply screwed to the existing metal base. For types 300 to 330 there is a metal sub-frame with round feet.

All foot variations shown here give a sitting height of approx. 58 cm from the floor to the upper edge of the Lattoflex mattress.

Feet Q and R are available in special heights on request.

Equipped in this way, every spring base can be used as a stand-alone solution. As an option, an existing bed body can be attached to the Lattoflex spring base from types 350 using the accessory set „bed side connection“ (below).

Frame type	Scope of delivery	Feet R	Feet Q	Skids K
300	Sub-frame with round feet (foot height = 25 cm)	•	-	-
310				
320				
350	Foot solution (foot height = 22.5 cm)	•	•	•
351				
360				
370	Foot solution (foot height = 17.5 cm)	•	•	•
<b>Motor frame 392 - 395</b>				

## Fitted undersheet

The Lattoflex fitted undersheet is inserted between the base frame and the spring base. It acts as an elegant anthracite cover for all functional parts, e.g. rods and drive systems for motor frames,

while drawing attention to the spring base itself. Recommended especially for shop presentation.



without fitted undersheet



with fitted undersheet

Standard fitted undersheet available for all spring base types with dimensions 90/200 and 100/200. All other widths and special lengths on request.

## Suspended bracket

Use this set to prepare bed frames that don't have the necessary fittings so that they can take the Lattoflex spring base. The base plates (14 cm high) are screwed into the bed frame and the brackets suspended at the required height. 3 height settings: 0 – 24 mm – 48 mm – 72 mm

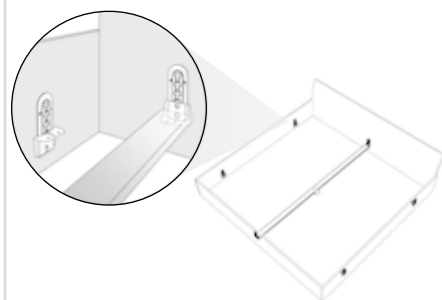

1 set contains 4 pcs.

## Longitudinal frame installation set

For double beds without middle beam. Consisting of 1 longitudinal frame (70 mm wide), 2 suspended brackets, 1 adjustable foot VF and screws. The suspended brackets make it possible to adjust the height of the longitudinal frame.

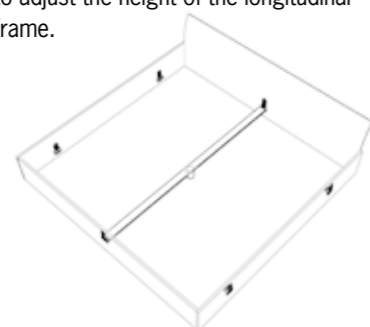

Lengths 190/200/210/220 cm

## Special longitudinal frame installation set for frame 370

Here the longitudinal support is interrupted so that frame 370 can be lowered in the middle. Consisting of 2 frame sections, 2 suspended brackets, 2 adjustable feet VF and screws.

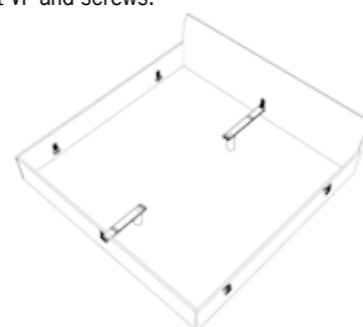

## Bed side connection

These adapters make it possible to fit an existing wooden bed frame to the Lattoflex spring base without needing a foot solution.

**Can be used for all frames from type 350 with „stand-alone“ foot solution.**

1 set contains 4 adapters for bed side connection

For double beds, the bed connection also has to be fitted. This holds the two beds together in position.

1 set contains 2 bed connectors

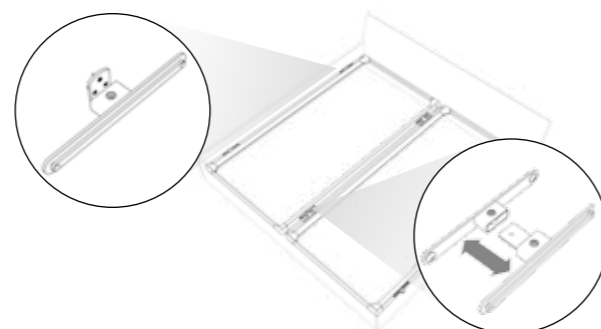

## Spare parts for Lattoflex 300 frames

for frames until March 2013

Lattoflex 300 spring element



supporting strip, pale grey

Please state frame type, model year and width with order

**Attention! Special supporting strips are needed for the shoulder zone**



to 100 cm  
to 120 cm  
to 140 cm

Lattoflex 300 spring element/shoulder



Supporting strip end caps



Lattoflex 300 wing element

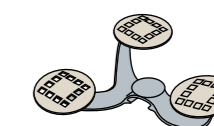

**All other spare parts on request, also for older frames.**

# Lattoflex mattresses:

Lattoflex's basic idea of offering one mattress core in modules of different strengths has proven its worth now for more than 10 years. This modular cut offers the inclined body exactly the support it needs.

Five mattress cores cover almost all the comfort demands made by customers. The Conform mattress core is an exclusive feature in the Lattoflex-Schlafwerk bed system. It permits individual customised fabrication to give the customer maximum comfort.

The current generation of Lattoflex mattresses is cuddlier, more comfortable, thicker, more permeable and variable than ever before. Nearly all covers are now available in two finishes: climate stripe or climate border.

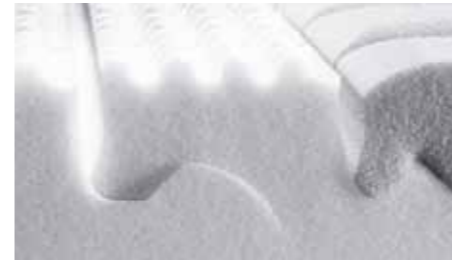

## ClimaCell® from Lattoflex:

ClimaCell® was specifically developed for Lattoflex. The material is known for high point-elasticity, extremely good breathing properties and optimum suitability for persons allergic to household dust.



All Lattoflex mattresses and the neck supporting cushions have been inspected in accordance with the Öko-Tex Standard 100. Accordingly, the certified human-ecological harmlessness refers, of course, also to the ClimaCell® mattress cores or the cushion fillings.



## The top model Lattoflex Conform:

With the Evometer, the individual arrangement of the zones is determined quickly and precisely. A corresponding Conform mattress is then manufactured at Lattoflex. A selection of many different covers is available for all comfort requirements.

## For a pleasant lying feeling:

The new surface section increases the affectionate nature and creates a noticeable improved feeling. The thereby improved, extraordinary point-elasticity ensures an ideal adaptation to the body. The material is extremely breathable and is thereby responsible for the typical dry-warm bed climate of Lattoflex mattresses.



## Optimum adaptation:

Due to the extremity-shaped cut and the loosened-up surface, these mattresses adapt themselves ideally to suit the body contour of the lying person. And the lack of surface tension is also experienced as being extremely pleasant by lightweight persons, too. These properties make our Lattoflex mattresses the ideal supplement for our Comfort sitting frames.

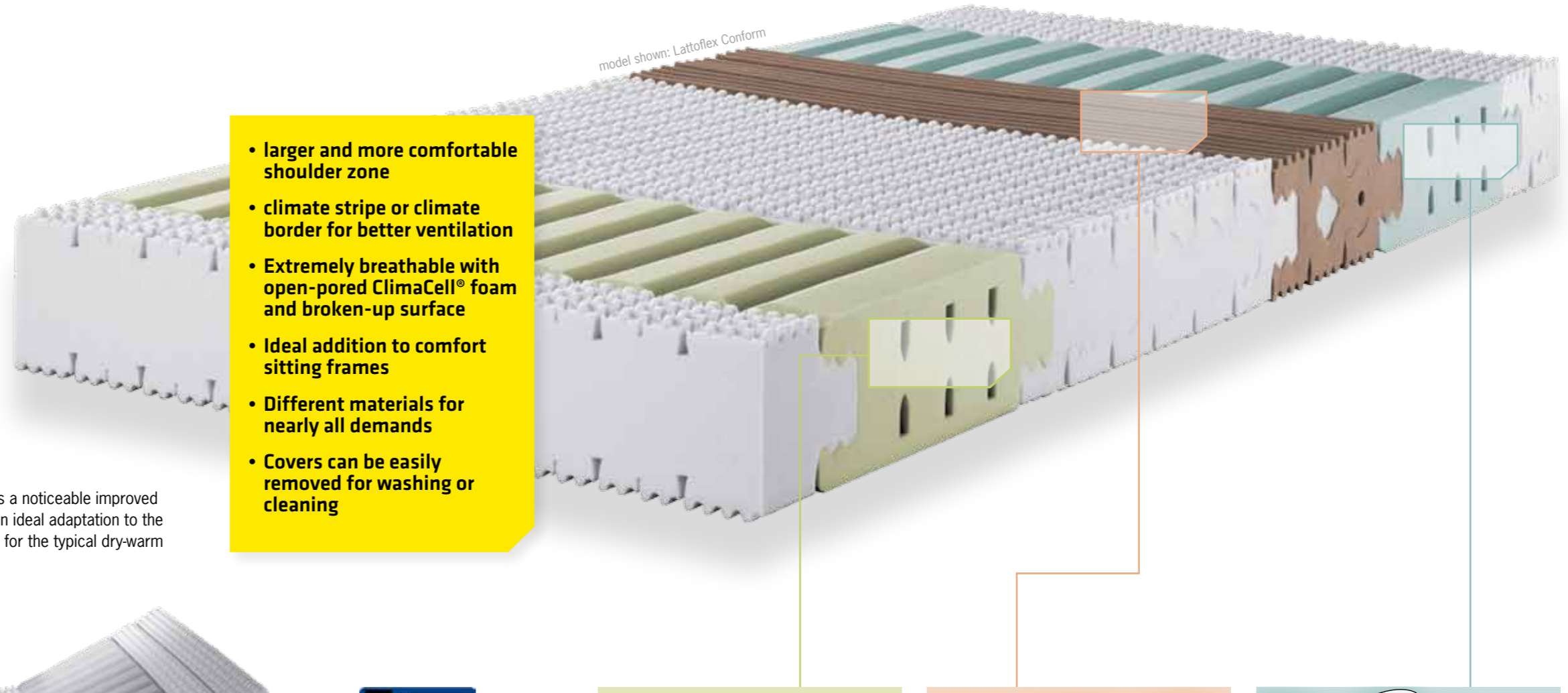

The Lattoflex bed system has been inspected and is recommended by the Bundesverband der deutschen Rückenschulen e.V. and the Forum Gesunder Rücken – besser leben e.V.

For further information on the quality seal of AGR e.V., write to: P.O. Box 103 27443 Selsingen/Germany Internet: www.agr-ev.de

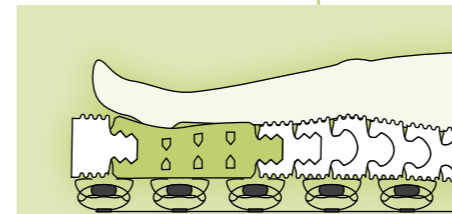

## Heel zone

A small detail works wonders: The especially soft zone in the heel area – also capable of being positioned according to made-to-measure specifications.

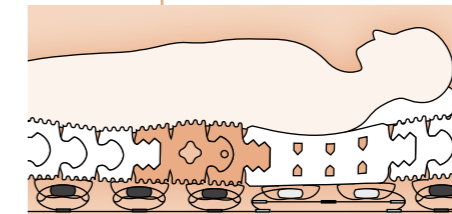

## Lumbar zone

Correct positioning of the spinal column and support for the lumbar region – ideal prerequisites for avoiding back problems. A firm core in the middle of the lumbar zone provides the necessary support, while the cover material still gives a soft feel.

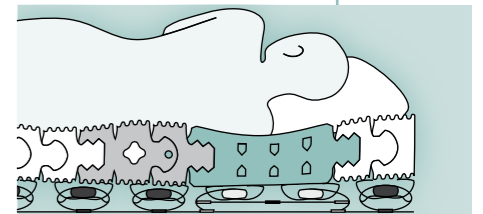

## Shoulder zone

An exactly positioned shoulder zone lets the shoulders sink pleasantly into the mattress – a very pleasant feeling when lying on the side. The new longitudinal and cross channels allow for better exchange of air to improve the climate aspects. Side effect: more sensitive sinking in of the shoulders.

## Classic 1



The two Classic mattress cores are the entry level price category and available in two different hardnesses. Classic 1 is the soft version.

The basic models also have the elaborate limbs cut with excellent functionality particularly on adjustable frames. The shoulder zone is integrated in the cut while the proven climate wave on the surface provides for relaxed lying and sleeping.

### Material

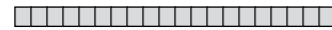

Mattress core: ClimaCell®, Tricot knitted fabric: 100 % polyester  
Core height: approx. 17 cm

## Classic 2



The two Classic mattress cores are the entry level price category and available in two different hardnesses. Classic 2 is the firm version.

The basic models also have the elaborate limbs cut with excellent functionality particularly on adjustable frames. The shoulder zone is integrated in the cut while the proven climate wave on the surface provides for relaxed lying and sleeping.

### Material



Mattress core: ClimaCell®, Tricot knitted fabric: 100 % polyester  
Core height: approx. 17 cm

## Compact



Meant for persons who like a more firm mattress. The comfortable shoulder zone ensures a pleasant sinking-in when sleeping on the side. This is felt explicitly due to the firmer middle part of the core.

### Material



Mattress core: ClimaCell®, Tricot knitted fabric: 100 % polyester  
Core height: approx. 17 cm

## Conform

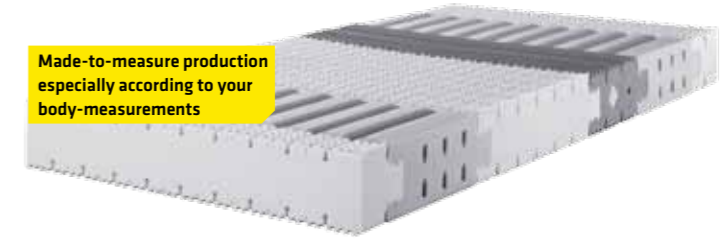

Made-to-measure production especially according to your body-measurements

The asymmetrical form of the Conform core provides the model for a mattress, which is produced according to the body measurements as individual piece. With the measuring bar Evometer the position of shoulder, loins and heels zone is measured and determined where they have to be placed. Thereby, it is also defined, how long the mattress has to be. After it has been decided on the cover, the Lattoflex mattress made-to-measure is produced: Conform.

### Material



Mattress core: ClimaCell®, Tricot knitted fabric: 100 % polyester  
Core height: approx. 17 cm

## Sensiv



Our softest core is especially meant for petite, slim and lightweight people with sensible sleeping needs. Shoulder zone for pleasant sinking-in of the shoulder, especially when lying on the side.

### Material

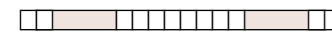

Mattress core: ClimaCell®, Tricot knitted fabric: 100 % polyester  
Core height: approx. 17 cm

## Medium



With its firmer middle part than the Sensiv core, the Lattoflex Medium core is the first choice for many people. Shoulder zone for pleasant sinking-in of the shoulder, especially when lying on the side.

### Material



Mattress core: ClimaCell®, Tricot knitted fabric: 100 % polyester  
Core height: approx. 17 cm

## Jersey J



Extremely point-elastic Jersey material in valuable optic. Heavy "double-cloth" quality.

### Features:

zipper 2-side

**Overall height:** approx. 17 cm

### Cover fabric:

70 % polyester, 30 % viscose (bamboo), washable 60°C/140°F, not suitable for drier

## Please note:

### Oversize widths with double beds

Please note when purchasing: Mattresses with oversize widths (160, 180, 200 cm) are very unhandy and unsuitable for adjustable frames. Even head adjustments can no longer be adjusted to individual requirements. Your customer will also need bed linen/fixen sheets in special sizes.

### Special widths exceeding 160 cm include two individual mattress cores in one cover.

### Make sure the mattress matches the inlay frame.

When using a new mattress on an old, used frame, the mattress could become damaged in a relatively short period of time. In case of such a combination, no warranty claims can be asserted.

extra soft  soft  medium firm  firm  shoulder zone

## Standard dimensions

lengths cm	190/200	width cm	80/90/95/100	120	140	70-100	101-120	121-140	141-160	161-200
------------	---------	----------	--------------	-----	-----	--------	---------	---------	---------	---------

Special lengths up to 200 cm at no extra cost. Extra cost for special lengths (with all widths) between 200 and 220 cm. **Curved mattresses at extra cost.** Please specify the precise radius or send us pattern.

## Special dimensions Please provide precise bed inside measurements

lengths cm	190/200	width cm	80/90/95/100	120	140	70-100	101-120	121-140	141-160	161-200
------------	---------	----------	--------------	-----	-----	--------	---------	---------	---------	---------

## Jersey IS with climate stripe



A synthetic cover stitched with comfort pad foam, due to its washability (up to 60°C/140°F) also ideal for persons allergic to household dust and persons suffering from asthma. Here we use a fibre that distributes the moisture on the fibre surface and lets it evaporate very quickly. This property is maintained for a long time even after washing the material frequently. Accordingly, we have succeeded in giving the synthetic fibre a "natural feeling". The included carbon fibre has an antistatic and dust repelling effect.

### Features:

4 robust turning handles, zipper all the way round, climate stripe

**Overall height:** approx. 20 cm

### Cover fabric:

Outer material: 45 % polyamide, 35 % viscose (bamboo), 20 % polyester  
 Stitched filling: 550 g/m<sup>2</sup> comfort pad PU-foam  
 Bottom fabric: 100 % polyamide  
 washable at 60°C/140°F, not suitable for drier

### Standard dimensions

lengths cm	190/200	width cm	80/90/95/100	120	140	70-100	101-120	121-140	141-160	161-200
------------	---------	----------	--------------	-----	-----	--------	---------	---------	---------	---------

Special lengths up to 200 cm at no extra cost. Extra cost for special lengths (with all widths) between 200 and 220 cm.

**Curved mattresses at extra cost.** Please specify the precise radius or send us pattern.

### Special dimensions Please provide precise bed inside measurements

## Jersey CS with climate stripe



Cover material that is pleasant to touch thanks to top quality cashmere fibres. The material also includes carbon threads that have an anti-static and dust-repellent effect.

### Features:

4 robust turning handles, zipper all the way round, climate border

**Overall height:** approx. 20 cm

### Cover fabric:

Outer material: 56 % polyester, 35 % viscose (bamboo), 6 % cashmere, 3 % polyamide  
 Stitched filling: 550 g/m<sup>2</sup> comfort pad PU-foam  
 Bottom fabric: 100 % polyamide  
 washable at 60°C/140°F, not suitable for drier

### Standard dimensions

lengths cm	190/200	width cm	80/90/95/100	120	140	70-100	101-120	121-140	141-160	161-200
------------	---------	----------	--------------	-----	-----	--------	---------	---------	---------	---------

Special lengths up to 200 cm at no extra cost. Extra cost for special lengths (with all widths) between 200 and 220 cm.

**Curved mattresses at extra cost.** Please specify the precise radius or send us pattern.

### Special dimensions Please provide precise bed inside measurements

## Jersey IS with climate border



A synthetic cover stitched with comfort pad foam, due to its washability (up to 60°C/140°F) also ideal for persons allergic to household dust and persons suffering from asthma. Here we use a fibre that distributes the moisture on the fibre surface and lets it evaporate very quickly. This property is maintained for a long time even after washing the material frequently. Accordingly, we have succeeded in giving the synthetic fibre a "natural feeling". The included carbon fibre has an antistatic and dust repelling effect.

### Features:

4 robust turning handles, zipper all the way round, climate border

**Overall height:** approx. 20 cm

### Cover fabric:

Outer material: 45 % polyamide, 35 % viscose (bamboo), 20 % polyester  
 Stitched filling: 550 g/m<sup>2</sup> comfort pad PU-foam  
 Bottom fabric: 100 % polyamide  
 washable at 60°C/140°F, not suitable for drier

### Standard dimensions

lengths cm	190/200	width cm	80/90/95/100	120	140	70-100	101-120	121-140	141-160	161-200
------------	---------	----------	--------------	-----	-----	--------	---------	---------	---------	---------

Special lengths up to 200 cm at no extra cost. Extra cost for special lengths (with all widths) between 200 and 220 cm.

**Curved mattresses at extra cost.** Please specify the precise radius or send us pattern.

### Special dimensions Please provide precise bed inside measurements

## Jersey CS with climate border



Cover material that is pleasant to touch thanks to top quality cashmere fibres. The material also includes carbon threads that have an anti-static and dust-repellent effect.

### Features:

4 robust turning handles, zipper all the way round, climate border

**Overall height:** approx. 20 cm

### Cover fabric:

Outer material: 56 % polyester, 35 % viscose (bamboo), 6 % cashmere, 3 % polyamide  
 Stitched filling: 550 g/m<sup>2</sup> comfort pad PU-foam  
 Bottom fabric: 100 % polyamide  
 washable at 60°C/140°F, not suitable for drier

### Standard dimensions

lengths cm	190/200	width cm	80/90/95/100	120	140	70-100	101-120	121-140	141-160	161-200
------------	---------	----------	--------------	-----	-----	--------	---------	---------	---------	---------

Special lengths up to 200 cm at no extra cost. Extra cost for special lengths (with all widths) between 200 and 220 cm.

**Curved mattresses at extra cost.** Please specify the precise radius or send us pattern.

### Special dimensions Please provide precise bed inside measurements

## Climate jersey K with climate stripe



Snug climate jersey. Due to its washability, also excellently suitable for persons allergic to household dust and persons suffering from asthma. This cover offers extreme point elasticity. Excellent climatizing effect.

### Features:

4 robust turning handles, zipper all the way round, climate stripe

**Overall height:** approx. 17 cm

### Cover fabric:

Lying surface: 100 % cotton  
Intermediate layer: 100 % polyamide  
Bottom side: 100 % polyester  
Textile labeling: 60 % polyamide, 20 % polyester, 20 % cotton  
washable 60°C/140°F, not suitable for drier

### Standard dimensions

### Special dimensions Please provide precise bed inside measurements

lengths cm	190/200	width cm	80/90/95/100	120	140	70-100	101-120	121-140	141-160	161-200
------------	---------	----------	--------------	-----	-----	--------	---------	---------	---------	---------

Special lengths up to 200 cm at no extra cost. Extra cost for special lengths (with all widths) between 200 and 220 cm.

**Curved mattresses at extra cost.** Please specify the precise radius or send us pattern.

## Climate jersey K with climate border



Snug climate jersey. Due to its washability, also excellently suitable for persons allergic to household dust and persons suffering from asthma. This cover offers extreme point elasticity. Excellent climatizing effect.

### Features:

4 robust turning handles, zipper all the way round, climate border

**Overall height:** approx. 17 cm

### Cover fabric:

Lying surface: 100 % cotton  
Intermediate layer: 100 % polyamide  
Bottom side: 100 % polyester  
Textile labeling: 60 % polyamide, 20 % polyester, 20 % cotton  
washable 60°C/140°F, not suitable for drier

### Standard dimensions

### Special dimensions Please provide precise bed inside measurements

lengths cm	190/200	width cm	80/90/95/100	120	140	70-100	101-120	121-140	141-160	161-200
------------	---------	----------	--------------	-----	-----	--------	---------	---------	---------	---------

Special lengths up to 200 cm at no extra cost. Extra cost for special lengths (with all widths) between 200 and 220 cm.

**Curved mattresses at extra cost.** Please specify the precise radius or send us pattern.

## Velours VS with climate stripe



Cosy-soft velours stitched together with comfort pad foam in order to guarantee its washability (suitable for persons allergic to household dust and persons suffering from asthma).

### Features:

4 robust turning handles, zipper all the way round, climate stripe

**Overall height:** approx. 20 cm

### Cover fabric:

Outer material: 53 % viscose (bamboo), 25 % polyester, 22 % cotton  
Stitched filling: 550 g/m<sup>2</sup> comfort pad PU-foam  
Bottom fabric: 100 % polyamide  
washable at 60°C/140°F, not suitable for drier

### Standard dimensions

### Special dimensions Please provide precise bed inside measurements

lengths cm	190/200	width cm	80/90/95/100	120	140	70-100	101-120	121-140	141-160	161-200
------------	---------	----------	--------------	-----	-----	--------	---------	---------	---------	---------

Special lengths up to 200 cm at no extra cost. Extra cost for special lengths (with all widths) between 200 and 220 cm.

**Curved mattresses at extra cost.** Please specify the precise radius or send us pattern.

## Velours VS with climate border



Cosy-soft velours stitched together with comfort pad foam in order to guarantee its washability (suitable for persons allergic to household dust and persons suffering from asthma).

### Features:

4 robust turning handles, zipper all the way round, climate border

**Overall height:** approx. 20 cm

### Cover fabric:

Outer material: 53 % viscose (bamboo), 25 % polyester, 22 % cotton  
Stitched filling: 550 g/m<sup>2</sup> comfort pad PU-foam  
Bottom fabric: 100 % polyamide  
washable at 60°C/140°F, not suitable for drier

### Standard dimensions

### Special dimensions Please provide precise bed inside measurements

lengths cm	190/200	width cm	80/90/95/100	120	140	70-100	101-120	121-140	141-160	161-200
------------	---------	----------	--------------	-----	-----	--------	---------	---------	---------	---------

Special lengths up to 200 cm at no extra cost. Extra cost for special lengths (with all widths) between 200 and 220 cm.

**Curved mattresses at extra cost.** Please specify the precise radius or send us pattern.

## Jersey CW with climate stripe



Cover material that is pleasant to touch thanks to top quality cashmere fibres. The material also includes carbon threads that have an anti-static and dust-repellent effect. The cover material is quilted with a luxuriant fleece filling. The climate-regulating wool fleece and silk fleece turn the CW cover into a special-category mattress cover.

### Features:

4 robust turning handles, zipper all the way round, climate stripe

**Overall height:** approx. 20 cm

### Cover fabric:

Outer material: 56 % polyester, 35 % viscose (bamboo), 6 % cashmere, 3 % polyamide  
 Stitched fleece filling: 550 g/m<sup>2</sup> wool fleece (85 % new wool, 15 % polyester climate fibre) and 100 g/m<sup>2</sup> silk fleece (95 % silk, 5 % polyester climate fibre)  
 Bottom fabric: 100 % cotton  
 suitable for dry-cleaning

### Standard dimensions

lengths cm	190/200	width cm	80/90/95/100	120	140	70-100	101-120	121-140	141-160	161-200
------------	---------	----------	--------------	-----	-----	--------	---------	---------	---------	---------

Special lengths up to 200 cm at no extra cost. Extra cost for special lengths (with all widths) between 200 and 220 cm.

**Curved mattresses at extra cost.** Please specify the precise radius or send us pattern.

### Special dimensions Please provide precise bed inside measurements

## Jersey CW with climate border



Cover material that is pleasant to touch thanks to top quality cashmere fibres. The material also includes carbon threads that have an anti-static and dust-repellent effect. The cover material is quilted with a luxuriant fleece filling. The climate-regulating wool fleece and silk fleece turn the CW cover into a special-category mattress cover.

### Features:

4 robust turning handles, zipper all the way round, climate border

**Overall height:** approx. 20 cm

### Cover fabric:

Outer material: 56 % polyester, 35 % viscose (bamboo), 6 % cashmere, 3 % polyamide  
 Stitched fleece filling: 550 g/m<sup>2</sup> wool fleece (85 % new wool, 15 % polyester climate fibre) and 100 g/m<sup>2</sup> silk fleece (95 % silk, 5 % polyester climate fibre)  
 Bottom fabric: 100 % cotton  
 suitable for dry-cleaning

### Standard dimensions

lengths cm	190/200	width cm	80/90/95/100	120	140	70-100	101-120	121-140	141-160	161-200
------------	---------	----------	--------------	-----	-----	--------	---------	---------	---------	---------

Special lengths up to 200 cm at no extra cost. Extra cost for special lengths (with all widths) between 200 and 220 cm.

**Curved mattresses at extra cost.** Please specify the precise radius or send us pattern.

### Special dimensions Please provide precise bed inside measurements

## Lattoflex Mattress TOP



The TOP mattress is geared to uncompromising comfort. The inside consists of a Lattoflex mattress core (approx. 17 cm) in the required design and hardness (Sensitive, Medium, Compact or Conform). The whole thing is rounded off by an integrated topper coat (approx. 9 cm). Both cores are bound together by an elaborate mattress cover. A comfort padding quilt foam and a quilt fleece are integrated under the top material. The material in turn creates the dot quilting with a fluffy effect. The integrated cashmere fibres give the material a good grip while the carbon threads have an anti-static and dust-repellent effect.

### Features:

Separate pockets in the interior for mattress core and topper core. Two peripheral zip fasteners. Stitched border with 4 robust turning handles.

**Overall height:** approx. 29 cm

### Cover fabric:

Outer material: 56 % polyester, 35 % viscose (bamboo), 6 % cashmere, 3 % polyamide  
 Stitched fleece filling 850 g/m<sup>2</sup>:  
 550 g/sm comfort padding PU foam and 300 g/m<sup>2</sup> quilt fleece (100 % polyester climate fibre)  
 Bottom fabric: 100 % polyamide  
 Border: 100 % polyester, quilted with 225 g/m<sup>2</sup> comfort padding PU foam  
 Underside: 100 % polyester  
 washable 40° C, not suitable for drier

### Caution:

Pneumatic spring adjustment does not work perfectly in combination with spring base 370.  
 Please enquire about combination with spring base 351 (bedding box opening).

### Standard dimensions

lengths cm	190/200	width cm	80/90/95/100	120	140	70-100	101-120	121-140	141-160
------------	---------	----------	--------------	-----	-----	--------	---------	---------	---------

Special lengths up to 200 cm at no extra cost. Extra cost for special lengths (with all widths) between 200 and 220 cm.

### Special dimensions Please provide precise bed inside measurements

## We guarantee our Lattoflex bed system 300

We give you a guarantee of 10 years on the elastic spring elements, the wing elements and the supporting profiles. In case a spring element is deformed, a wing element or supporting profile broken, we will quickly deliver parts for replacement.

This 10-year guarantee is also valid for the ClimaCell® core of your new Lattoflex mattress. Consider the mattress core as being as good as new for the first three years. On making any guarantee payments after this period of time, a value loss of 10% per year of use is deducted from the purchase price. Please accept that the statutory warranty period applies to the mattress covers.

The motors of motor-powered spring base systems are covered by a 3-year guarantee promise. A 3-year guarantee period also applies to all other material or manufacturing defects.

As a general rule, damage due to improper handling, misuse, subsequent modifications or natural wear and tear, are excluded from the warranty. Unfortunately, we will have to charge you for any installation and freight costs incurred after the legal warranty period has expired.

If you have any cause for complaint, please consult your Lattoflex dealer, keeping your invoice and/or this guarantee statement at the ready.

Your dealer will get in touch with us on your behalf so that we can restore your satisfaction as quickly as possible.

We have always manufactured Lattoflex products conscientiously with all due care and attention, making every effort not to pollute the environment. All materials have been chosen to ensure that they will not create an ecological problem at the end of their service life.



the physiologically designed neck supporting cushion

### Lattokiss

This cushion is individually adjustable with respect to shape and supporting force. It supports your neck and relieves your especially sensitive neck vertebrae.

#### Dimension/Material

Dimension: approx. 35 x 80 cm  
Cover: 100 % cotton  
Filling: Microfibre 100 % polyester, 450 g washable 60°C/140°F, suitable for drier

Accessory: special cover PBF terry: 78 % cotton, 22 % polyester washable 60°C/140°F, suitable for drier



the Lattoflex 300 cushion

### MultiPerfekt

#### Dimension/Material

Dimension: approx. 40 x 70 cm  
Cover: 100 % cotton  
Filling: Microfibre 100 % polyester washable 60°C/140°F, suitable for drier  
Core: ClimaCell®

Accessory: special cover MPB terry: 78 % cotton, 22 % polyester washable 60°C/140°F, suitable for drier



the cushion with the bolster

### Traumfalter

We have folded the classic format 80 x 80 cm and fixed it with a zipper. In this condition, the cushion has the right volume. And for the support of the neck, you can insert either one or two bolsters.

#### Dimension/Material

Dimension: approx. 35 x 80 cm  
Cover: 100 % cotton  
Filling: Microfibre 100 % polyester, 480 g washable 60°C/140°F, suitable for drier

Accessory: special cover MPB terry: 78 % cotton, 22 % polyester washable 60°C/140°F, suitable for drier



The Lattoflex bed system has been inspected and is recommended by the Bundesverband der deutschen Rückenschulen e.V. and the Forum Gesunder Rücken – besser leben e.V.  
For further information on the quality seal of AGR e.V., write to:  
P.O. Box 103 · 27443 Selsingen/Germany  
Internet: [www.agr-ev.de](http://www.agr-ev.de)



Tested for harmful substances according to Oeko-Tex® Standard 100 A98-0331 Hohenstein

All Lattoflex mattresses and the neck supporting cushions have been inspected in accordance with the Oeko-Tex Standard 100. Accordingly, the certified human-ecological harmlessness refers, of course, also to the ClimaCell® mattress cores or the cushion fillings.



[www.lattoflex.com](http://www.lattoflex.com)

Thomas GmbH+Co. Sitz- und Liegemöbel KG · Postfach 1464 · 27424 Bremervörde · Germany  
Tel. + 49 (0) 4761/979-0 · Fax + 49 (0) 4761/979-161 · E-Mail: [info@lattoflex.com](mailto:info@lattoflex.com)